

# Appendices

---

**Appendix A:**  
ADA Path of Travel Assessment Diagrams

**Appendix B:**  
Facility Condition Assessment Reports

**Appendix C:**  
Hydrology Calculations

**Appendix D:**  
Water and Sewer Demand Calculations

**Appendix E:**  
Sewer Pipe Hydraulic Calculations

# SANTA BARBARA CITY COLLEGE

## ADA PATH OF TRAVEL ASSESSMENT

### SHEET INDEX:

- T-0 TITLE SHEET
- T-1 MAIN CAMPUS SITE KEY
  
- ME-0 MAIN CAMPUS - EAST CAMPUS EVACUATION SITES
- ME-1 MAIN CAMPUS - EAST CAMPUS EXISTING PARKING
- ME-2 MAIN CAMPUS - EAST CAMPUS ACCESSIBLE PARKING STALLS
- ME-3 MAIN CAMPUS - EAST CAMPUS CROSS SLOPES
- ME-4 MAIN CAMPUS - EAST CAMPUS CURB RAMPS
- ME-5 MAIN CAMPUS - EAST CAMPUS LONGITUDINAL SLOPES
- ME-6 MAIN CAMPUS - EAST CAMPUS PATH OF TRAVEL
- ME-7 MAIN CAMPUS - EAST CAMPUS POTENTIAL HAZARDOUS FEATURES
- ME-8 MAIN CAMPUS - EAST CAMPUS RAMPS AND STAIRS
- ME-9.1 TO ME-9.6  
MAIN CAMPUS - EAST CAMPUS OVERALL
  
- MW-0 MAIN CAMPUS - WEST CAMPUS EVACUATION SITES
- MW-1 MAIN CAMPUS - WEST CAMPUS EXISTING PARKING
- MW-2 MAIN CAMPUS - WEST CAMPUS ACCESSIBLE PARKING STALLS
- MW-3 MAIN CAMPUS - WEST CAMPUS CROSS SLOPES
- MW-4 MAIN CAMPUS - WEST CAMPUS CURB RAMPS
- MW-5 MAIN CAMPUS - WEST CAMPUS LONGITUDINAL SLOPES
- MW-6 MAIN CAMPUS - WEST CAMPUS PATH OF TRAVEL
- MW-7 MAIN CAMPUS - WEST CAMPUS POTENTIAL HAZARDOUS FEATURES
- MW-8 MAIN CAMPUS - WEST CAMPUS RAMPS AND STAIRS
- MW-9.0 MAIN CAMPUS - WEST CAMPUS SITE KEY
- MW-9.1 TO MW-9.3  
MAIN CAMPUS - WEST CAMPUS OVERALL
  
- SC-0 SCHOTT CENTER - CAMPUS MAP
- SC-1 SCHOTT CENTER - EXISTING PARKING
- SC-2 SCHOTT CENTER - ACCESSIBLE PARKING STALLS
- SC-3 SCHOTT CENTER - CROSS SLOPES
- SC-4 SCHOTT CENTER - CURB RAMPS
- SC-5 SCHOTT CENTER - LONGITUDINAL SLOPES
- SC-6 SCHOTT CENTER - PATH OF TRAVEL
- SC-7 SCHOTT CENTER - POTENTIAL HAZARDOUS FEATURES
- SC-8 SCHOTT CENTER - RAMPS AND STAIRS
- SC-9 SCHOTT CENTER - OVERALL

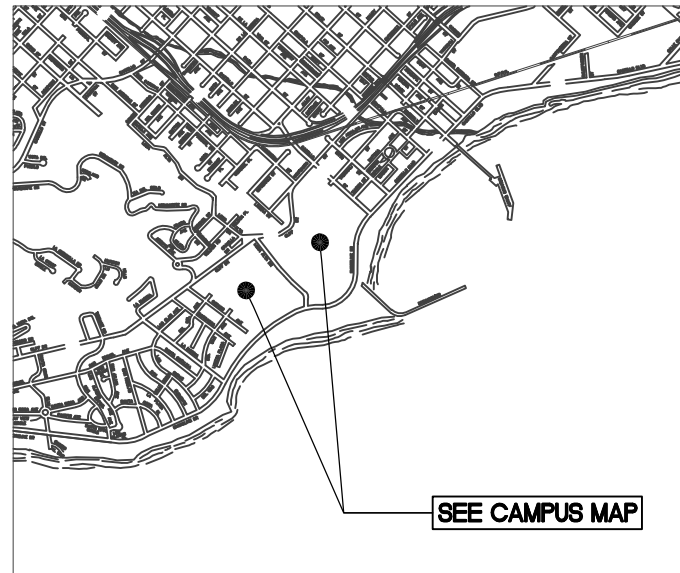

**VICINITY MAP**

MAIN CAMPUS  
721 CLIFF DRIVE  
SANTA BARBARA  
CA 93109-1673

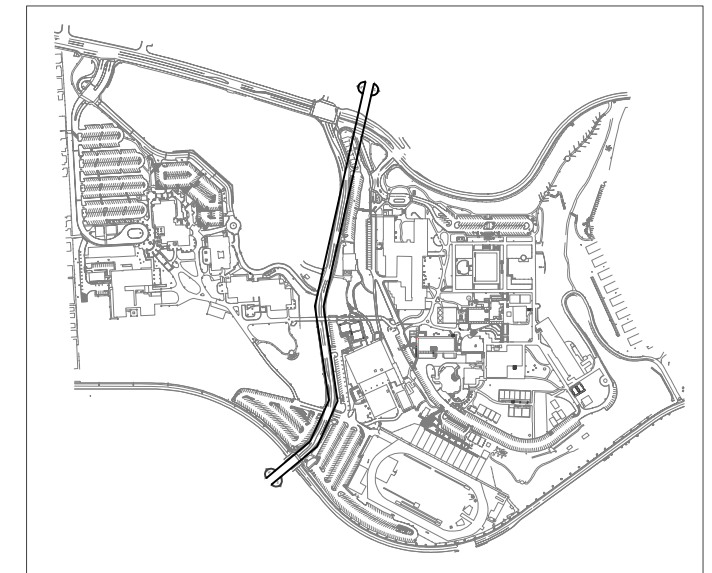

**CAMPUS MAP**

MAIN CAMPUS

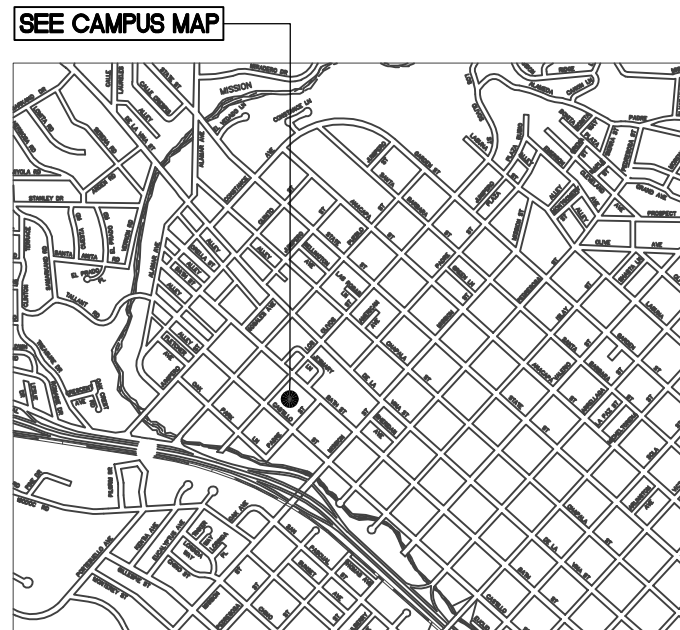

**VICINITY MAP**

SCHOTT CENTER  
310 W PADRE ST.  
SANTA BARBARA  
CA 93105-7100

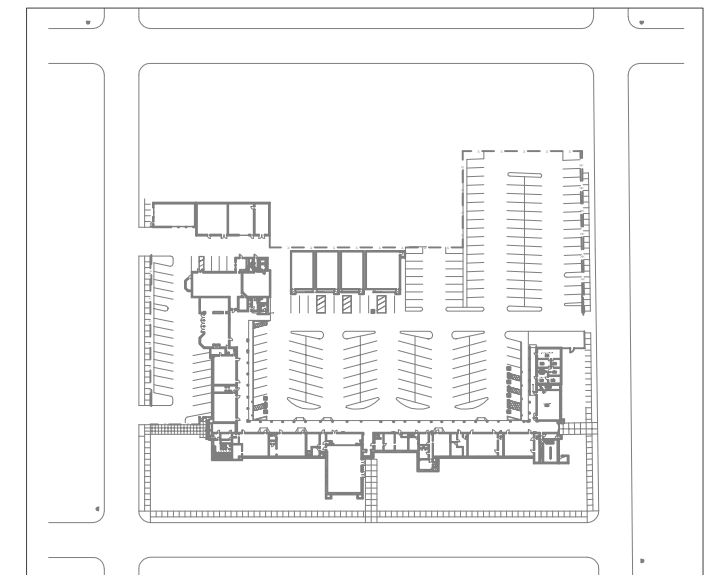

**CAMPUS MAP**

SCHOTT CENTER

**SHEET MW-9.1**

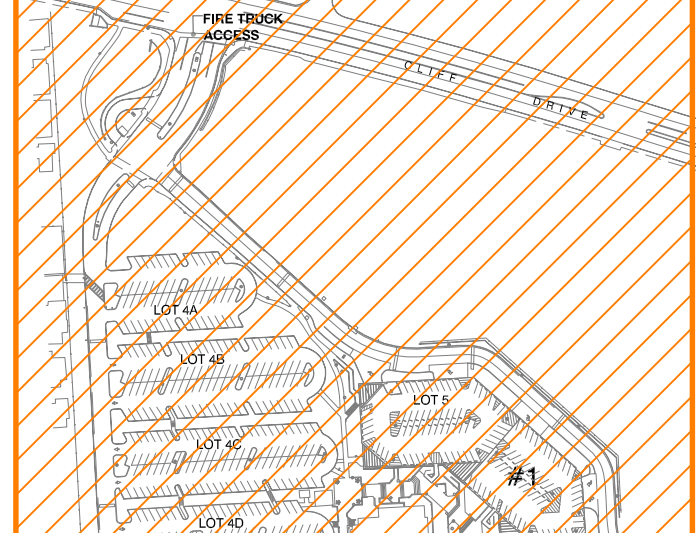

**SHEET ME-9.1**

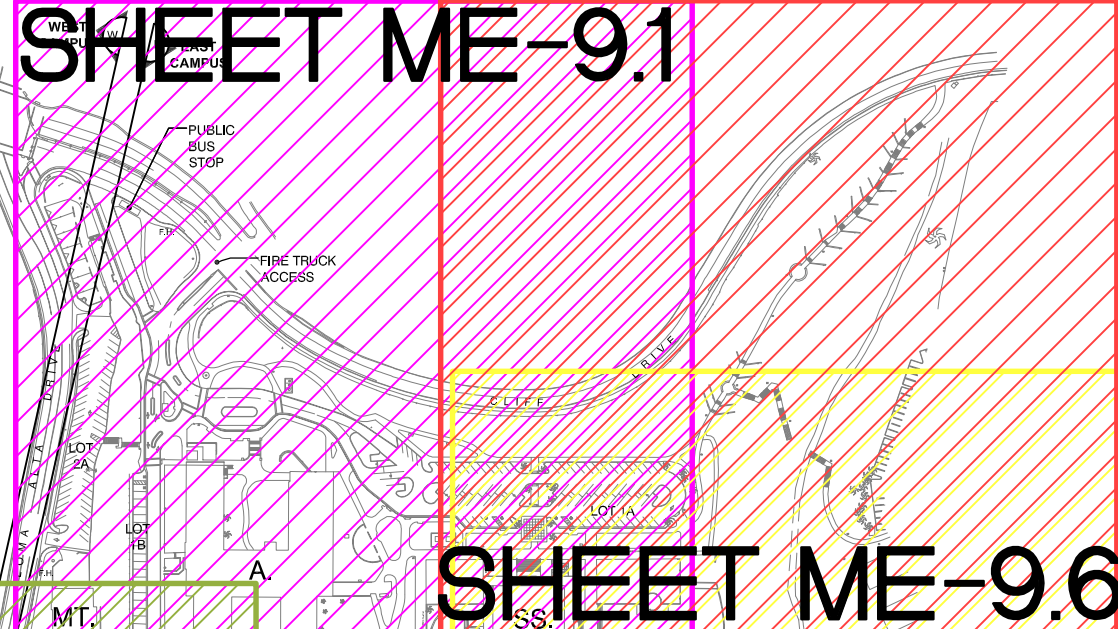

**SHEET MW-9.2**

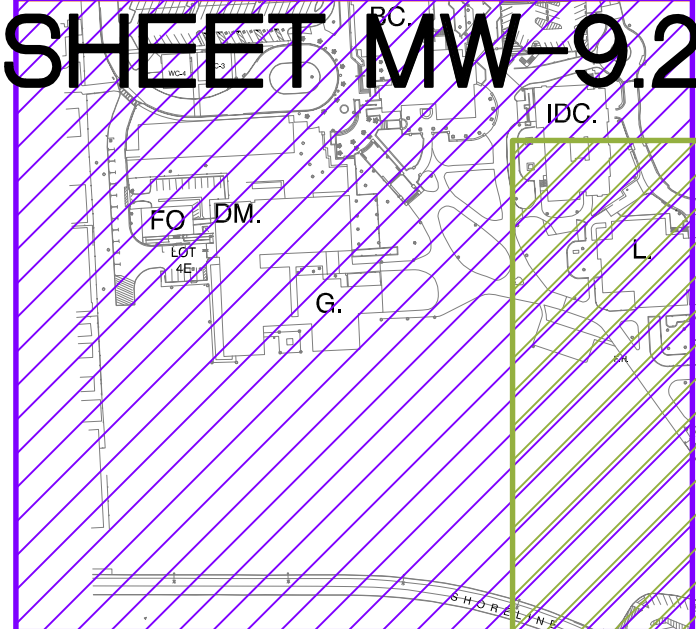

**SHEET ME-9.6**

**SHEET ME-9.2**

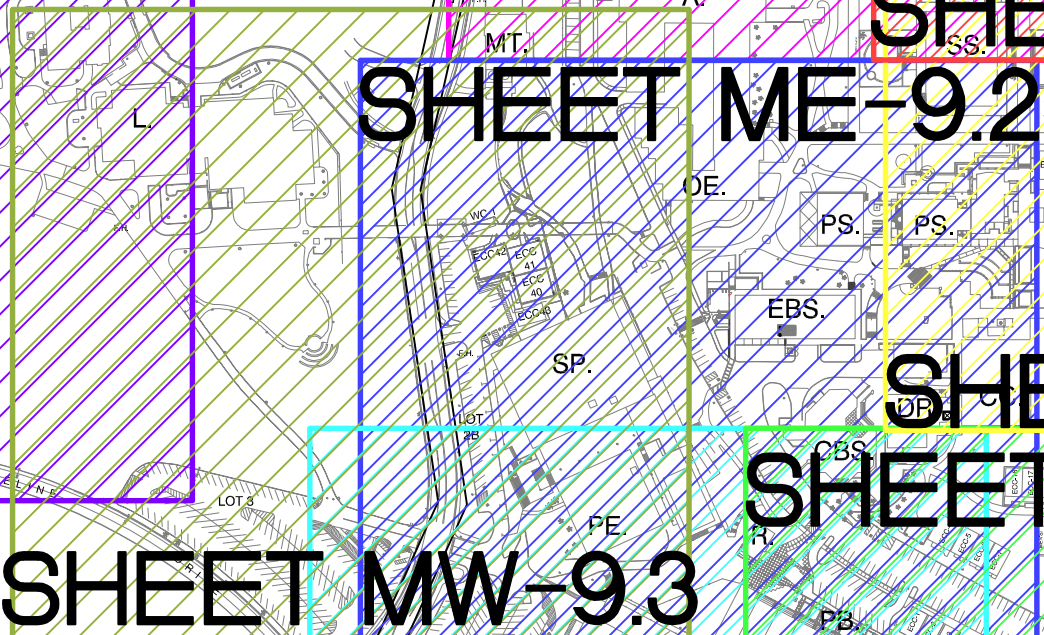

**SHEET ME-9.5**

**SHEET ME-9.4**

**SHEET MW-9.3**

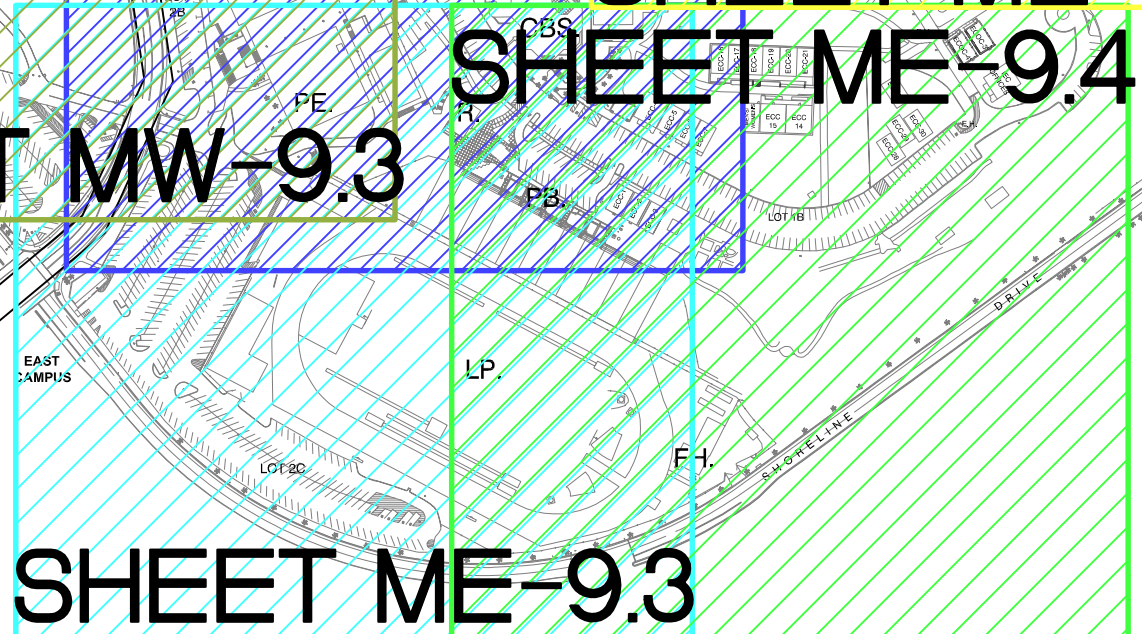

**SHEET ME-9.3**

**CAMPUS PLAN**

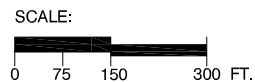

**RJC Inc.**  
Design & Construction Management

PO Box 60202  
SANTA BARBARA  
CA 93160-0202

Fax: (805)-585-3310  
Tel: (805) 692-9477  
Tel: (562)-392-8001  
E-mail: admin@rjc-inc.com



Main Campus  
Santa Barbara City College

721 CLIFF DRIVE  
SANTA BARBARA  
CA 93109-1673

**ADA PATH OF TRAVEL ASSESSMENT**  
**MAIN CAMPUS SITE KEY**

DATE: 2/19/16

**T-1**

# LEGEND

-  FIRE LANE
-  ADA PATH OF TRAVEL

# EVACUATION SITES

- ① FROM ADMINISTRATION BLDG, AUTOQUAD AND MARINE TECHNOLOGY
- ② FROM STUDENT SERVICE BLDG, ECOC 1 AND 2, FRC, PHYSICAL SCIENCE
- ③ FROM NORTH SIDE OF EBS BLDG, OE BLDG
- ④ FROM SOUTH SIDE OF EBS BLDG, BOOKSTORE, CAMPUS CENTER FIRST FLOOR, KAPLAN ASPECT, ECC BUILDINGS
- ⑤ FROM STADIUM FIELD, PE BUILDING ECC 41-44, VERY IMPORTANT TO GET TO HIGHER GROUND IN CASE OF TSUNAMI BROUGHT ON BY AN EARTHQUAKE
- ⑥ HUMANITIES BLDG, ECOC 3 AND 4, CAMPUS CENTER FIRST AND SECOND FLOOR, INTERNATIONAL OFFICE, ECC BLDGS, KAPLAN ASPECT
- ⑦ ALL BUILDINGS WEST CAMPUS
- ⑧ MEMBERS OF PRESIDENTS CABINET IN THE EVENT THAT A110 IS NOT REACHABLE

# EAST CAMPUS PLAN

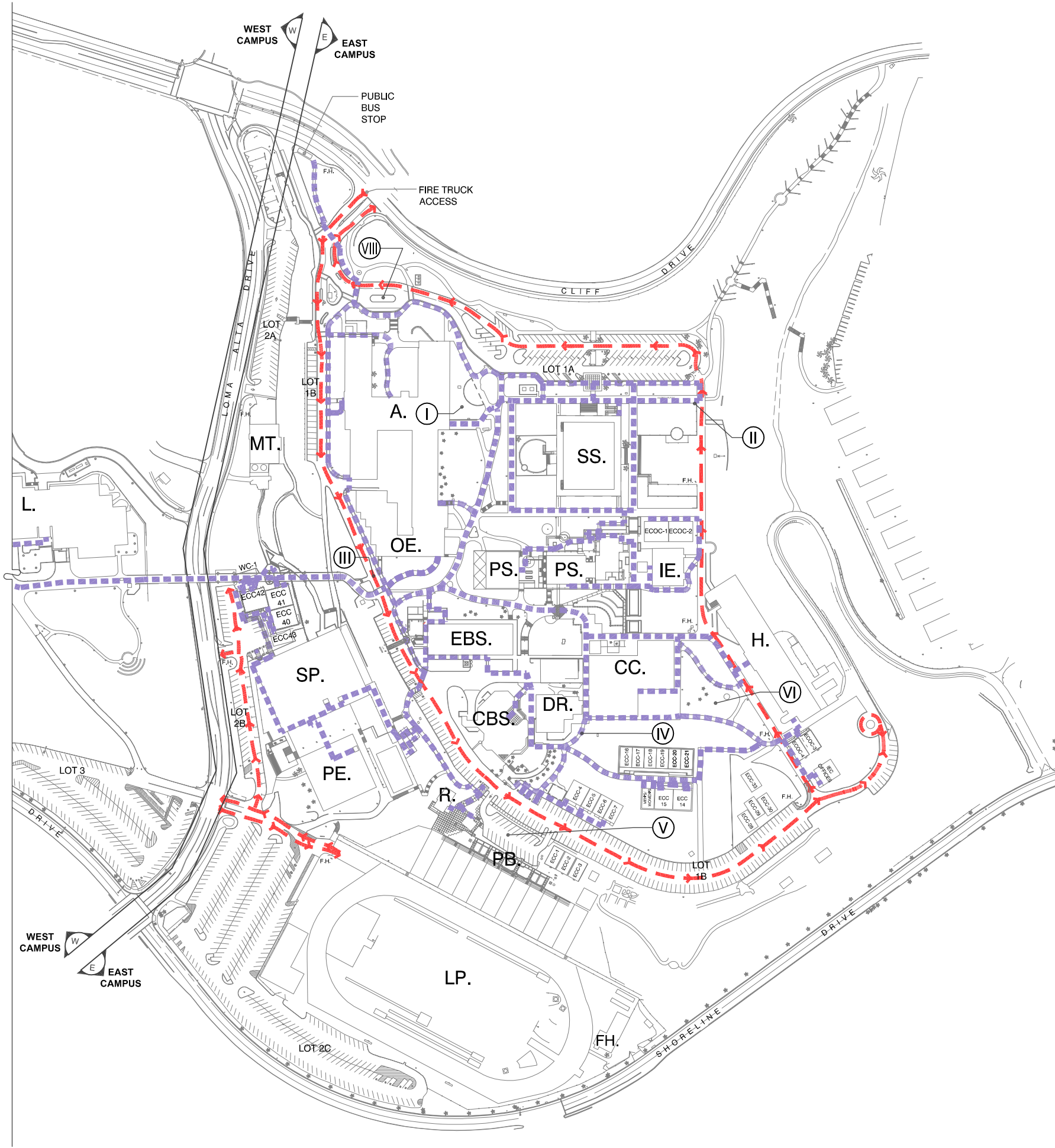
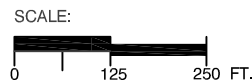

**RJC Inc.**  
Design & Construction Management

PO Box 60202  
SANTA BARBARA  
CA 93160-0202

Fax: (805)-585-3310  
Tel: (805) 692-9477  
Tel: (562)-392-8001  
E-mail: admin@rjc-inc.com



Main Campus - East Campus  
Santa Barbara City College





721 CLIFF DRIVE  
SANTA BARBARA  
CA 93109-1673

**ADA PATH OF TRAVEL ASSESSMENT  
EVACUATION SITES**

DATE: 2/19/16

**ME-0**

# LEGEND

-  EXISTING PEDESTRIAN BRIDGE
-  EXISTING FACILITIES
-  PARKING AREAS
-  FIRE LANE
-  ADA PATH OF TRAVEL

LOT#:	PARKING SPACES	ACCESSIBLE SPACES (1 VAN SPACE MIN.)	TOTAL SPACES PROVIDED	TOTAL ACCESSIBLE SPACES PROVIDED	TOTAL ACCESSIBLE SPACES REQUIRED
1A	94	2+2 VAN=4	98	4	4 (MIN.)
1B	213	9+2 VAN=11	224	11	7 (MIN.)
2A	57	0+0 VAN=0	57	0	3 (MIN.)
2B	43	4+1 VAN=5	48	5	2 (MIN.)
2C	315	7+1 VAN=8	323	8	8 (MIN.)
3	161	5+0 VAN=5	166	5	6 (MIN.)
4A-4D	329	5+3 VAN=8	337	8	8 (MIN.)
4E	16	2+1 VAN=3	19	3	1 (MIN.)
5	372	8+1 VAN=9	381	9	8 (MIN.)

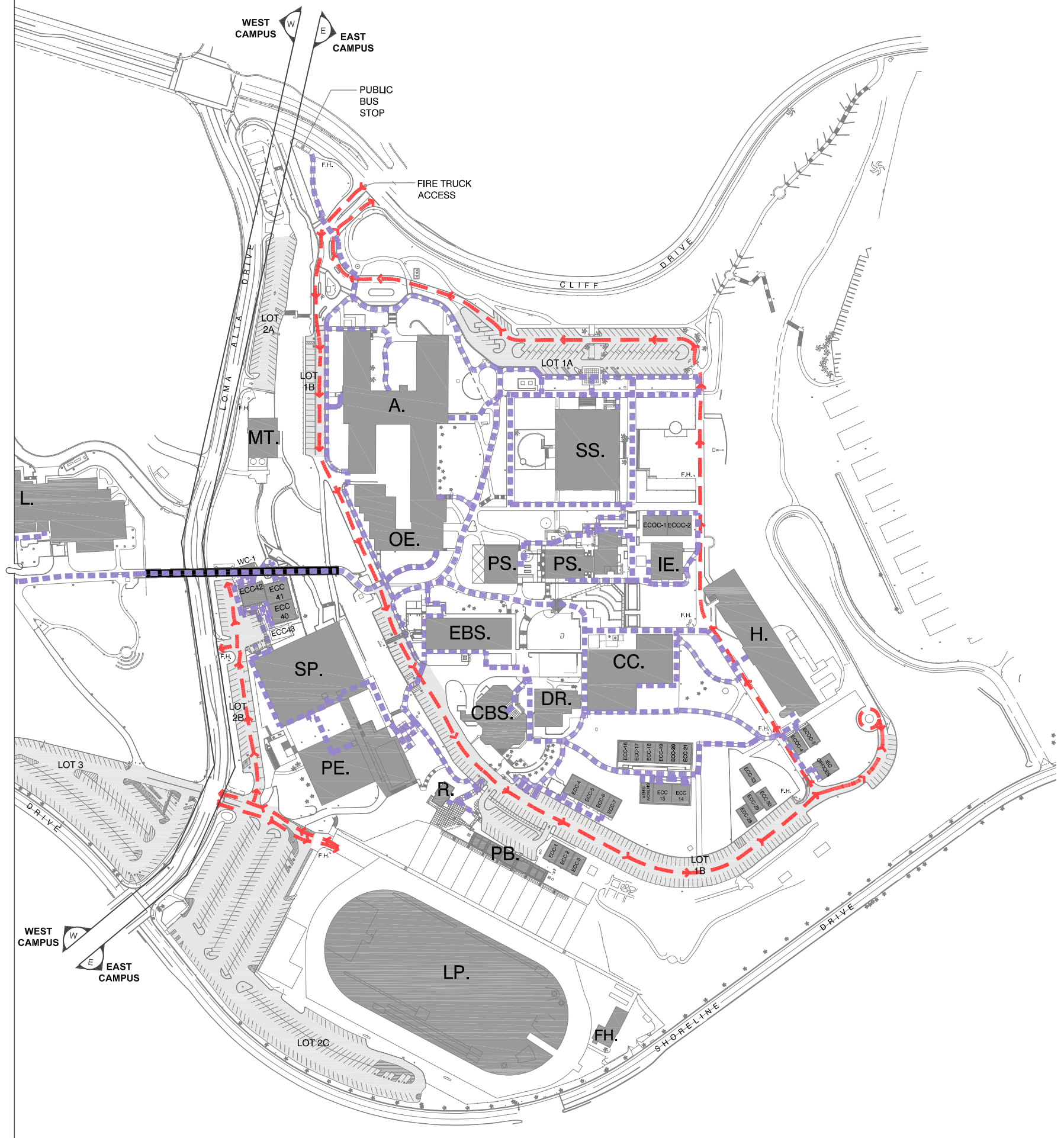

## EAST CAMPUS PLAN

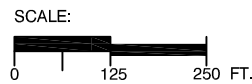

**RJC Inc.**  
Design & Construction Management

PO Box 60202  
SANTA BARBARA  
CA 93160-0202

Fax: (805)-585-3310  
Tel: (805) 692-9477  
Tel: (562)-392-8001  
E-mail: admin@rjc-inc.com



Main Campus - East Campus  
Santa Barbara City College

721 CLIFF DRIVE  
SANTA BARBARA  
CA 93109-1673

**ADA PATH OF TRAVEL ASSESSMENT**  
**EXISTING PARKING**

DATE: 2/19/16  
**ME-1**

# LEGEND

- ADA PARKING SLOPES EXCEED 2%
- FIRE LANE
- ADA PATH OF TRAVEL

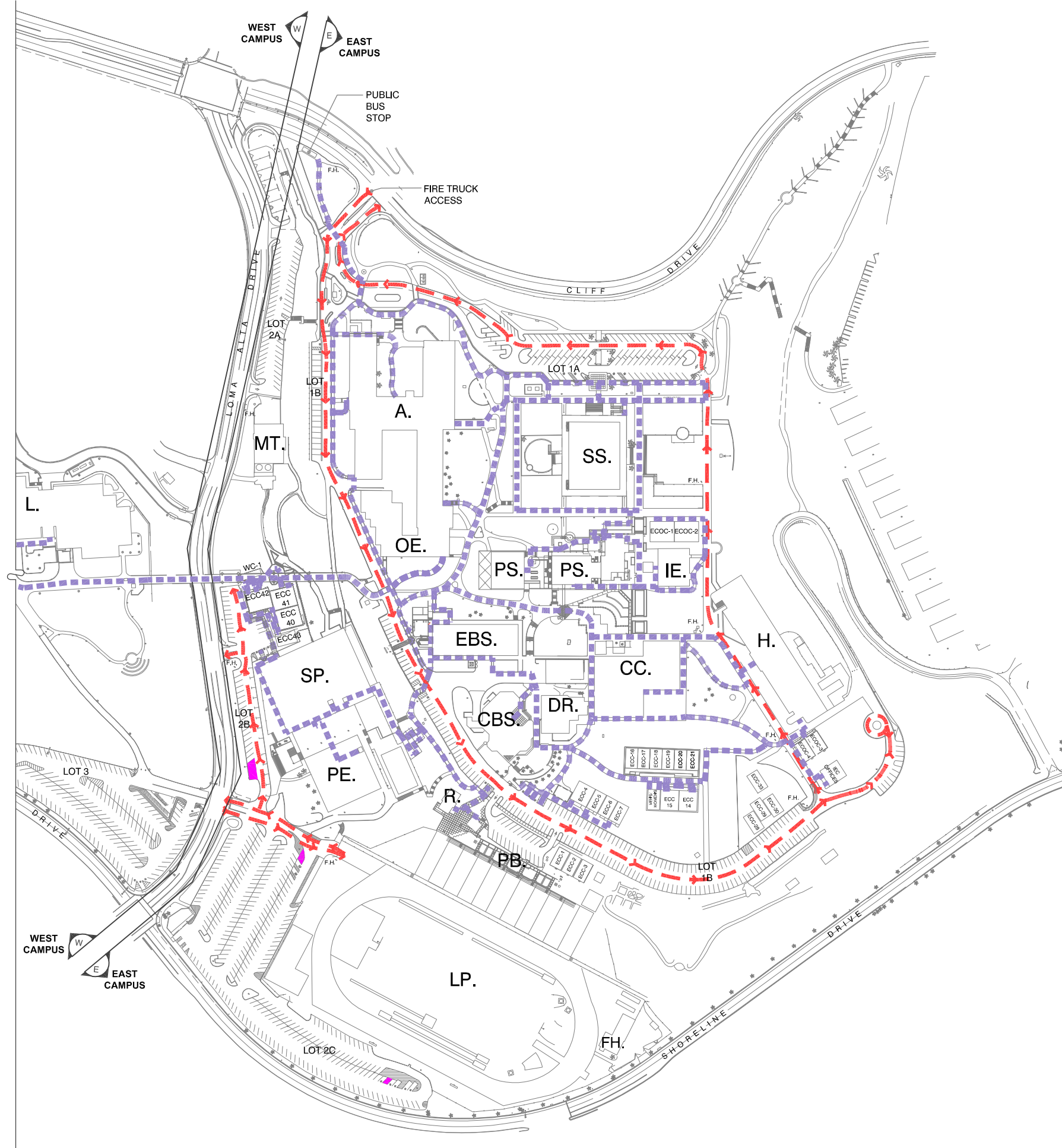

## EAST CAMPUS PLAN



**RJC Inc.**  
Design & Construction Management

PO Box 60202  
SANTA BARBARA  
CA 93160-0202

Fax: (805)-585-3310  
Tel: (805) 692-9477  
Tel: (562)-392-8001  
E-mail: admin@rjc-inc.com



Main Campus - East Campus  
Santa Barbara City College

721 CLIFF DRIVE  
SANTA BARBARA  
CA 93109-1673

**ADA PATH OF TRAVEL ASSESSMENT  
ACCESSIBLE PARKING STALLS**

DATE: 2/19/16

**ME-2**

# LEGEND

 CROSS SLOPE EXCEEDS 2% ALONG THE PATH OF TRAVEL

 FIRE LANE

 ADA PATH OF TRAVEL

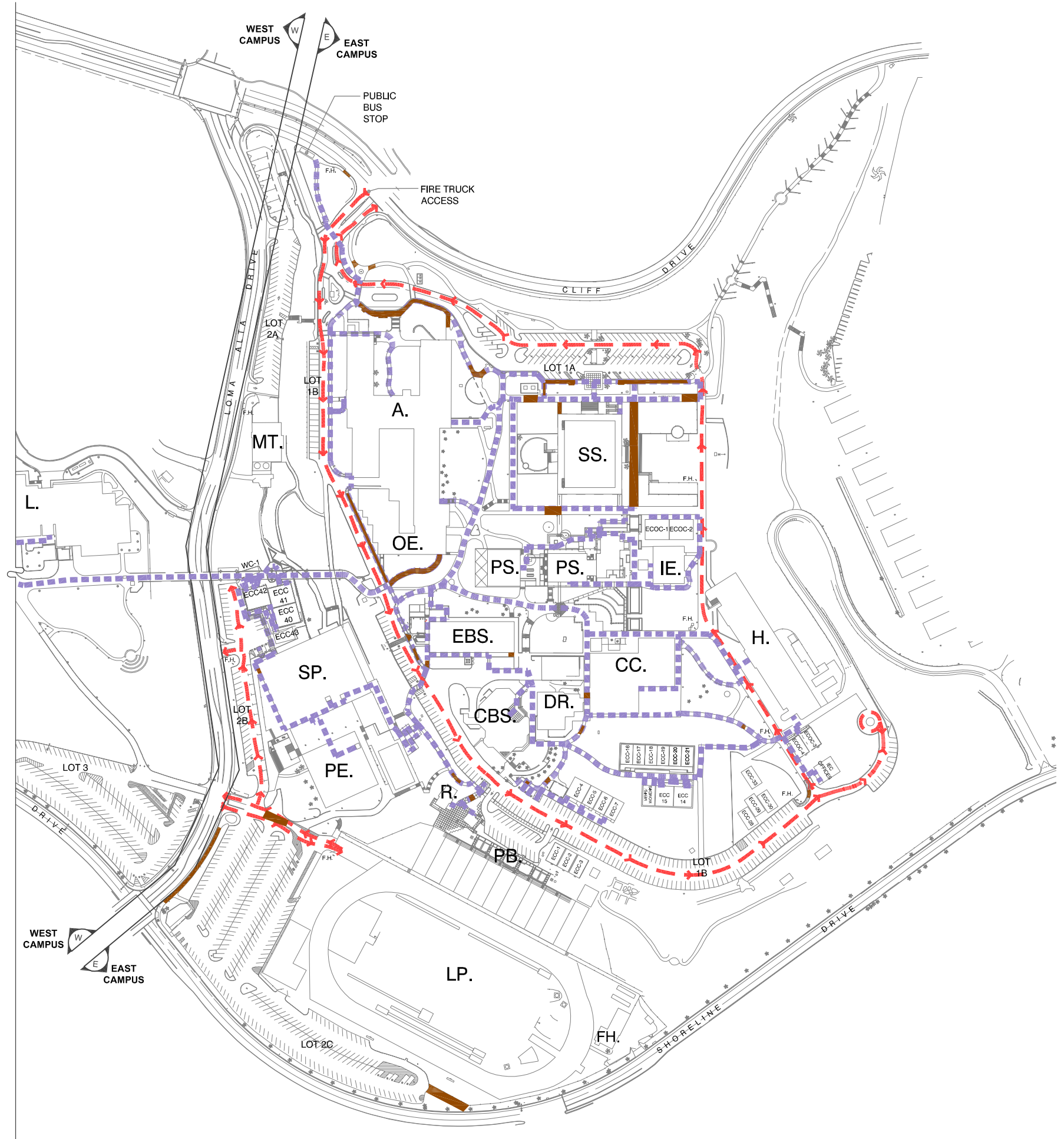

## EAST CAMPUS PLAN

SCALE:  
0 125 250 FT.



**RJC Inc.**  
Design & Construction Management

PO Box 60202  
SANTA BARBARA  
CA 93160-0202

Fax: (805)-585-3310  
Tel: (805) 692-9477  
Tel: (562)-392-8001  
E-mail: admin@rjc-inc.com



Main Campus - East Campus  
Santa Barbara City College

721 CLIFF DRIVE  
SANTA BARBARA  
CA 93109-1673

**ADA PATH OF TRAVEL ASSESSMENT**  
**CROSS SLOPES ALONG THE PATH OF TRAVEL**

DATE: 2/19/16

**ME-3**

# LEGEND

- INSUFFICIENT LANDING (SLOPE EXCEEDS 2%)
- \* NONCOMPLIANT CURB RAMP
- NO CURB RAMP OR REQUIRED RAMP MISSING
- ← FIRE LANE
- ADA PATH OF TRAVEL

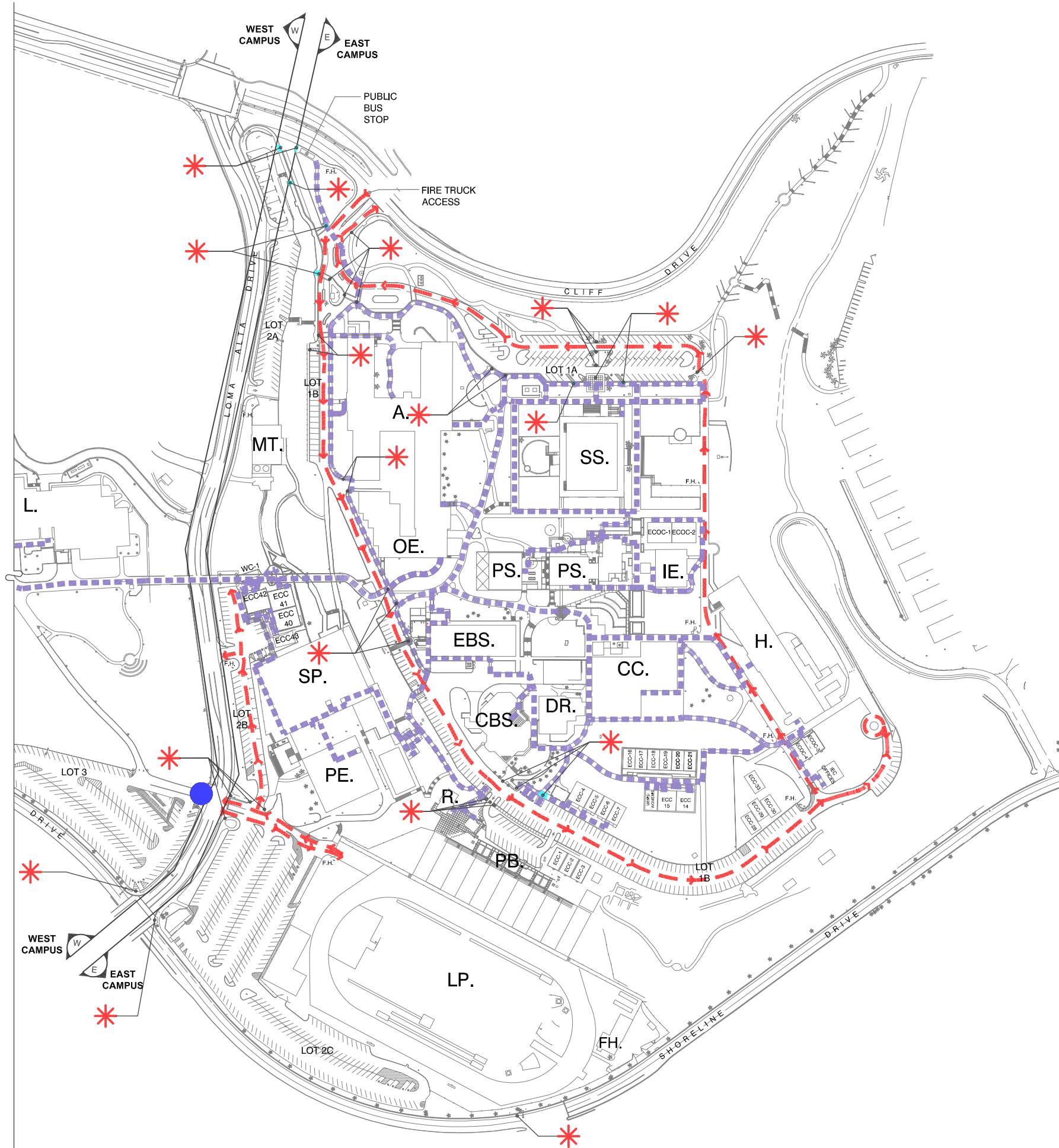

## EAST CAMPUS PLAN



**RJC Inc.**  
Design & Construction Management

PO Box 60202  
SANTA BARBARA  
CA 93160-0202

Fax: (805)-585-3310  
Tel: (805) 692-9477  
Tel: (562)-392-8001  
E-mail: admin@rjc-inc.com



Main Campus - East Campus  
Santa Barbara City College

721 CLIFF DRIVE  
SANTA BARBARA  
CA 93109-1673

**ADA PATH OF TRAVEL ASSESSMENT**  
**CURB RAMPS**

DATE: 2/19/16

**ME-4**



# LEGEND

 LONGITUDINAL SLOPE EXCEEDS 5% ALONG THE PATH OF TRAVEL

 FIRE LANE

 ADA PATH OF TRAVEL

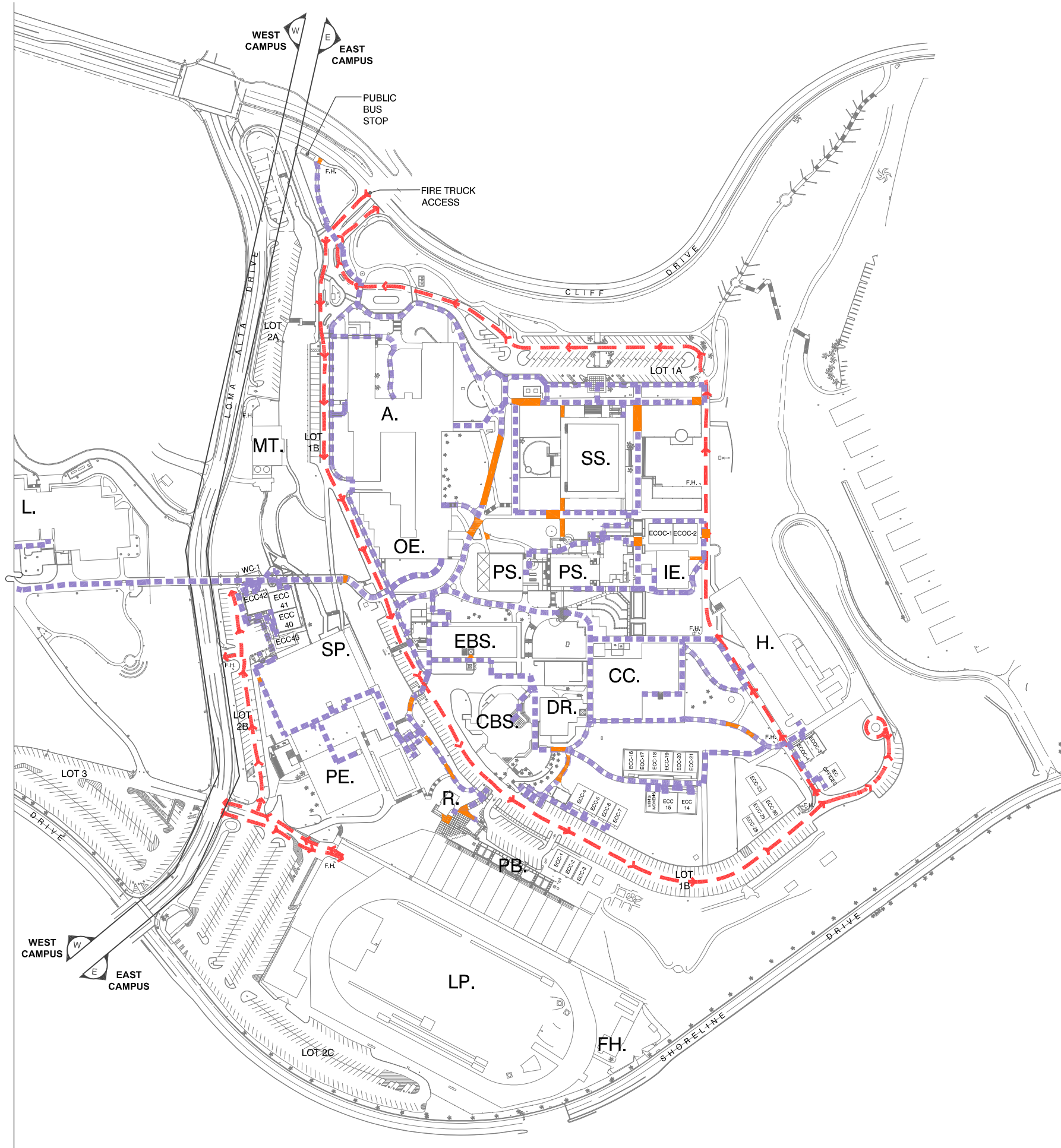

## EAST CAMPUS PLAN

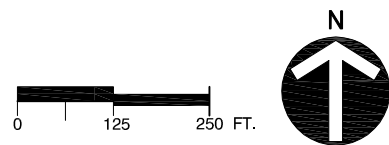

**RJC Inc.**  
Design & Construction Management

PO Box 60202  
SANTA BARBARA  
CA 93160-0202

Fax: (805)-585-3310  
Tel: (805) 692-9477  
Tel: (562)-392-8001  
E-mail: admin@rjc-inc.com



Main Campus - East Campus  
Santa Barbara City College

721 CLIFF DRIVE  
SANTA BARBARA  
CA 93109-1673

**ADA PATH OF TRAVEL ASSESSMENT**  
**LONGITUDINAL SLOPES ALONG THE PATH OF TRAVEL**

DATE: 2/19/16

**ME-5**

# LEGEND

- T** UNCLEAR PATH OF TRAVEL  
(E.G. SEPARATION OF PEDESTRIAN PATH VS. VEHICULAR PATH IS UNCLEAR)
- S** NON-COMPLIANT PATH OF TRAVEL SIGNAGE
- S** PATH OF TRAVEL SIGNAGE MISSING
- ⊖** ROOM I.D. NON-COMPLIANT OR MISSING
- ⊖** DOOR THRESHOLD NON-COMPLIANT
- ⊖** DOOR CLEARANCE NON-COMPLIANT
- F** ENTRYWAY FLOOR SURFACE NON-COMPLIANT
- ←** FIRE LANE
- ADA PATH OF TRAVEL

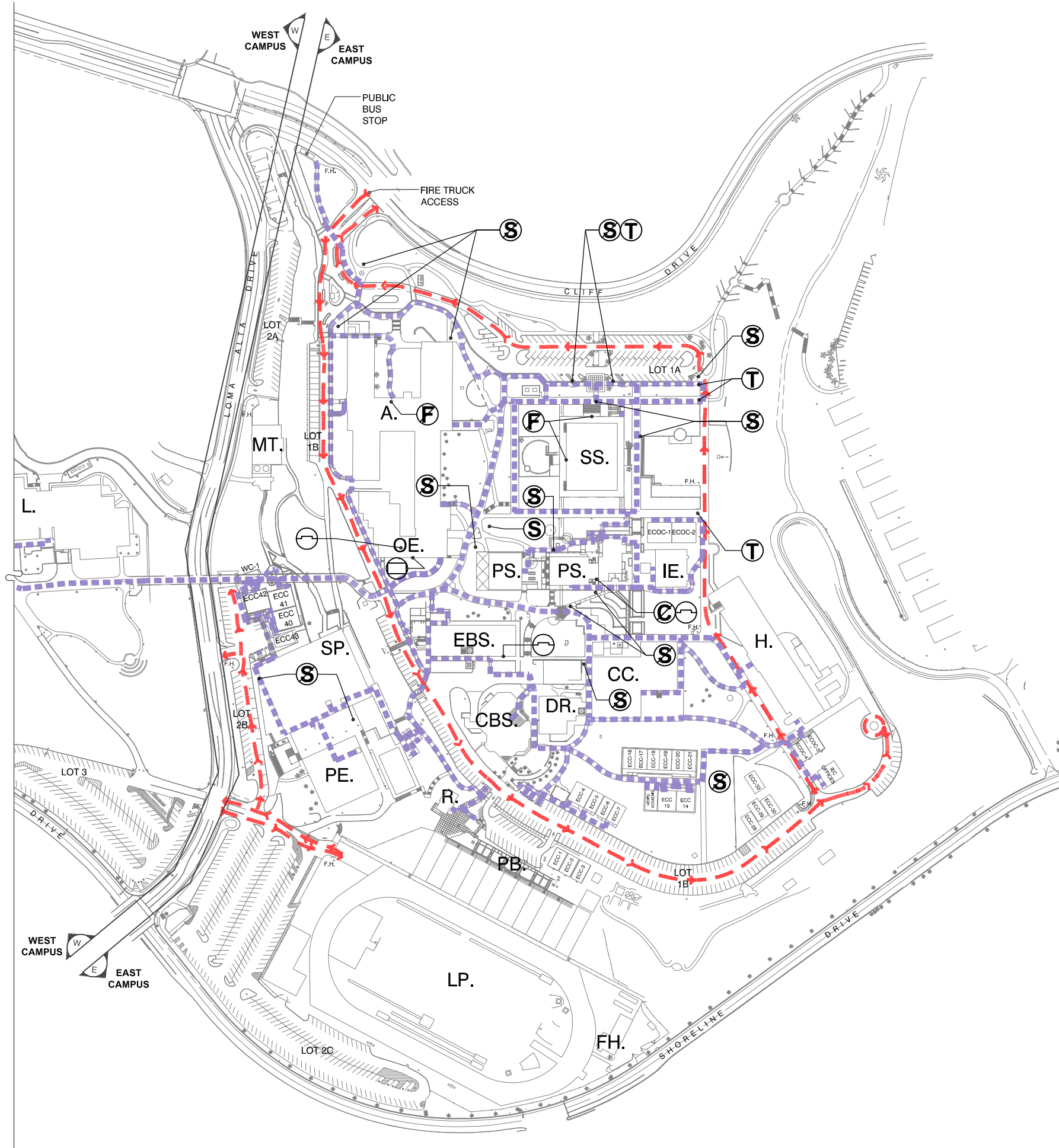

## EAST CAMPUS PLAN

SCALE:  
0 125 250 FT.



**RJC Inc.**  
Design & Construction Management

PO Box 60202  
SANTA BARBARA  
CA 93160-0202

Fax: (805)-585-3310  
Tel: (805) 692-9477  
Tel: (562)-392-8001  
E-mail: admin@rjc-inc.com



Main Campus - East Campus  
Santa Barbara City College

721 CLIFF DRIVE  
SANTA BARBARA  
CA 93109-1673

**ADA PATH OF TRAVEL ASSESSMENT**  
**PATH OF TRAVEL**

DATE: 2/19/16

**ME-6**

# LEGEND

**D** NO DETECTABLE WARNING AT FLUSH PEDESTRIAN/VEHICULAR INFLUENCE

 ABRUPT CHANGE IN LEVEL OR HAZARDOUS SURFACE FEATURE (E.G. GRATE)

 FIRE LANE

 ADA PATH OF TRAVEL

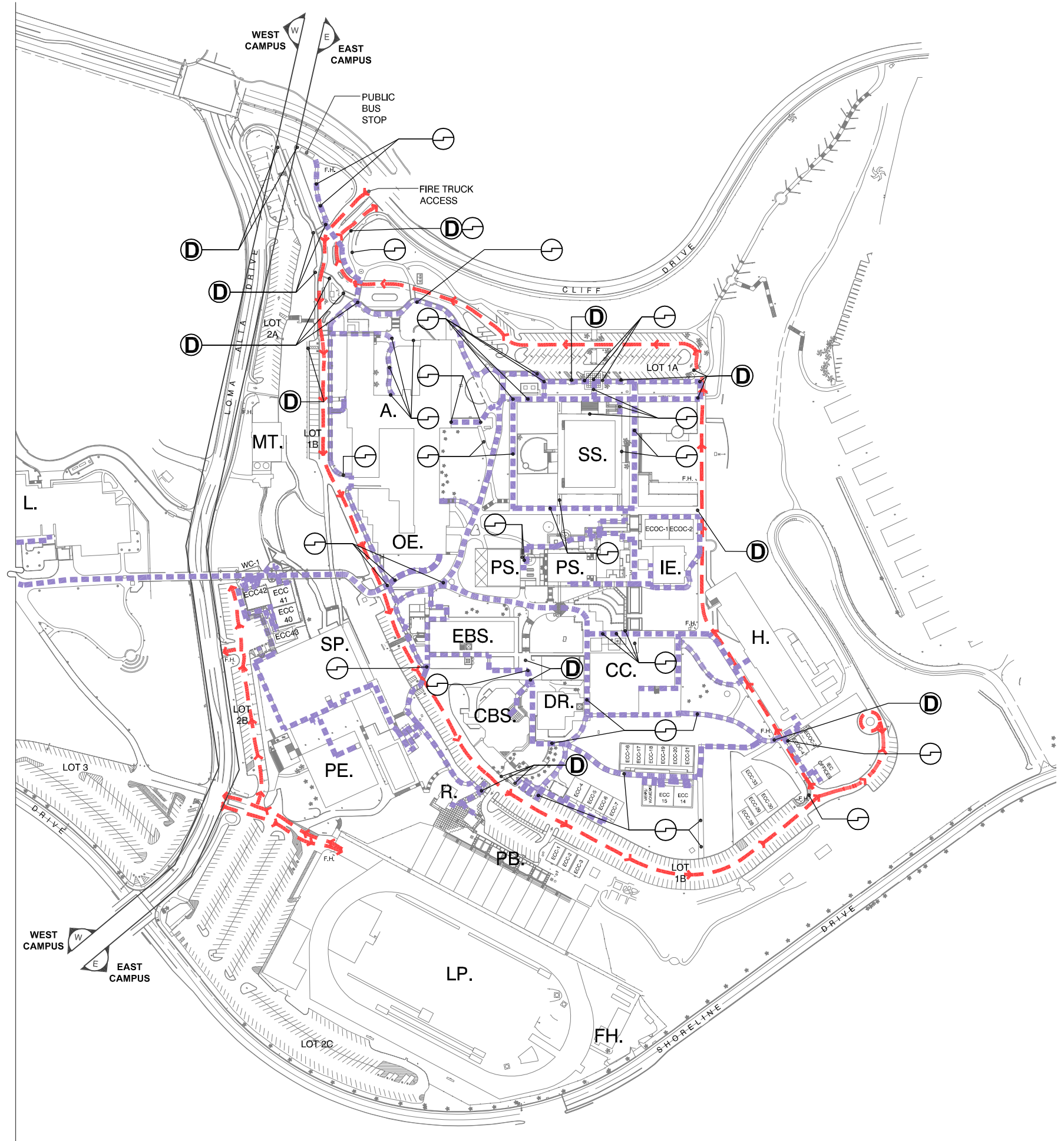

## EAST CAMPUS PLAN

SCALE:  
0 125 250 FT.



**RJC Inc.**  
Design & Construction Management

PO Box 60202  
SANTA BARBARA  
CA 93160-0202

Fax: (805)-585-3310  
Tel: (805) 692-9477  
Tel: (562)-392-8001  
E-mail: admin@rjc-inc.com



Main Campus - East Campus  
Santa Barbara City College











721 CLIFF DRIVE  
SANTA BARBARA  
CA 93109-1673

**ADA PATH OF TRAVEL ASSESSMENT  
POTENTIAL HAZARDOUS FEATURES**

DATE: 2/19/16

**ME-7**

# LEGEND

-  LONGITUDINAL SLOPE EXCEEDS 8.3% ON RAMPS
-  CROSS SLOPE EXCEEDS 2% ON RAMPS
-  INSUFFICIENT LANDING (SLOPE EXCEEDS 2%)
-  NO VISUAL WARNING OR FADED WARNING ON STAIRS
-  INCORRECT HANDRAIL RETURNS
-  INCORRECT HANDRAIL HEIGHTS
-  HANDRAIL NOT PROVIDED OR MISSING ON ONE SIDE OF RAMP OR STAIR
-  STAIR TREADS OR HEIGHTS NON-COMPLIANT
-  FIRE LANE
-  ADA PATH OF TRAVEL

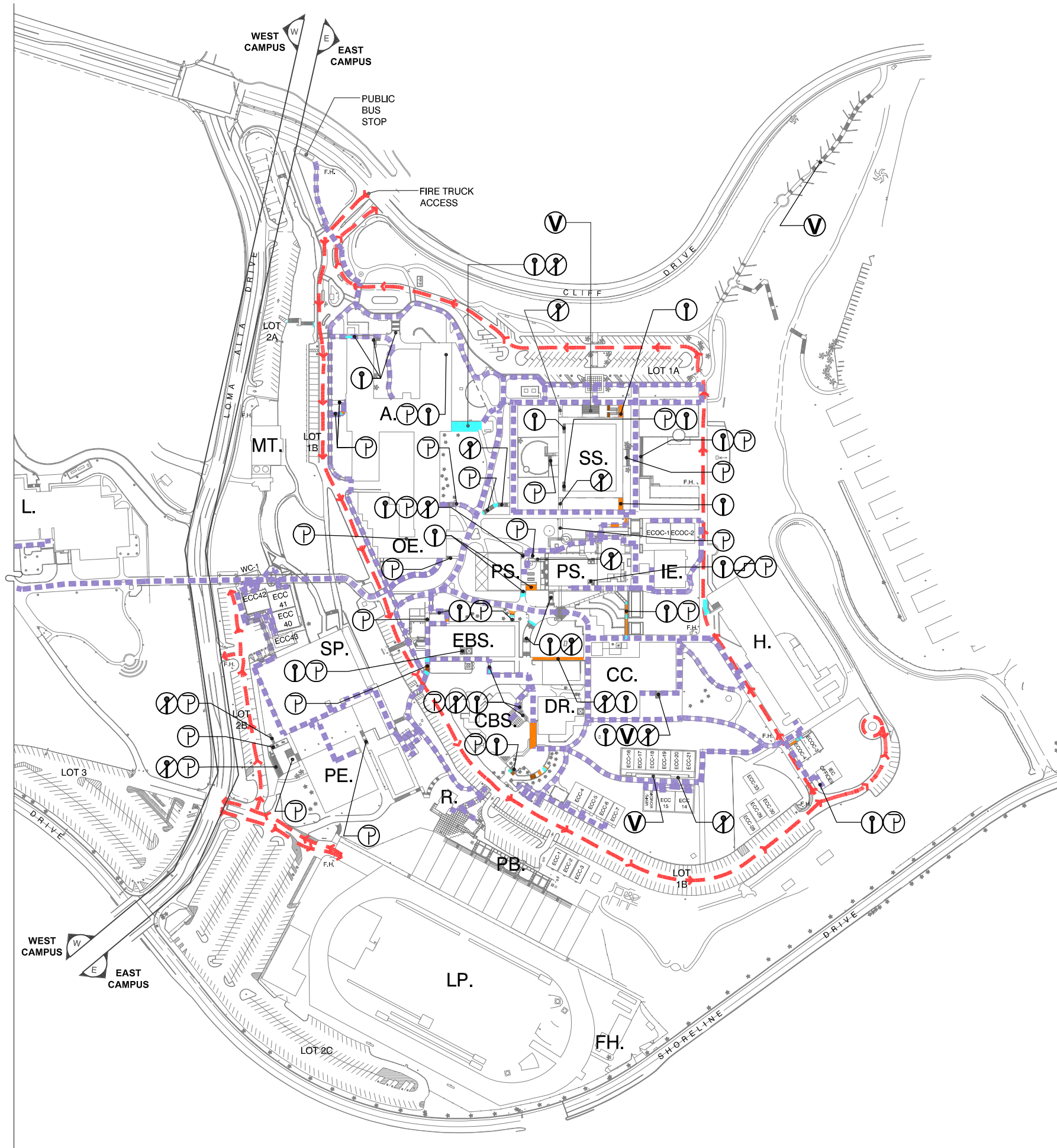

## EAST CAMPUS PLAN

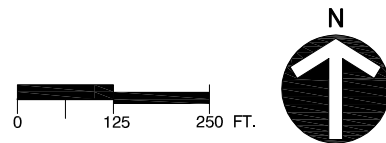

**RJC Inc.**  
Design & Construction Management

PO Box 60202  
SANTA BARBARA  
CA 93160-0202

Fax: (805)-585-3310  
Tel: (805) 692-9477  
Tel: (562)-392-8001  
E-mail: admin@rjc-inc.com



Main Campus - East Campus  
Santa Barbara City College

























721 CLIFF DRIVE  
SANTA BARBARA  
CA 93109-1673

**ADA PATH OF TRAVEL ASSESSMENT**  
**RAMPS AND STAIRS**

DATE: 2/19/16

**ME-8**

# LEGEND

-  EXISTING PEDESTRIAN BRIDGE
-  EXISTING FACILITIES
-  PARKING AREAS
-  LONGITUDINAL SLOPE EXCEEDS 5% ALONG THE PATH OF TRAVEL OR 8.3% ON RAMPS
-  ADA PARKING SLOPES EXCEED 2%
-  CROSS SLOPE EXCEEDS 2% ALONG THE PATH OF TRAVEL OR ON RAMPS
-  INSUFFICIENT LANDING (SLOPE EXCEEDS 2%)
-  NO DETECTABLE WARNING AT FLUSH PEDESTRIAN/VEHICULAR INFLUENCE
-  NO VISUAL WARNING OR FADED WARNING ON STAIRS
-  INCORRECT HANDRAIL RETURNS
-  INCORRECT HANDRAIL HEIGHTS
-  HANDRAIL NOT PROVIDED OR MISSING ON ONE SIDE OF RAMP OR STAIR
-  ABRUPT CHANGE IN LEVEL OR HAZARDOUS SURFACE FEATURE (E.G. GRATE)
-  UNCLEAR PATH OF TRAVEL (E.G. SEPARATION OF PEDESTRIAN PATH VS. VEHICULAR PATH IS UNCLEAR)
-  NON-COMPLIANT PATH OF TRAVEL SIGNAGE
-  PATH OF TRAVEL SIGNAGE MISSING
-  ROOM I.D. NON-COMPLIANT OR MISSING
-  DOOR THRESHOLD NON-COMPLIANT
-  DOOR CLEARANCE NON-COMPLIANT
-  ENTRYWAY FLOOR SURFACE NON-COMPLIANT
-  STAIR TREADS OR HEIGHTS NON-COMPLIANT
-  NONCOMPLIANT CURB RAMP
-  NO CURB RAMP OR REQUIRED RAMP MISSING
-  FIRE LANE
-  ADA PATH OF TRAVEL

## EAST CAMPUS PLAN

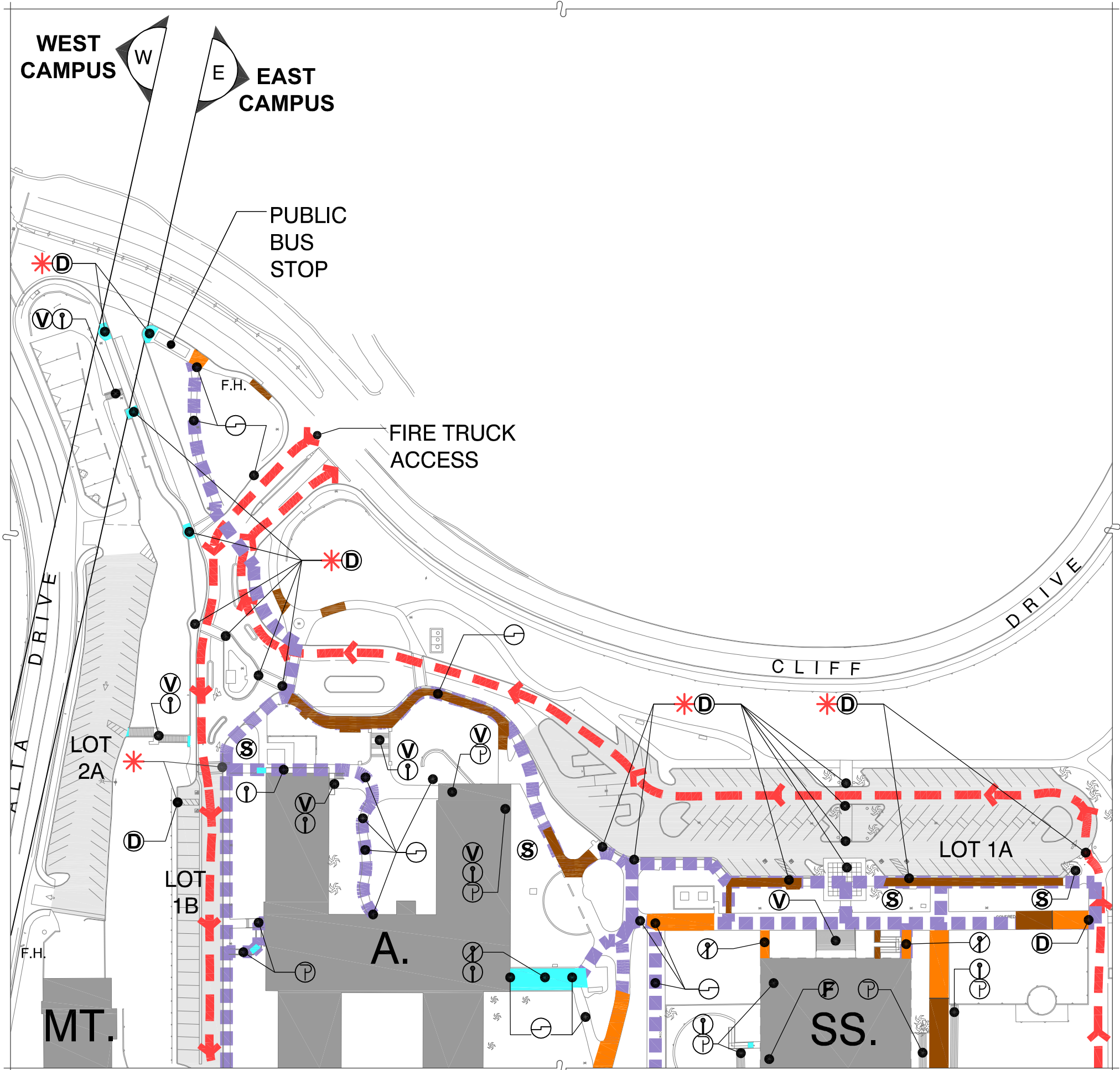
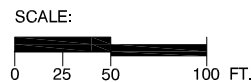

**RJC Inc.**  
Design & Construction Management

PO Box 60202  
SANTA BARBARA  
CA 93160-0202

Fax: (805)-585-3310  
Tel: (805) 692-9477  
Tel: (562)-392-8001  
E-mail: admin@rjc-inc.com



Main Campus - East Campus  
Santa Barbara City College

























721 CLIFF DRIVE  
SANTA BARBARA  
CA 93109-1673

**ADA PATH OF TRAVEL ASSESSMENT  
OVERALL**

DATE: 2/19/16

**ME-9.1**

# LEGEND

-  EXISTING PEDESTRIAN BRIDGE
-  EXISTING FACILITIES
-  PARKING AREAS
-  LONGITUDINAL SLOPE EXCEEDS 5% ALONG THE PATH OF TRAVEL OR 8.3% ON RAMPS
-  ADA PARKING SLOPES EXCEED 2%
-  CROSS SLOPE EXCEEDS 2% ALONG THE PATH OF TRAVEL OR ON RAMPS
-  INSUFFICIENT LANDING (SLOPE EXCEEDS 2%)
-  NO DETECTABLE WARNING AT FLUSH PEDESTRIAN/VEHICULAR INFLUENCE
-  NO VISUAL WARNING OR FADED WARNING ON STAIRS
-  INCORRECT HANDRAIL RETURNS
-  INCORRECT HANDRAIL HEIGHTS
-  HANDRAIL NOT PROVIDED OR MISSING ON ONE SIDE OF RAMP OR STAIR
-  ABRUPT CHANGE IN LEVEL OR HAZARDOUS SURFACE FEATURE (E.G. GRATE)
-  UNCLEAR PATH OF TRAVEL (E.G. SEPARATION OF PEDESTRIAN PATH VS. VEHICULAR PATH IS UNCLEAR)
-  NON-COMPLIANT PATH OF TRAVEL SIGNAGE
-  PATH OF TRAVEL SIGNAGE MISSING
-  ROOM I.D. NON-COMPLIANT OR MISSING
-  DOOR THRESHOLD NON-COMPLIANT
-  DOOR CLEARANCE NON-COMPLIANT
-  ENTRYWAY FLOOR SURFACE NON-COMPLIANT
-  STAIR TREADS OR HEIGHTS NON-COMPLIANT
-  NONCOMPLIANT CURB RAMP
-  NO CURB RAMP OR REQUIRED RAMP MISSING
-  FIRE LANE
-  ADA PATH OF TRAVEL

## EAST CAMPUS PLAN

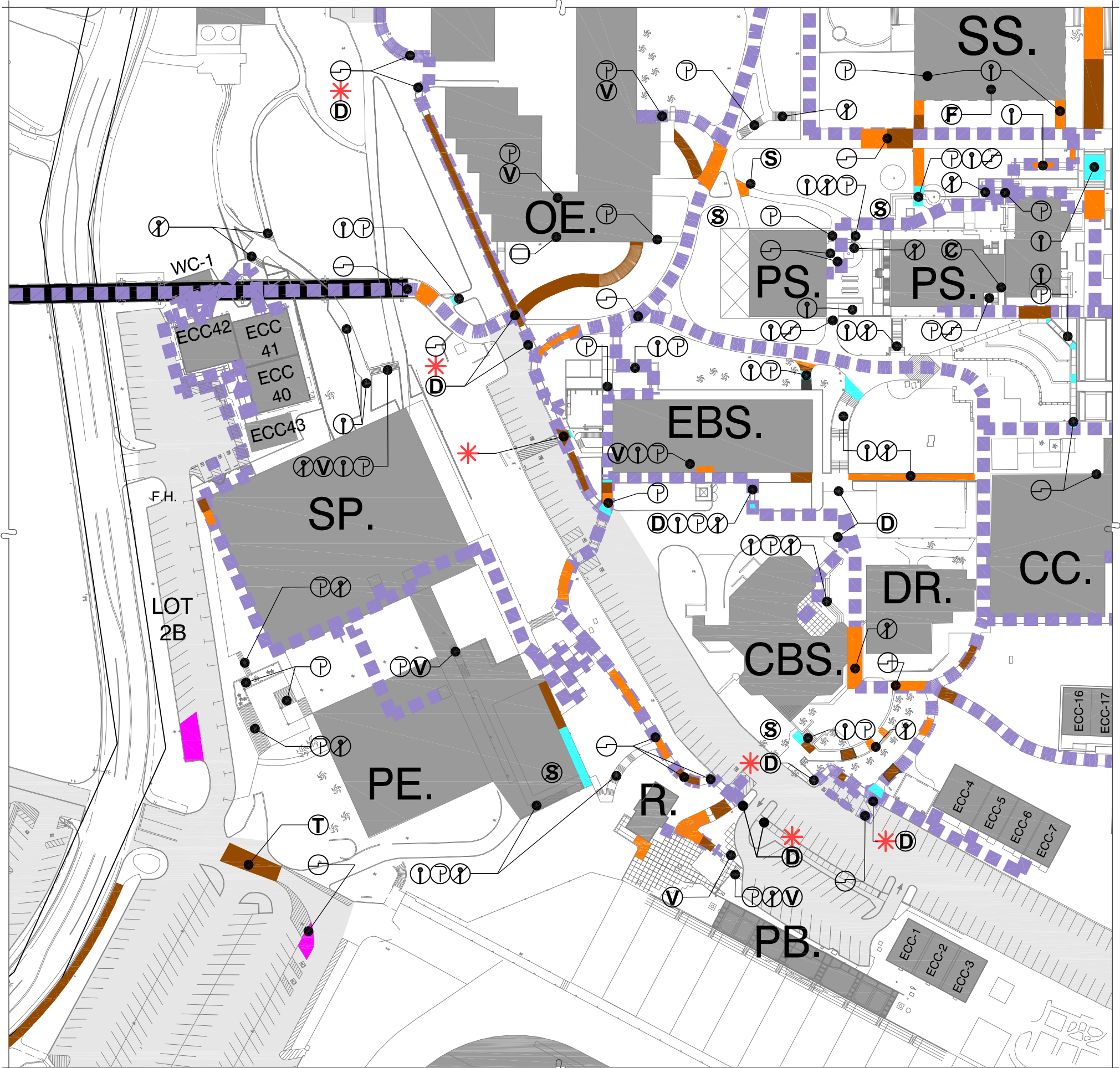
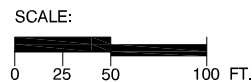

**RJC Inc.**  
Design & Construction Management

PO Box 60202  
SANTA BARBARA  
CA 93160-0202

Fax: (805)-585-3310  
Tel: (805) 692-9477  
Tel: (562)-392-8001  
E-mail: admin@rjc-inc.com



Main Campus - East Campus  
Santa Barbara City College

























721 CLIFF DRIVE  
SANTA BARBARA  
CA 93109-1673

**ADA PATH OF TRAVEL ASSESSMENT**  
**OVERALL**

DATE: 2/19/16

**ME-9.2**

# LEGEND

-  EXISTING PEDESTRIAN BRIDGE
-  EXISTING FACILITIES
-  PARKING AREAS
-  LONGITUDINAL SLOPE EXCEEDS 5% ALONG THE PATH OF TRAVEL OR 8.3% ON RAMPS
-  ADA PARKING SLOPES EXCEED 2%
-  CROSS SLOPE EXCEEDS 2% ALONG THE PATH OF TRAVEL OR ON RAMPS
-  INSUFFICIENT LANDING (SLOPE EXCEEDS 2%)
-  NO DETECTABLE WARNING AT FLUSH PEDESTRIAN/VEHICULAR INFLUENCE
-  NO VISUAL WARNING OR FADED WARNING ON STAIRS
-  INCORRECT HANDRAIL RETURNS
-  INCORRECT HANDRAIL HEIGHTS
-  HANDRAIL NOT PROVIDED OR MISSING ON ONE SIDE OF RAMP OR STAIR
-  ABRUPT CHANGE IN LEVEL OR HAZARDOUS SURFACE FEATURE (E.G. GRATE)
-  UNCLEAR PATH OF TRAVEL (E.G. SEPARATION OF PEDESTRIAN PATH VS. VEHICULAR PATH IS UNCLEAR)
-  NON-COMPLIANT PATH OF TRAVEL SIGNAGE
-  PATH OF TRAVEL SIGNAGE MISSING
-  ROOM I.D. NON-COMPLIANT OR MISSING
-  DOOR THRESHOLD NON-COMPLIANT
-  DOOR CLEARANCE NON-COMPLIANT
-  ENTRYWAY FLOOR SURFACE NON-COMPLIANT
-  STAIR TREADS OR HEIGHTS NON-COMPLIANT
-  NONCOMPLIANT CURB RAMP
-  NO CURB RAMP OR REQUIRED RAMP MISSING
-  FIRE LANE
-  ADA PATH OF TRAVEL

## EAST CAMPUS PLAN

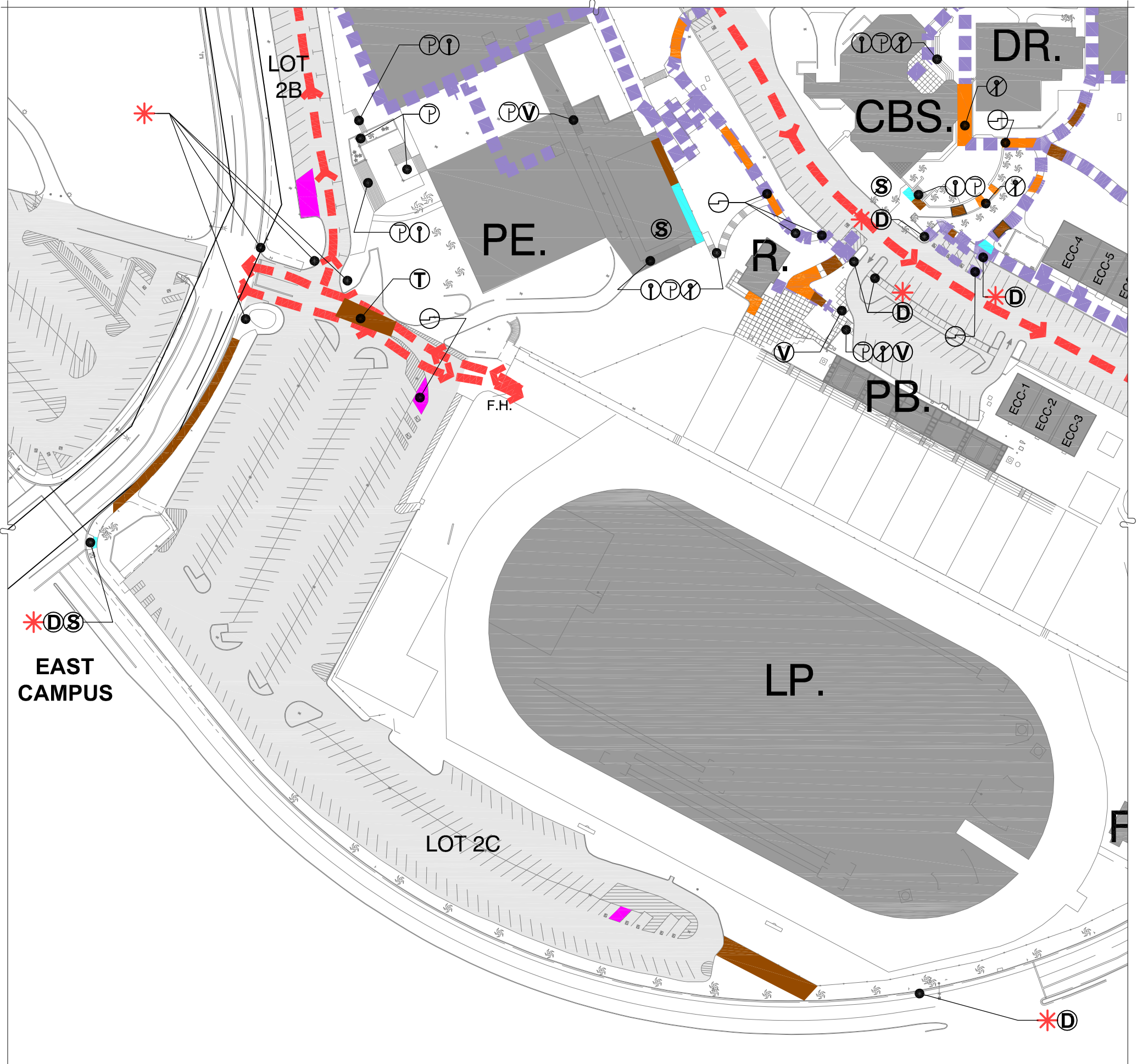
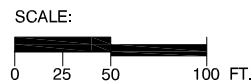

**RJC Inc.**  
Design & Construction Management

PO Box 60202  
SANTA BARBARA  
CA 93160-0202

Fax: (805)-585-3310  
Tel: (805) 692-9477  
Tel: (562)-392-8001  
E-mail: admin@rjc-inc.com



Main Campus - East Campus  
Santa Barbara City College

























721 CLIFF DRIVE  
SANTA BARBARA  
CA 93109-1673

**ADA PATH OF TRAVEL ASSESSMENT  
OVERALL**

DATE: 2/19/16

**ME-9.3**

# LEGEND

-  EXISTING PEDESTRIAN BRIDGE
-  EXISTING FACILITIES
-  PARKING AREAS
-  LONGITUDINAL SLOPE EXCEEDS 5% ALONG THE PATH OF TRAVEL OR 8.3% ON RAMPS
-  ADA PARKING SLOPES EXCEED 2%
-  CROSS SLOPE EXCEEDS 2% ALONG THE PATH OF TRAVEL OR ON RAMPS
-  INSUFFICIENT LANDING (SLOPE EXCEEDS 2%)
-  NO DETECTABLE WARNING AT FLUSH PEDESTRIAN/VEHICULAR INFLUENCE
-  NO VISUAL WARNING OR FADED WARNING ON STAIRS
-  INCORRECT HANDRAIL RETURNS
-  INCORRECT HANDRAIL HEIGHTS
-  HANDRAIL NOT PROVIDED OR MISSING ON ONE SIDE OF RAMP OR STAIR
-  ABRUPT CHANGE IN LEVEL OR HAZARDOUS SURFACE FEATURE (E.G. GRATE)
-  UNCLEAR PATH OF TRAVEL (E.G. SEPARATION OF PEDESTRIAN PATH VS. VEHICULAR PATH IS UNCLEAR)
-  NON-COMPLIANT PATH OF TRAVEL SIGNAGE
-  PATH OF TRAVEL SIGNAGE MISSING
-  ROOM I.D. NON-COMPLIANT OR MISSING
-  DOOR THRESHOLD NON-COMPLIANT
-  DOOR CLEARANCE NON-COMPLIANT
-  ENTRYWAY FLOOR SURFACE NON-COMPLIANT
-  STAIR TREADS OR HEIGHTS NON-COMPLIANT
-  NONCOMPLIANT CURB RAMP
-  NO CURB RAMP OR REQUIRED RAMP MISSING
-  FIRE LANE
-  ADA PATH OF TRAVEL

## EAST CAMPUS PLAN

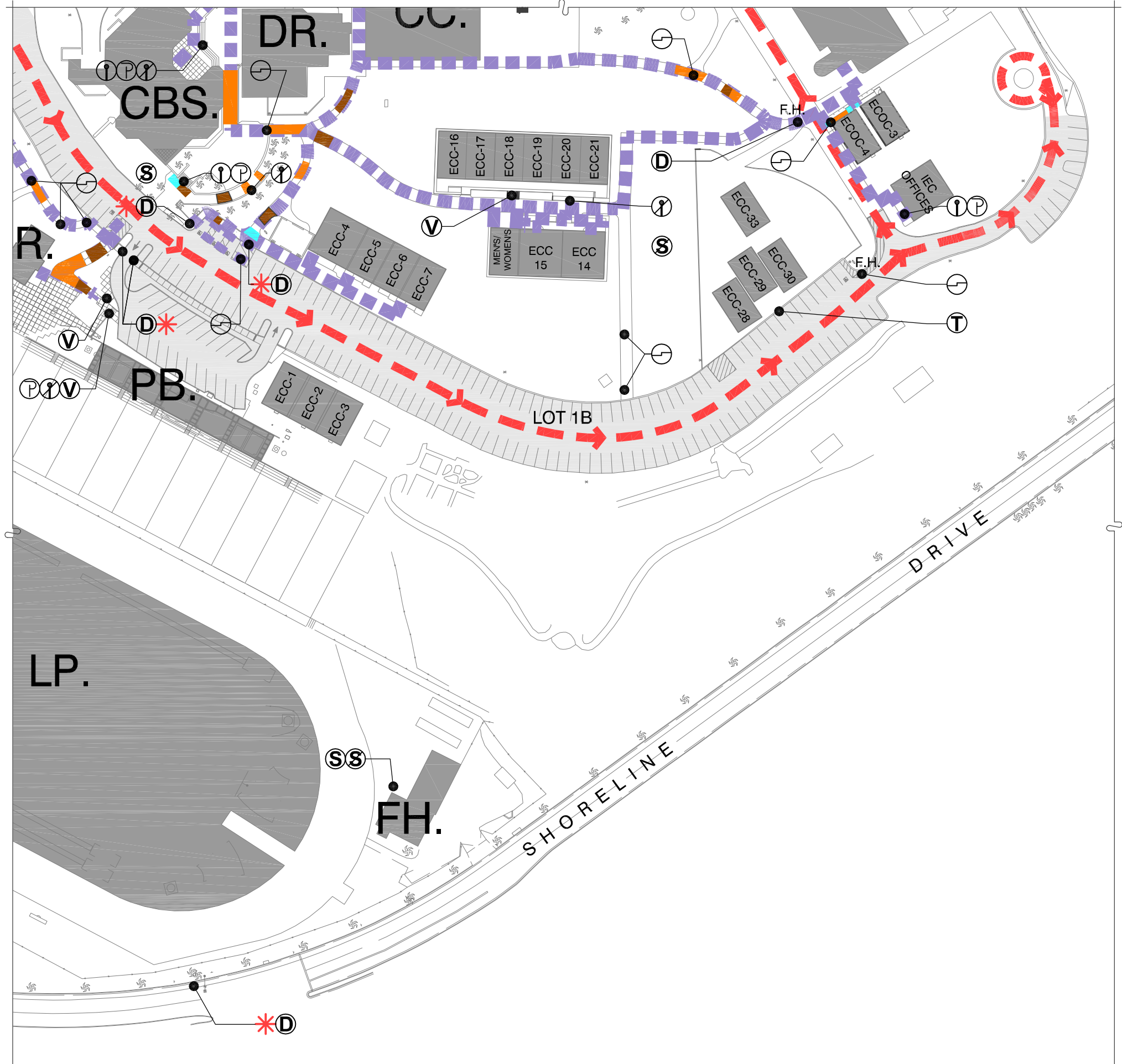
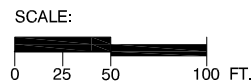

**RJC Inc.**  
Design & Construction Management

PO Box 60202  
SANTA BARBARA  
CA 93160-0202

Fax: (805)-585-3310  
Tel: (805) 692-9477  
Tel: (562)-392-8001  
E-mail: admin@rjc-inc.com



Main Campus - East Campus  
Santa Barbara City College

721 CLIFF DRIVE  
SANTA BARBARA  
CA 93109-1673

























**ADA PATH OF TRAVEL ASSESSMENT**  
**OVERALL**

DATE: 2/19/16

**ME-9.4**









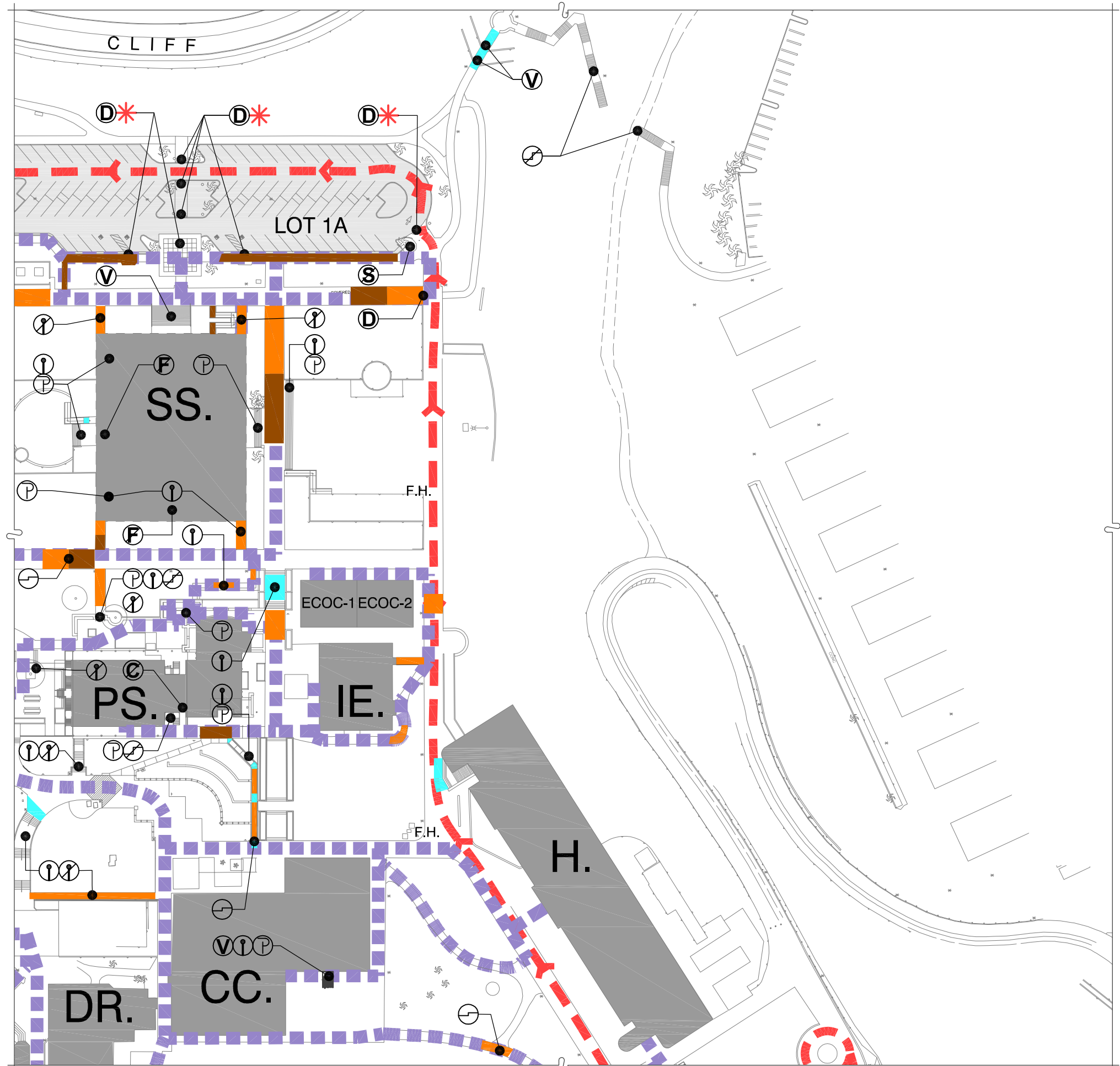
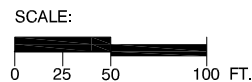

















# LEGEND

-  EXISTING PEDESTRIAN BRIDGE
-  EXISTING FACILITIES
-  PARKING AREAS
-  LONGITUDINAL SLOPE EXCEEDS 5% ALONG THE PATH OF TRAVEL OR 8.3% ON RAMPS
-  ADA PARKING SLOPES EXCEED 2%
-  CROSS SLOPE EXCEEDS 2% ALONG THE PATH OF TRAVEL OR ON RAMPS
-  INSUFFICIENT LANDING (SLOPE EXCEEDS 2%)
-  NO DETECTABLE WARNING AT FLUSH PEDESTRIAN/VEHICULAR INFLUENCE
-  NO VISUAL WARNING OR FADED WARNING ON STAIRS
-  INCORRECT HANDRAIL RETURNS
-  INCORRECT HANDRAIL HEIGHTS
-  HANDRAIL NOT PROVIDED OR MISSING ON ONE SIDE OF RAMP OR STAIR
-  ABRUPT CHANGE IN LEVEL OR HAZARDOUS SURFACE FEATURE (E.G. GRATE)
-  UNCLEAR PATH OF TRAVEL (E.G. SEPARATION OF PEDESTRIAN PATH VS. VEHICULAR PATH IS UNCLEAR)
-  NON-COMPLIANT PATH OF TRAVEL SIGNAGE
-  PATH OF TRAVEL SIGNAGE MISSING
-  ROOM I.D. NON-COMPLIANT OR MISSING
-  DOOR THRESHOLD NON-COMPLIANT
-  DOOR CLEARANCE NON-COMPLIANT
-  ENTRYWAY FLOOR SURFACE NON-COMPLIANT
-  STAIR TREADS OR HEIGHTS NON-COMPLIANT
-  NONCOMPLIANT CURB RAMP
-  NO CURB RAMP OR REQUIRED RAMP MISSING
-  FIRE LANE
-  ADA PATH OF TRAVEL

## EAST CAMPUS PLAN





# LEGEND

-  EXISTING PEDESTRIAN BRIDGE
-  EXISTING FACILITIES
-  PARKING AREAS
-  LONGITUDINAL SLOPE EXCEEDS 5% ALONG THE PATH OF TRAVEL OR 8.3% ON RAMPS
-  ADA PARKING SLOPES EXCEED 2%
-  CROSS SLOPE EXCEEDS 2% ALONG THE PATH OF TRAVEL OR ON RAMPS
-  INSUFFICIENT LANDING (SLOPE EXCEEDS 2%)
-  NO DETECTABLE WARNING AT FLUSH PEDESTRIAN/VEHICULAR INFLUENCE
-  NO VISUAL WARNING OR FADED WARNING ON STAIRS
-  INCORRECT HANDRAIL RETURNS
-  INCORRECT HANDRAIL HEIGHTS
-  HANDRAIL NOT PROVIDED OR MISSING ON ONE SIDE OF RAMP OR STAIR
-  ABRUPT CHANGE IN LEVEL OR HAZARDOUS SURFACE FEATURE (E.G. GRATE)
-  UNCLEAR PATH OF TRAVEL (E.G. SEPARATION OF PEDESTRIAN PATH VS. VEHICULAR PATH IS UNCLEAR)
-  NON-COMPLIANT PATH OF TRAVEL SIGNAGE
-  PATH OF TRAVEL SIGNAGE MISSING
-  ROOM I.D. NON-COMPLIANT OR MISSING
-  DOOR THRESHOLD NON-COMPLIANT
-  DOOR CLEARANCE NON-COMPLIANT
-  ENTRYWAY FLOOR SURFACE NON-COMPLIANT
-  STAIR TREADS OR HEIGHTS NON-COMPLIANT
-  NONCOMPLIANT CURB RAMP
-  NO CURB RAMP OR REQUIRED RAMP MISSING
-  FIRE LANE
-  ADA PATH OF TRAVEL

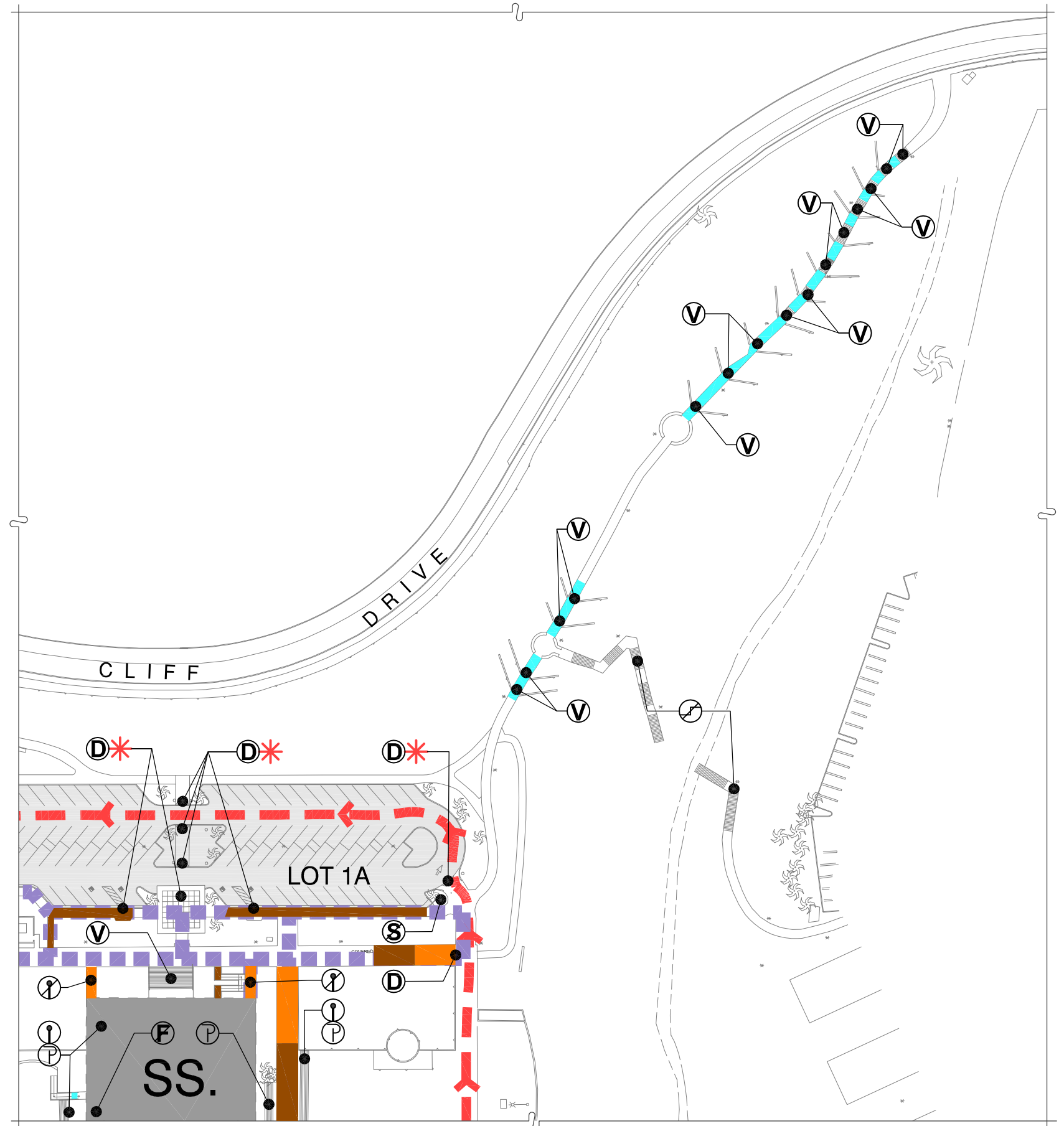
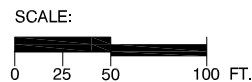
## EAST CAMPUS PLAN



# LEGEND

-  FIRE LANE
-  ADA PATH OF TRAVEL

## EVACUATION SITES

- I FROM ADMINISTRATION BLDG, AUTOQUAD AND MARINE TECHNOLOGY
- II FROM STUDENT SERVICE BLDG, ECOC 1 AND 2, FRC, PHYSICAL SCIENCE
- III FROM NORTH SIDE OF EBS BLDG, OE BLDG
- IV FROM SOUTH SIDE OF EBS BLDG, BOOKSTORE, CAMPUS CENTER FIRST FLOOR, KAPLAN ASPECT, ECC BUILDINGS
- V FROM STADIUM FIELD, PE BUILDING ECC 41-44, VERY IMPORTANT TO GET TO HIGHER GROUND IN CASE OF TSUNAMI BROUGHT ON BY AN EARTHQUAKE
- VI HUMANITIES BLDG, ECOC 3 AND 4, CAMPUS CENTER FIRST AND SECOND FLOOR, INTERNATIONAL OFFICE, ECC BLDGS, KAPLAN ASPECT
- VII ALL BUILDINGS WEST CAMPUS
- VIII MEMBERS OF PRESIDENTS CABINET IN THE EVENT THAT A110 IS NOT REACHABLE

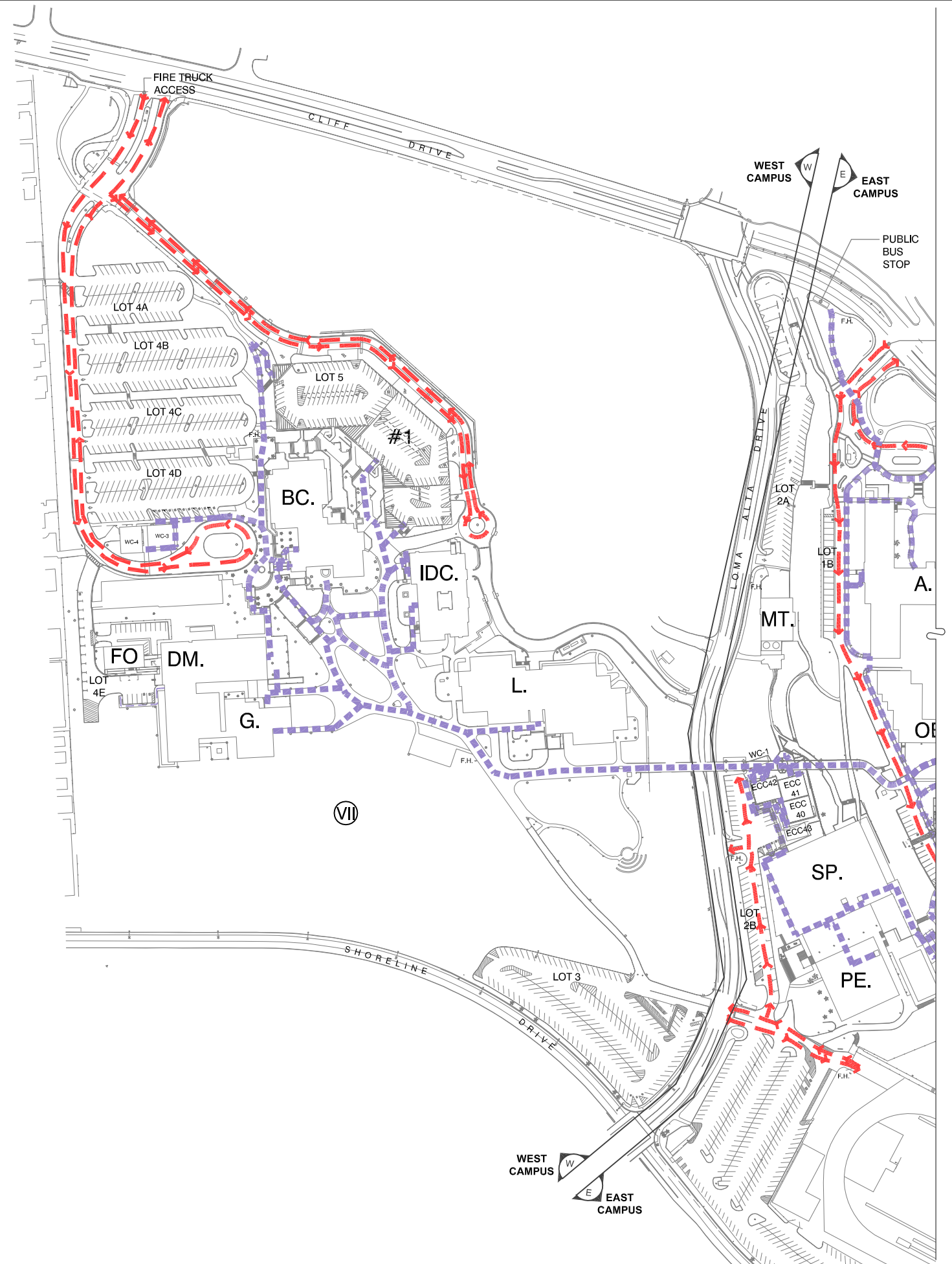

## WEST CAMPUS PLAN

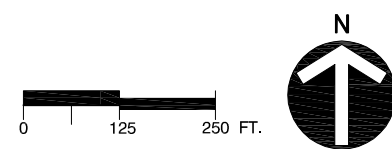

**RJC Inc.**  
Design & Construction Management

PO Box 60202  
SANTA BARBARA  
CA 93160-0202

Fax: (805)-585-3310  
Tel: (805) 692-9477  
Tel: (562)-392-8001  
E-mail: admin@rjc-inc.com







Main Campus - West Campus  
Santa Barbara City College

721 CLIFF DRIVE  
SANTA BARBARA  
CA 93109-1673

**ADA PATH OF TRAVEL ASSESSMENT  
EVACUATION SITES**

DATE: 2/19/16  
**MW-0**

# LEGEND

-  EXISTING PEDESTRIAN BRIDGE
-  EXISTING FACILITIES
-  PARKING AREAS
-  FIRE LANE
-  ADA PATH OF TRAVEL

LOT#:	PARKING SPACES	ACCESSIBLE SPACES (1 VAN SPACE MIN.)	TOTAL SPACES PROVIDED	TOTAL ACCESSIBLE SPACES PROVIDED	TOTAL ACCESSIBLE SPACES REQUIRED
1A	94	2+2 VAN=4	98	4	4 (MIN.)
1B	213	9+2 VAN=11	224	11	7 (MIN.)
2A	57	0+0 VAN=0	57	0	3 (MIN.)
2B	43	4+1 VAN=5	48	5	2 (MIN.)
2C	315	7+1 VAN=8	323	8	8 (MIN.)
3	161	5+0 VAN=5	166	5	6 (MIN.)
4A-4D	329	5+3 VAN=8	337	8	8 (MIN.)
4E	16	2+1 VAN=3	19	3	1 (MIN.)
5	372	8+1 VAN=9	381	9	8 (MIN.)

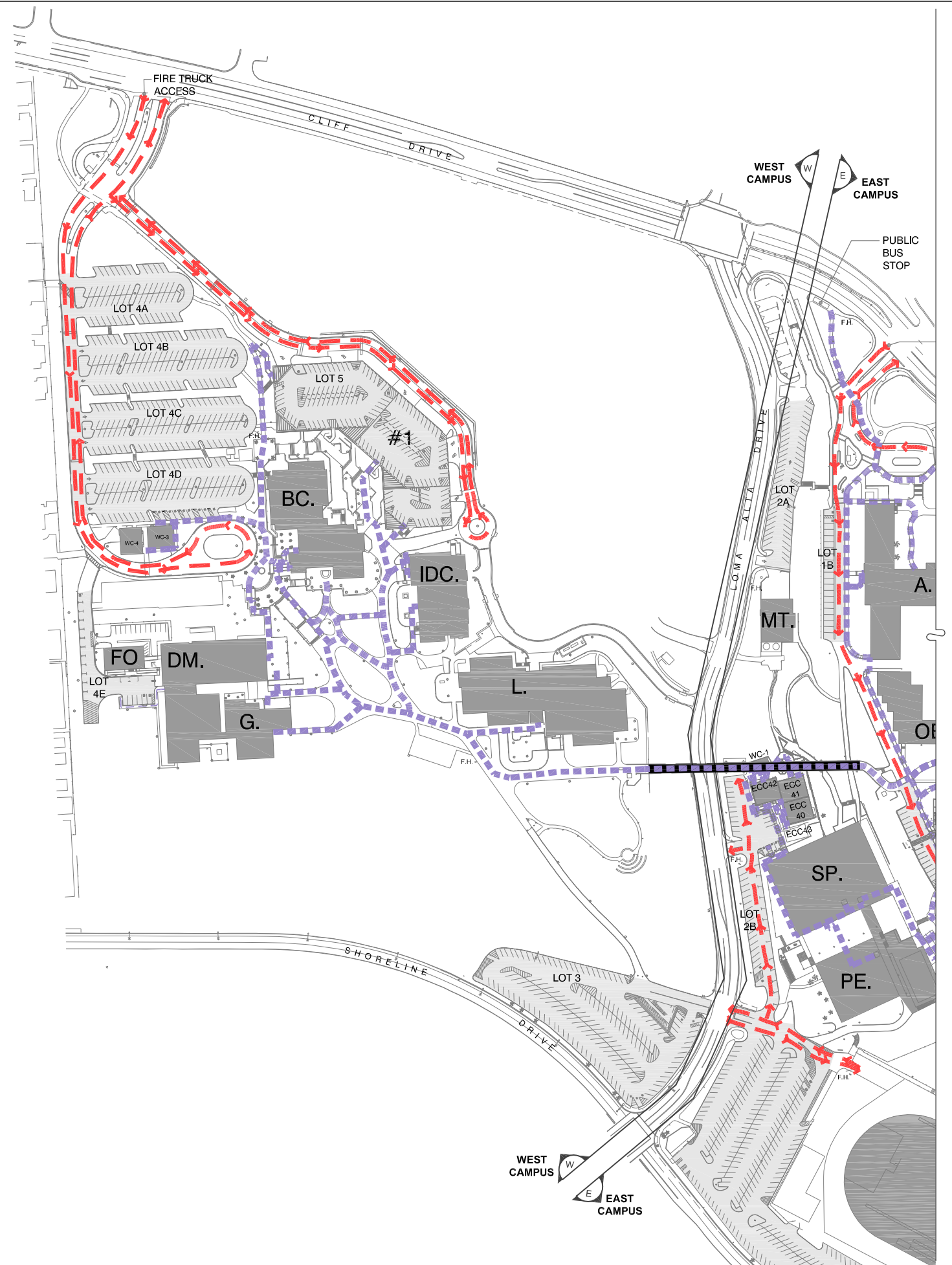

## WEST CAMPUS PLAN

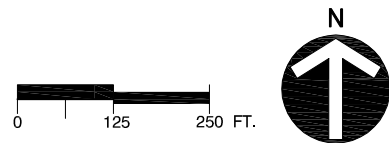

**RJC Inc.**  
Design & Construction Management

PO Box 60202  
SANTA BARBARA  
CA 93160-0202

Fax: (805)-585-3310  
Tel: (805) 692-9477  
Tel: (562)-392-8001  
E-mail: admin@rjc-inc.com



Main Campus - West Campus  
Santa Barbara City College

721 CLIFF DRIVE  
SANTA BARBARA  
CA 93109-1673

**ADA PATH OF TRAVEL ASSESSMENT**  
**EXISTING PARKING**

DATE: 2/19/16

**MW-1**

# LEGEND

- ADA PARKING SLOPES EXCEED 2%
- FIRE LANE
- ADA PATH OF TRAVEL

\*NOTE: ALL PARKING SLOPES ON THE WEST SIDE OF MAIN CAMPUS ARE COMPLIANT

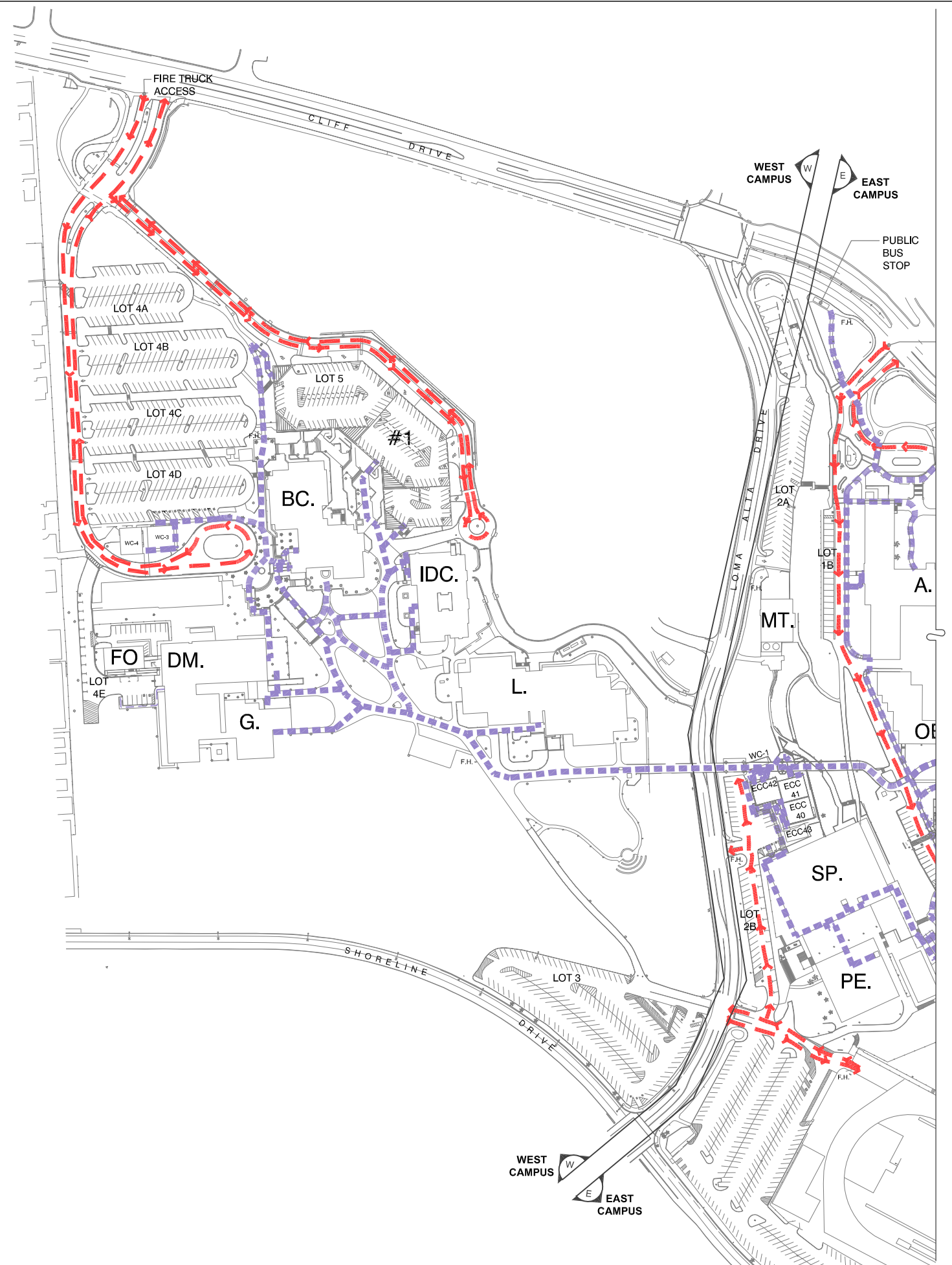

## WEST CAMPUS PLAN

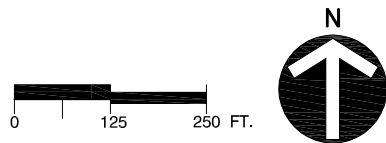

**RJC Inc.**  
Design & Construction Management

PO Box 60202  
SANTA BARBARA  
CA 93160-0202

Fax: (805)-585-3310  
Tel: (805) 692-9477  
Tel: (562)-392-8001  
E-mail: admin@rjc-inc.com



Main Campus - West Campus  
Santa Barbara City College

721 CLIFF DRIVE  
SANTA BARBARA  
CA 93109-1673

**ADA PATH OF TRAVEL ASSESSMENT**  
**ACCESSIBLE PARKING STALLS**

DATE: 2/19/16

**MW-2**

# LEGEND

 CROSS SLOPE EXCEEDS 2% ALONG THE PATH OF TRAVEL

 FIRE LANE

 ADA PATH OF TRAVEL

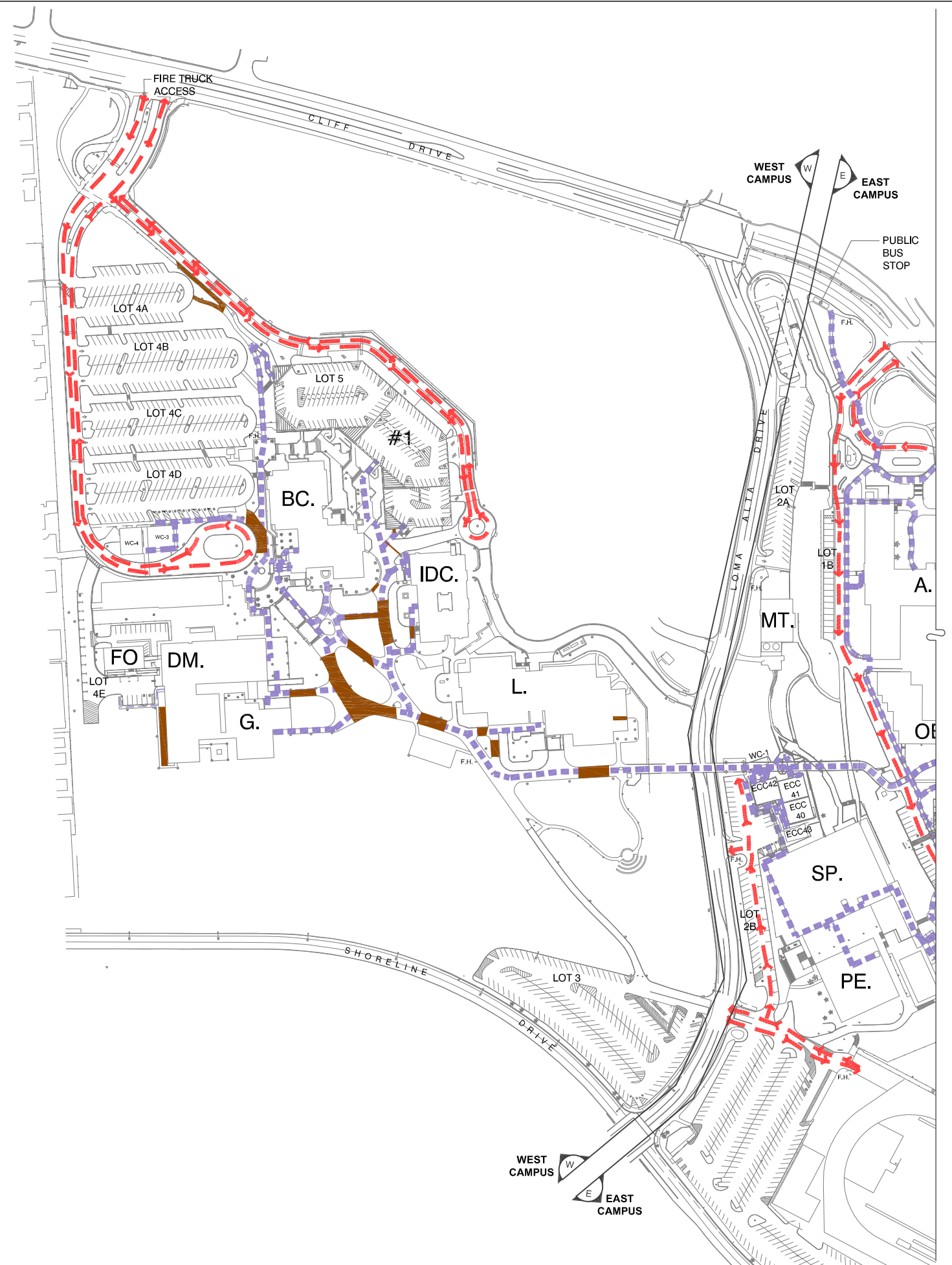

## WEST CAMPUS PLAN

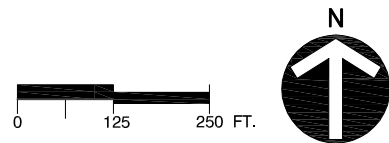

**RJC Inc.**  
Design & Construction Management

PO Box 60202  
SANTA BARBARA  
CA 93160-0202

Fax: (805)-585-3310  
Tel: (805) 692-9477  
Tel: (562)-392-8001  
E-mail: admin@rjc-inc.com



Main Campus - West Campus  
Santa Barbara City College





721 CLIFF DRIVE  
SANTA BARBARA  
CA 93109-1673

**ADA PATH OF TRAVEL ASSESSMENT**  
**CROSS SLOPES ALONG THE PATH OF TRAVEL**

DATE: 2/19/16

**MW-3**

# LEGEND

-  INSUFFICIENT LANDING (SLOPE EXCEEDS 2%)
-  NONCOMPLIANT CURB RAMP
-  NO CURB RAMP OR REQUIRED RAMP MISSING
-  FIRE LANE
-  ADA PATH OF TRAVEL

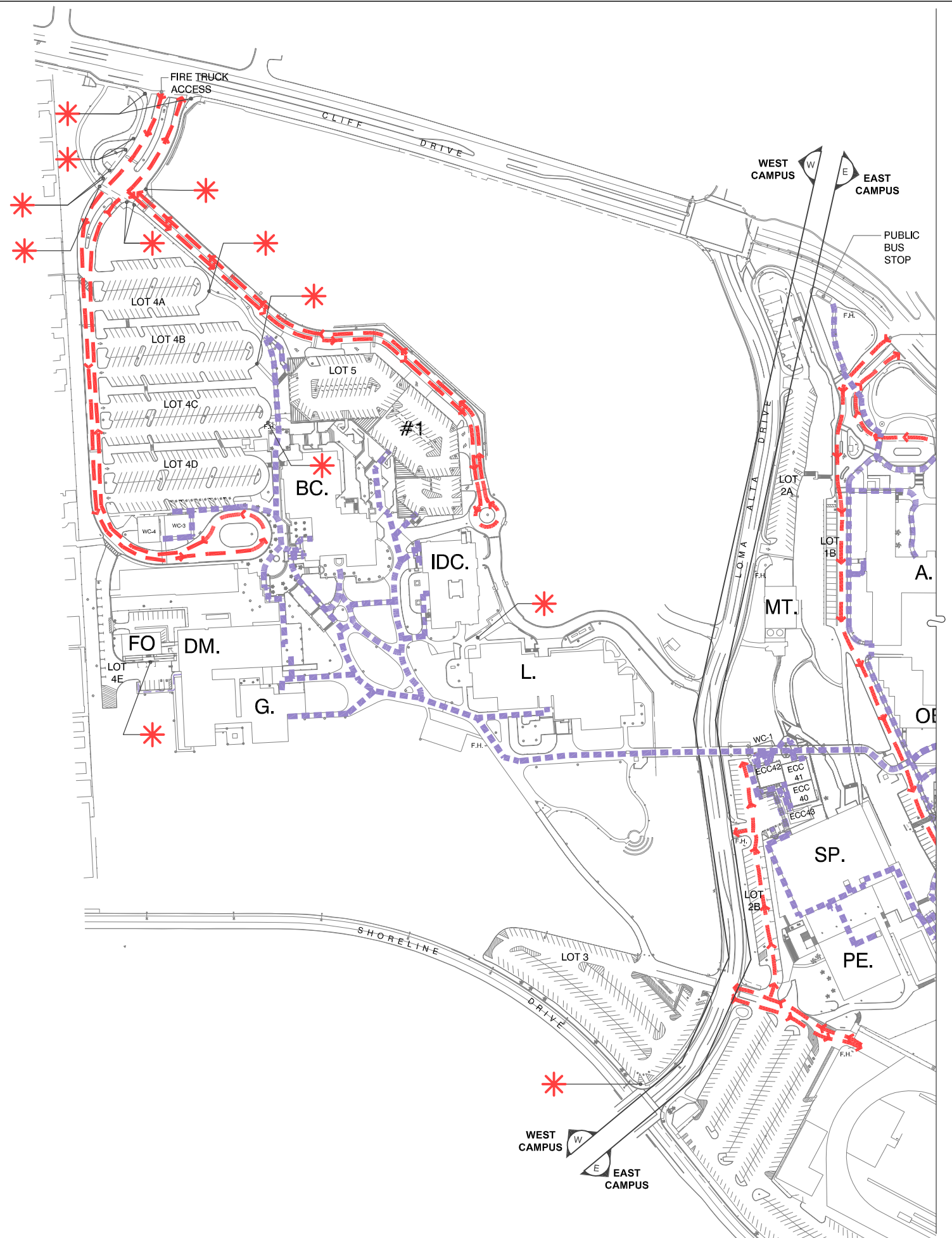

## WEST CAMPUS PLAN

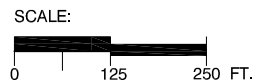

**RJC Inc.**  
Design & Construction Management

PO Box 60202  
SANTA BARBARA  
CA 93160-0202

Fax: (805)-585-3310  
Tel: (805) 692-9477  
Tel: (562)-392-8001  
E-mail: admin@rjc-inc.com



Main Campus - West Campus  
Santa Barbara City College

721 CLIFF DRIVE  
SANTA BARBARA  
CA 93109-1673

**ADA PATH OF TRAVEL ASSESSMENT**  
**CURB RAMPS**

DATE: 2/19/16

**MW-4**

# LEGEND

 LONGITUDINAL SLOPE EXCEEDS 5% ALONG THE PATH OF TRAVEL

 FIRE LANE

 ADA PATH OF TRAVEL

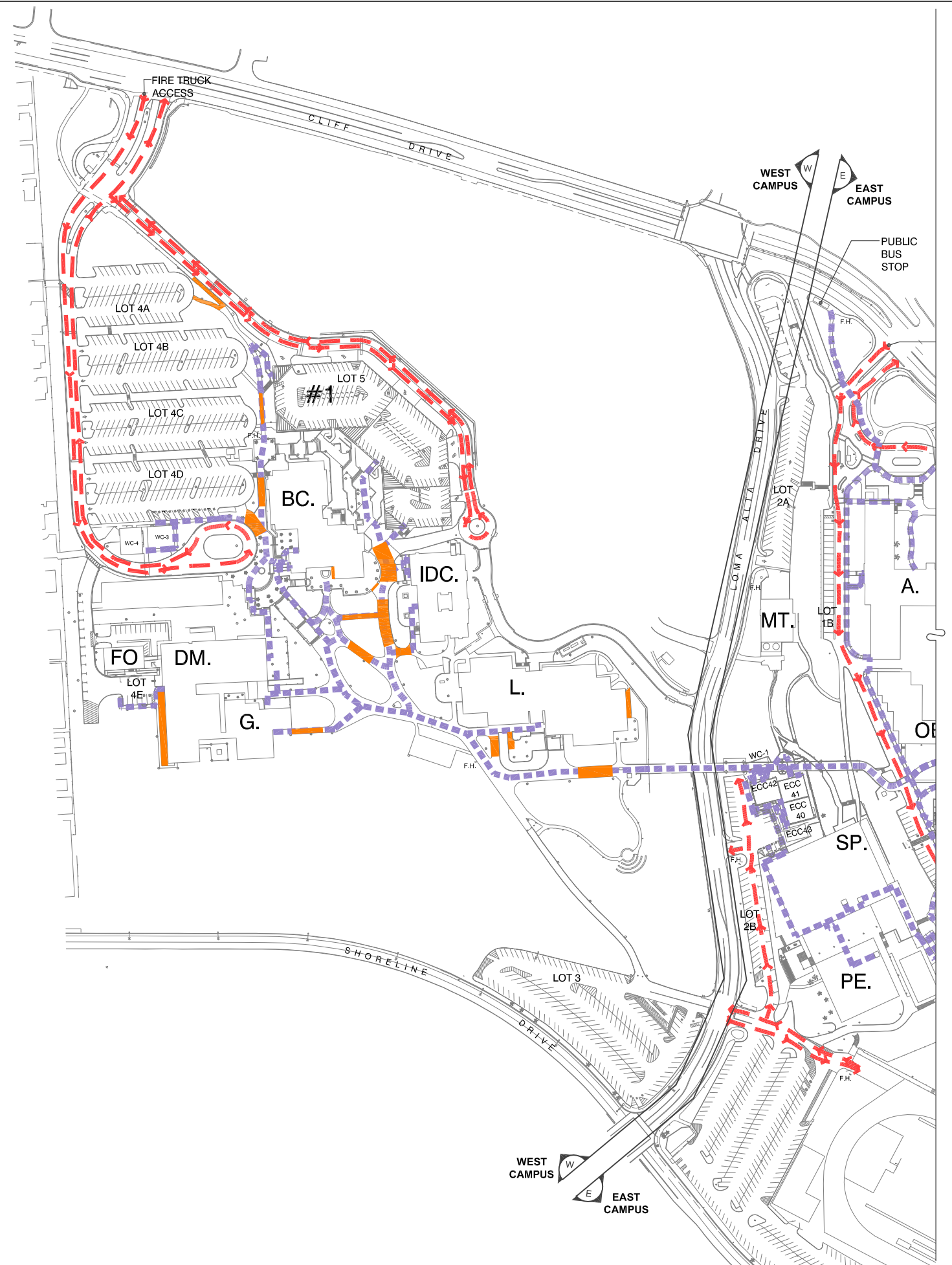

## WEST CAMPUS PLAN

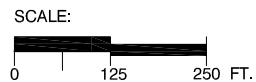

**RJC Inc.**  
Design & Construction Management

PO Box 60202  
SANTA BARBARA  
CA 93160-0202

Fax: (805)-585-3310  
Tel: (805) 692-9477  
Tel: (562)-392-8001  
E-mail: admin@rjc-inc.com



Main Campus - West Campus  
Santa Barbara City College

721 CLIFF DRIVE  
SANTA BARBARA  
CA 93109-1673

**ADA PATH OF TRAVEL ASSESSMENT**  
**LONGITUDINAL SLOPES ALONG THE PATH OF TRAVEL**

DATE: 2/19/16

**MW-5**



# LEGEND

- T** UNCLEAR PATH OF TRAVEL  
(E.G. SEPARATION OF PEDESTRIAN PATH VS. VEHICULAR PATH IS UNCLEAR)
- S** NON-COMPLIANT PATH OF TRAVEL SIGNAGE
- S** PATH OF TRAVEL SIGNAGE MISSING
- ⊖** ROOM I.D. NON-COMPLIANT OR MISSING
- ⊖** DOOR THRESHOLD NON-COMPLIANT
- ⊖** DOOR CLEARANCE NON-COMPLIANT
- F** ENTRYWAY FLOOR SURFACE NON-COMPLIANT
- ←** FIRE LANE
- ADA PATH OF TRAVEL

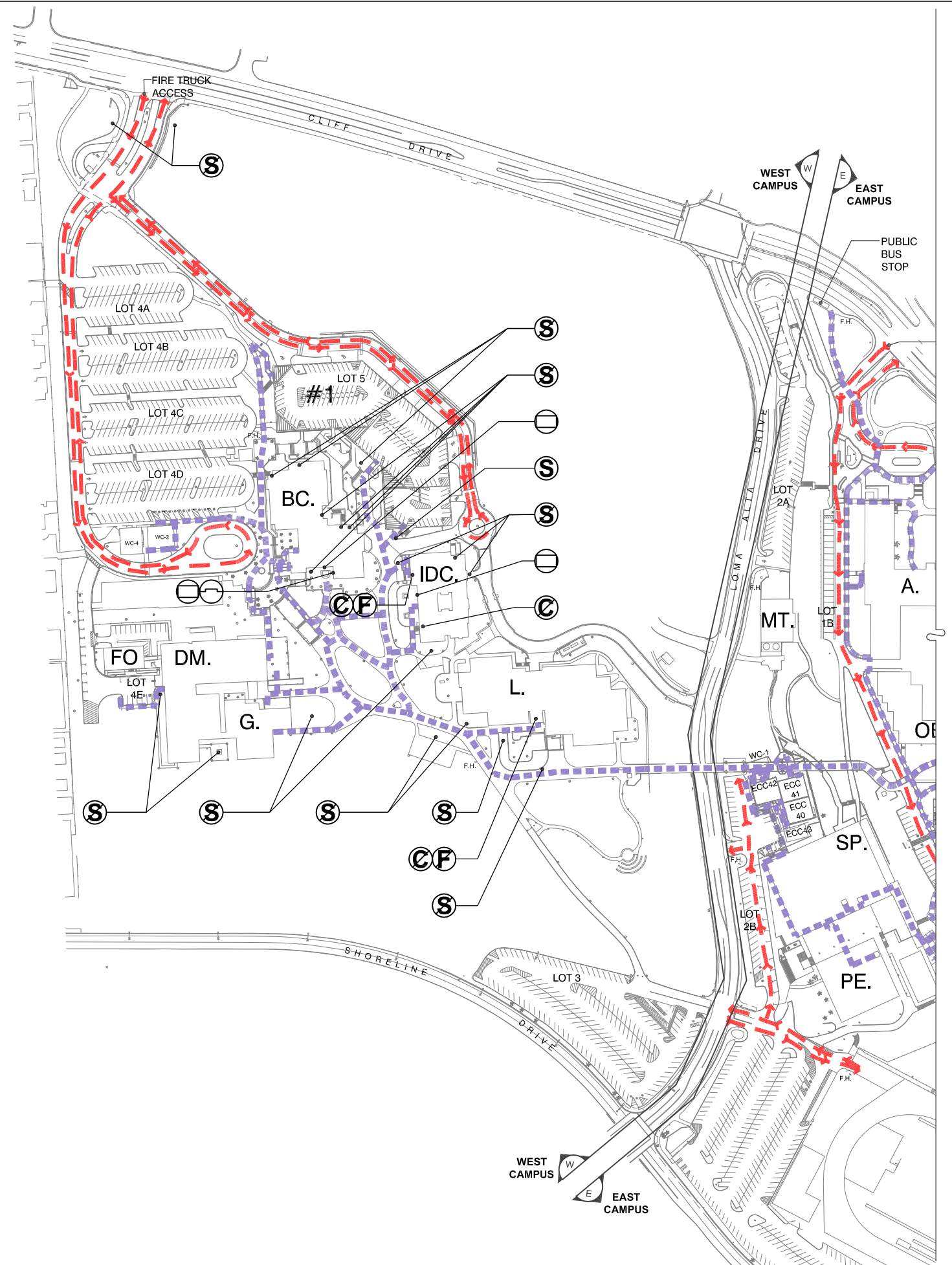

## WEST CAMPUS PLAN

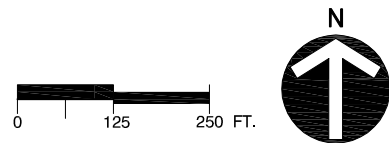

**RJC Inc.**  
Design & Construction Management

PO Box 60202  
SANTA BARBARA  
CA 93160-0202

Fax: (805)-585-3310  
Tel: (805) 692-9477  
Tel: (562)-392-8001  
E-mail: admin@rjc-inc.com



Main Campus - West Campus  
Santa Barbara City College

721 CLIFF DRIVE  
SANTA BARBARA  
CA 93109-1673

**ADA PATH OF TRAVEL ASSESSMENT**  
**PATH OF TRAVEL**

DATE: 2/19/16

**MW-6**

# LEGEND

**D** NO DETECTABLE WARNING AT FLUSH PEDESTRIAN/VEHICULAR INFLUENCE

**G** ABRUPT CHANGE IN LEVEL OR HAZARDOUS SURFACE FEATURE (E.G. GRATE)

**←** FIRE LANE

**---** ADA PATH OF TRAVEL

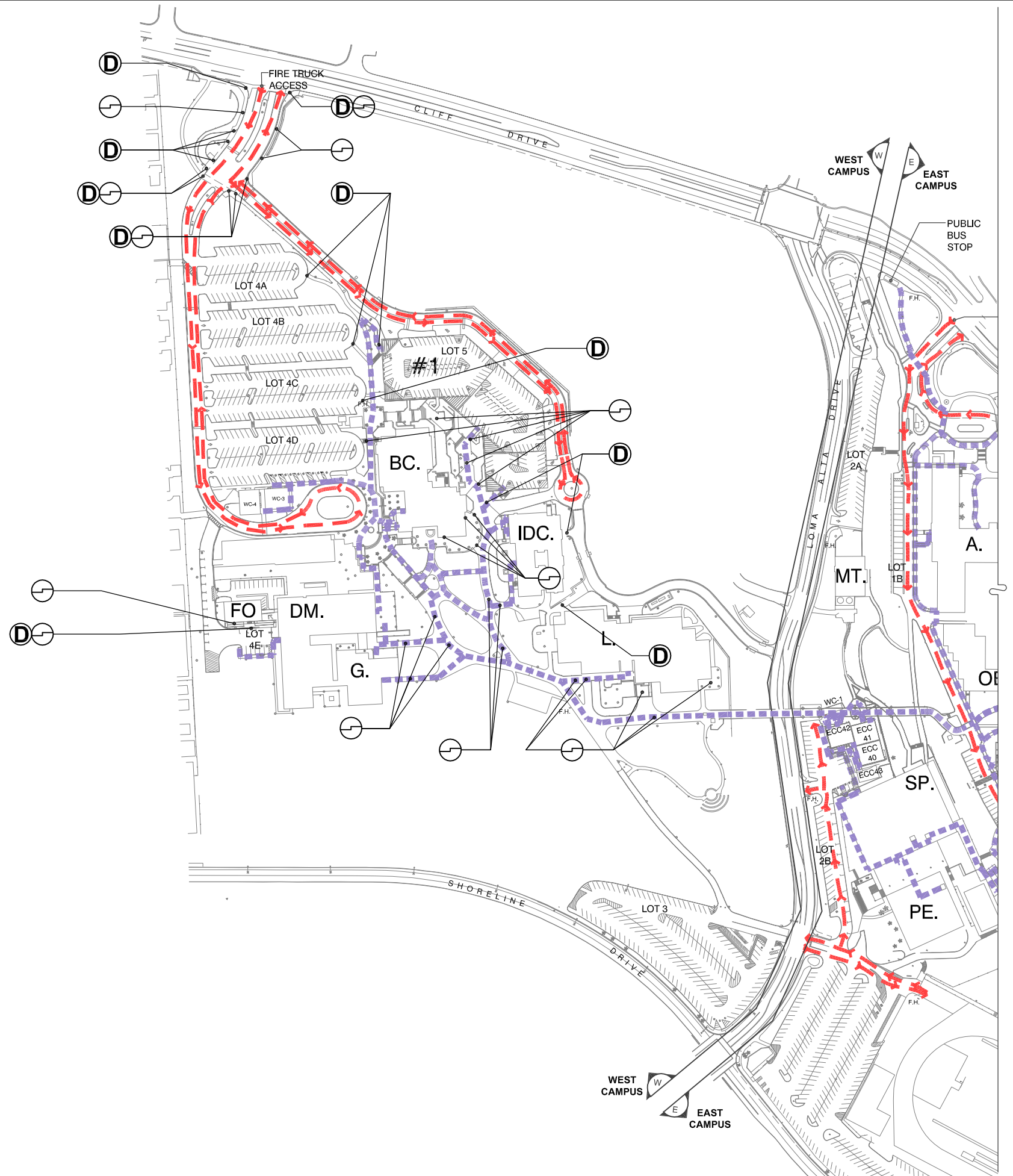

## WEST CAMPUS PLAN

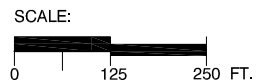

**RJC Inc.**  
Design & Construction Management

PO Box 60202  
SANTA BARBARA  
CA 93160-0202

Fax: (805)-585-3310  
Tel: (805) 692-9477  
Tel: (562)-392-8001  
E-mail: admin@rjc-inc.com



Main Campus - West Campus  
Santa Barbara City College











721 CLIFF DRIVE  
SANTA BARBARA  
CA 93109-1673

**ADA PATH OF TRAVEL ASSESSMENT  
POTENTIAL HAZARDOUS FEATURES**

DATE: 2/19/16

**MW-7**

# LEGEND

-  LONGITUDINAL SLOPE EXCEEDS 8.3% ON RAMPS
-  CROSS SLOPE EXCEEDS 2% ON RAMPS
-  INSUFFICIENT LANDING (SLOPE EXCEEDS 2%)
-  NO VISUAL WARNING OR FADED WARNING ON STAIRS
-  INCORRECT HANDRAIL RETURNS
-  INCORRECT HANDRAIL HEIGHTS
-  HANDRAIL NOT PROVIDED OR MISSING ON ONE SIDE OF RAMP OR STAIR
-  STAIR TREADS OR HEIGHTS NON-COMPLIANT
-  FIRE LANE
-  ADA PATH OF TRAVEL

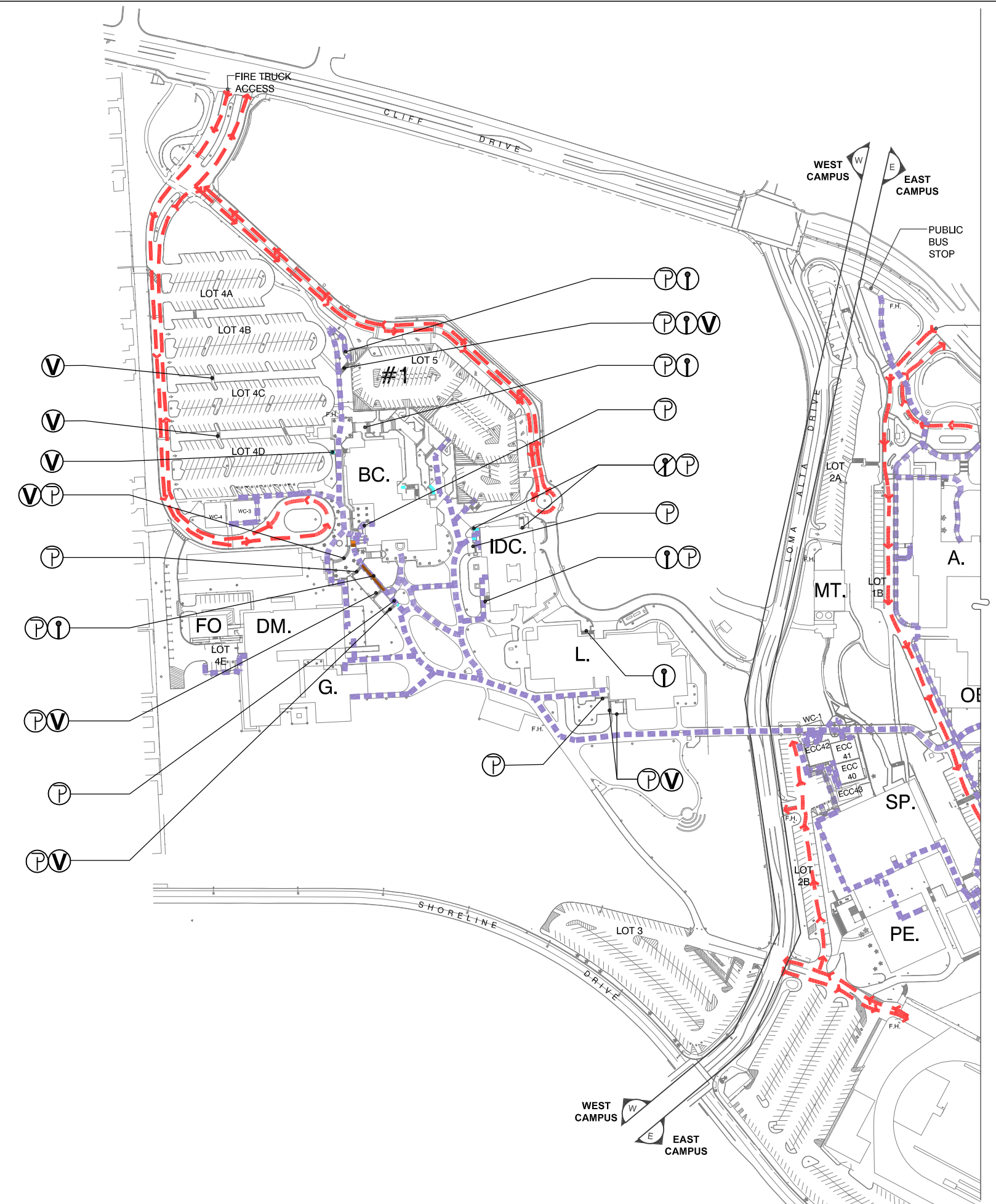

## WEST CAMPUS PLAN

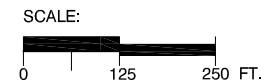

**RJC Inc.**  
Design & Construction Management

PO Box 60202  
SANTA BARBARA  
CA 93160-0202

Fax: (805)-585-3310  
Tel: (805) 692-9477  
Tel: (562)-392-8001  
E-mail: admin@rjc-inc.com



























Main Campus - West Campus  
Santa Barbara City College

721 CLIFF DRIVE  
SANTA BARBARA  
CA 93109-1673

**ADA PATH OF TRAVEL ASSESSMENT**  
**RAMPS AND STAIRS**

DATE: 2/19/16  
**MW-8**

# LEGEND

-  EXISTING PEDESTRIAN BRIDGE
-  EXISTING FACILITIES
-  PARKING AREAS
-  LONGITUDINAL SLOPE EXCEEDS 5% ALONG THE PATH OF TRAVEL OR 8.3% ON RAMP
-  ADA PARKING SLOPES EXCEED 2%
-  CROSS SLOPE EXCEEDS 2% ALONG THE PATH OF TRAVEL OR ON RAMP
-  INSUFFICIENT LANDING (SLOPE EXCEEDS 2%)
-  NO DETECTABLE WARNING AT FLUSH PEDESTRIAN/VEHICULAR INFLUENCE
-  NO VISUAL WARNING OR FADED WARNING ON STAIRS
-  INCORRECT HANDRAIL RETURNS
-  INCORRECT HANDRAIL HEIGHTS
-  HANDRAIL NOT PROVIDED OR MISSING ON ONE SIDE OF RAMP OR STAIR
-  ABRUPT CHANGE IN LEVEL OR HAZARDOUS SURFACE FEATURE (E.G. GRATE)
-  UNCLEAR PATH OF TRAVEL (E.G. SEPARATION OF PEDESTRIAN PATH VS. VEHICULAR PATH IS UNCLEAR)
-  NON-COMPLIANT PATH OF TRAVEL SIGNAGE
-  PATH OF TRAVEL SIGNAGE MISSING
-  ROOM I.D. NON-COMPLIANT OR MISSING
-  DOOR THRESHOLD NON-COMPLIANT
-  DOOR CLEARANCE NON-COMPLIANT
-  ENTRYWAY FLOOR SURFACE NON-COMPLIANT
-  STAIR TREADS OR HEIGHTS NON-COMPLIANT
-  NONCOMPLIANT CURB RAMP
-  NO CURB RAMP OR REQUIRED RAMP MISSING
-  FIRE LANE
-  ADA PATH OF TRAVEL

## WEST CAMPUS PLAN

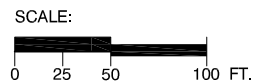

**RJC Inc.**  
Design & Construction Management

PO Box 60202  
SANTA BARBARA  
CA 93160-0202

Fax: (805)-585-3310  
Tel: (805) 692-9477  
Tel: (562)-392-8001  
E-mail: admin@rjc-inc.com



Main Campus - West Campus  
Santa Barbara City College

























721 CLIFF DRIVE  
SANTA BARBARA  
CA 93109-1673

**ADA PATH OF TRAVEL ASSESSMENT  
OVERALL**

DATE: 2/19/16

**MW-9.1**

# LEGEND

-  EXISTING PEDESTRIAN BRIDGE
-  EXISTING FACILITIES
-  PARKING AREAS
-  LONGITUDINAL SLOPE EXCEEDS 5% ALONG THE PATH OF TRAVEL OR 8.3% ON RAMP
-  ADA PARKING SLOPES EXCEED 2%
-  CROSS SLOPE EXCEEDS 2% ALONG THE PATH OF TRAVEL OR ON RAMP
-  INSUFFICIENT LANDING (SLOPE EXCEEDS 2%)
-  NO DETECTABLE WARNING AT FLUSH PEDESTRIAN/VEHICULAR INFLUENCE
-  NO VISUAL WARNING OR FADED WARNING ON STAIRS
-  INCORRECT HANDRAIL RETURNS
-  INCORRECT HANDRAIL HEIGHTS
-  HANDRAIL NOT PROVIDED OR MISSING ON ONE SIDE OF RAMP OR STAIR
-  ABRUPT CHANGE IN LEVEL OR HAZARDOUS SURFACE FEATURE (E.G. GRATE)
-  UNCLEAR PATH OF TRAVEL (E.G. SEPARATION OF PEDESTRIAN PATH VS. VEHICULAR PATH IS UNCLEAR)
-  NON-COMPLIANT PATH OF TRAVEL SIGNAGE
-  PATH OF TRAVEL SIGNAGE MISSING
-  ROOM I.D. NON-COMPLIANT OR MISSING
-  DOOR THRESHOLD NON-COMPLIANT
-  DOOR CLEARANCE NON-COMPLIANT
-  ENTRYWAY FLOOR SURFACE NON-COMPLIANT
-  STAIR TREADS OR HEIGHTS NON-COMPLIANT
-  NONCOMPLIANT CURB RAMP
-  NO CURB RAMP OR REQUIRED RAMP MISSING
-  FIRE LANE
-  ADA PATH OF TRAVEL

## WEST CAMPUS PLAN

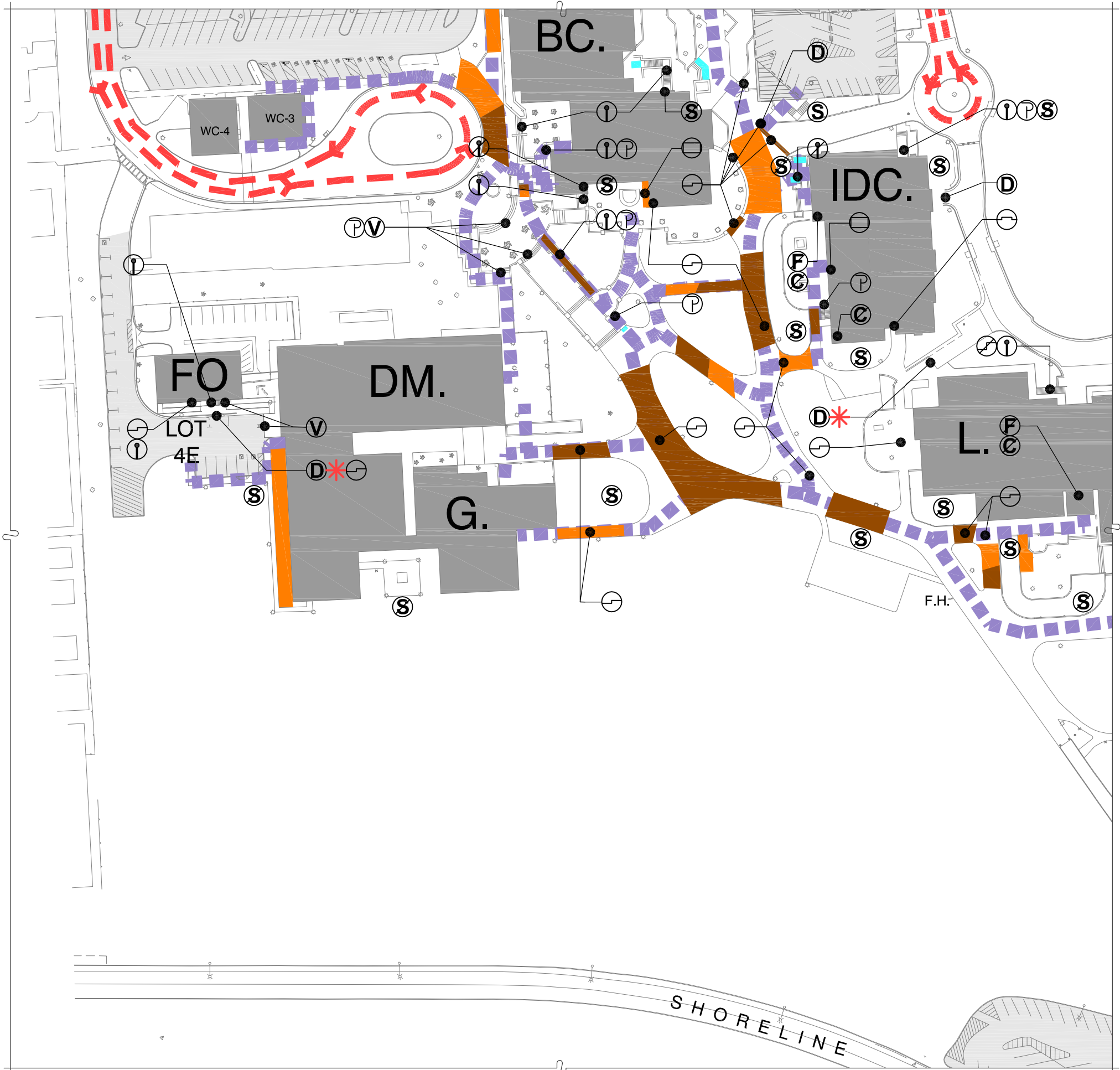
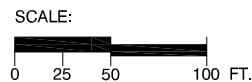

**RJC Inc.**  
Design & Construction Management

PO Box 60202  
SANTA BARBARA  
CA 93160-0202

Fax: (805)-585-3310  
Tel: (805) 692-9477  
Tel: (562)-392-8001  
E-mail: admin@rjc-inc.com



Main Campus - West Campus  
Santa Barbara City College

























721 CLIFF DRIVE  
SANTA BARBARA  
CA 93109-1673

**ADA PATH OF TRAVEL ASSESSMENT**  
**OVERALL**

DATE: 2/19/16

**MW-9.2**

# LEGEND

-  EXISTING PEDESTRIAN BRIDGE
-  EXISTING FACILITIES
-  PARKING AREAS
-  LONGITUDINAL SLOPE EXCEEDS 5% ALONG THE PATH OF TRAVEL OR 8.3% ON RAMPS
-  ADA PARKING SLOPES EXCEED 2%
-  CROSS SLOPE EXCEEDS 2% ALONG THE PATH OF TRAVEL OR ON RAMPS
-  INSUFFICIENT LANDING (SLOPE EXCEEDS 2%)
-  NO DETECTABLE WARNING AT FLUSH PEDESTRIAN/VEHICULAR INFLUENCE
-  NO VISUAL WARNING OR FADED WARNING ON STAIRS
-  INCORRECT HANDRAIL RETURNS
-  INCORRECT HANDRAIL HEIGHTS
-  HANDRAIL NOT PROVIDED OR MISSING ON ONE SIDE OF RAMP OR STAIR
-  ABRUPT CHANGE IN LEVEL OR HAZARDOUS SURFACE FEATURE (E.G. GRATE)
-  UNCLEAR PATH OF TRAVEL (E.G. SEPARATION OF PEDESTRIAN PATH VS. VEHICULAR PATH IS UNCLEAR)
-  NON-COMPLIANT PATH OF TRAVEL SIGNAGE
-  PATH OF TRAVEL SIGNAGE MISSING
-  ROOM I.D. NON-COMPLIANT OR MISSING
-  DOOR THRESHOLD NON-COMPLIANT
-  DOOR CLEARANCE NON-COMPLIANT
-  ENTRYWAY FLOOR SURFACE NON-COMPLIANT
-  STAIR TREADS OR HEIGHTS NON-COMPLIANT
-  NONCOMPLIANT CURB RAMP
-  NO CURB RAMP OR REQUIRED RAMP MISSING
-  FIRE LANE
-  ADA PATH OF TRAVEL

## WEST CAMPUS PLAN

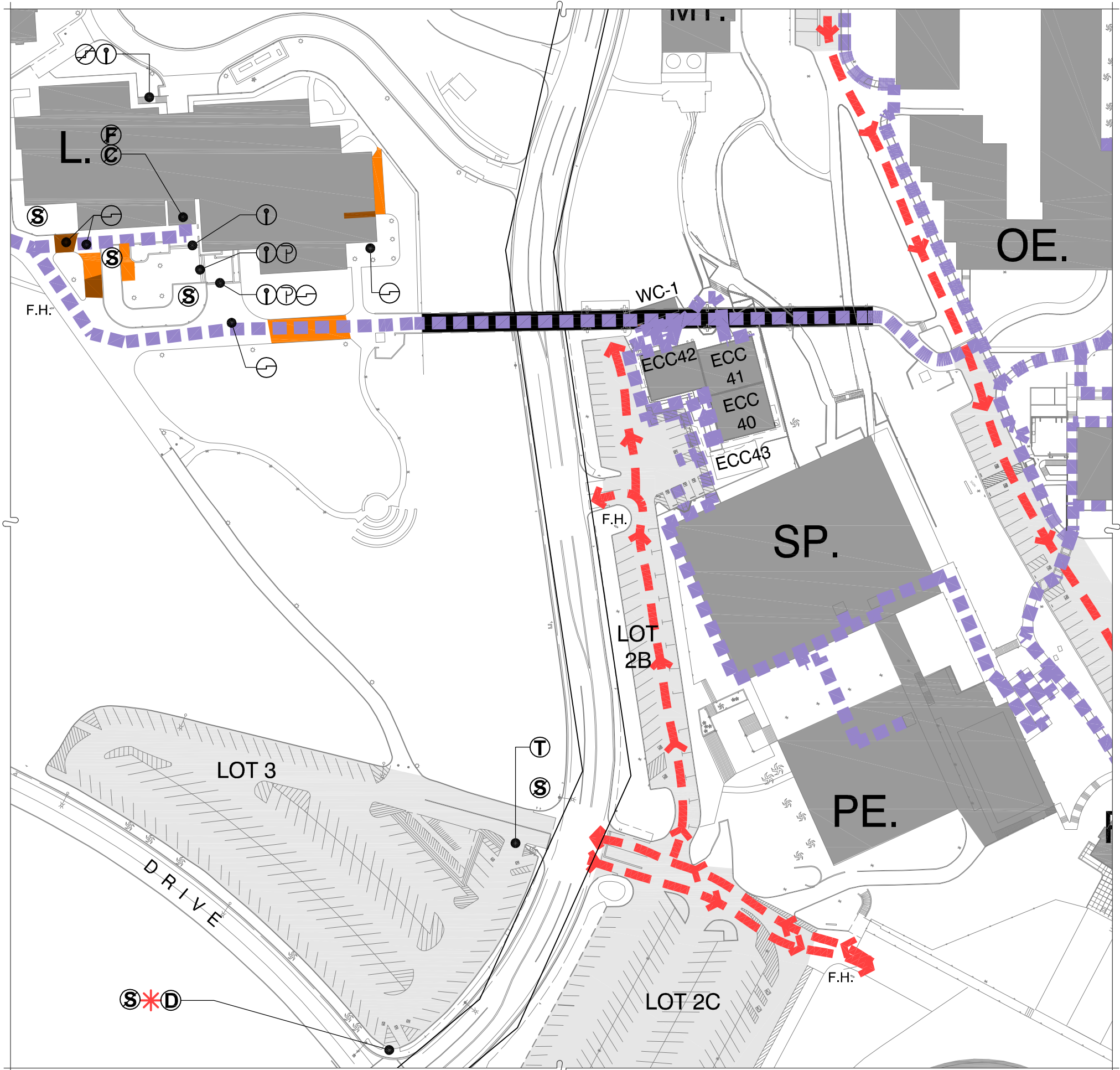
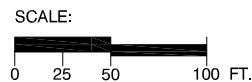

**RJC Inc.**  
Design & Construction Management

PO Box 60202  
SANTA BARBARA  
CA 93160-0202

Fax: (805)-585-3310  
Tel: (805) 692-9477  
Tel: (562)-392-8001  
E-mail: admin@rjc-inc.com



Main Campus - West Campus  
Santa Barbara City College

721 CLIFF DRIVE  
SANTA BARBARA  
CA 93109-1673

**ADA PATH OF TRAVEL ASSESSMENT**  
**OVERALL**

DATE: 2/19/16

**MW-9.3**

LOS OLIVOS STREET

# LEGEND

- EXISTING FENCE
- ADA PATH OF TRAVEL

CASTILLO STREET

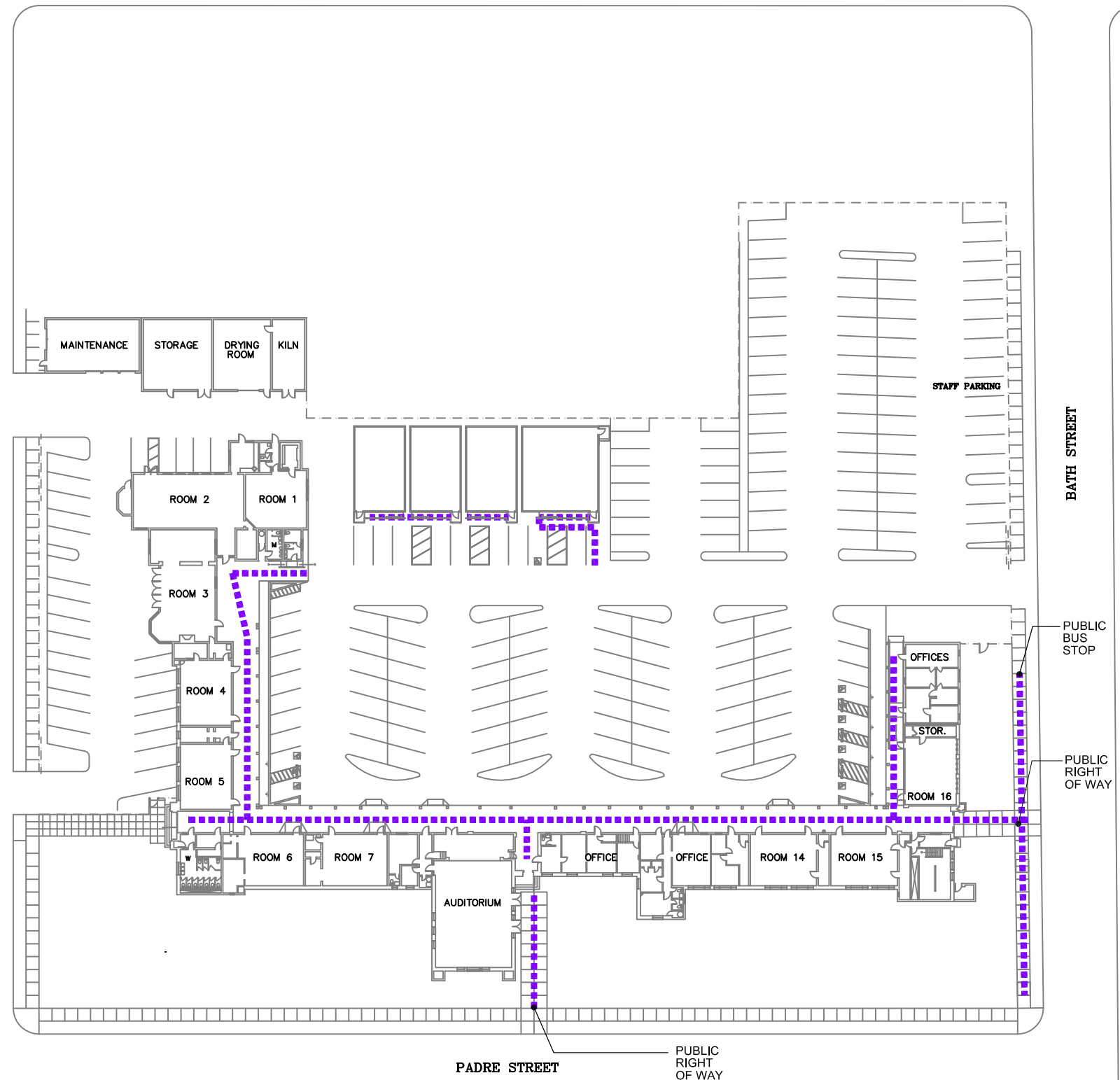

BATH STREET

PADRE STREET

PUBLIC RIGHT OF WAY

PUBLIC BUS STOP

PUBLIC RIGHT OF WAY

## CAMPUS PLAN

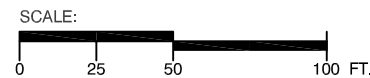

**RJC Inc.**  
Design & Construction Management

PO Box 60202  
SANTA BARBARA  
CA 93160-0202

Fax: (805)-585-3310  
Tel: (805) 692-9477  
Tel: (562)-392-8001  
E-mail: admin@rjc-inc.com



Schott Center  
Santa Barbara City College





310 W PADRE ST.  
SANTA BARBARA  
CA 93105-7100

**ADA PATH OF TRAVEL ASSESSMENT  
CAMPUS MAP**

DATE: 2/19/2016  
**SC-0**

LOS OLIVOS STREET

### LEGEND

-  EXISTING FACILITIES
-  PARKING AREAS
-  PROPERTY LINE
-  EXISTING FENCE
-  ADA PATH OF TRAVEL

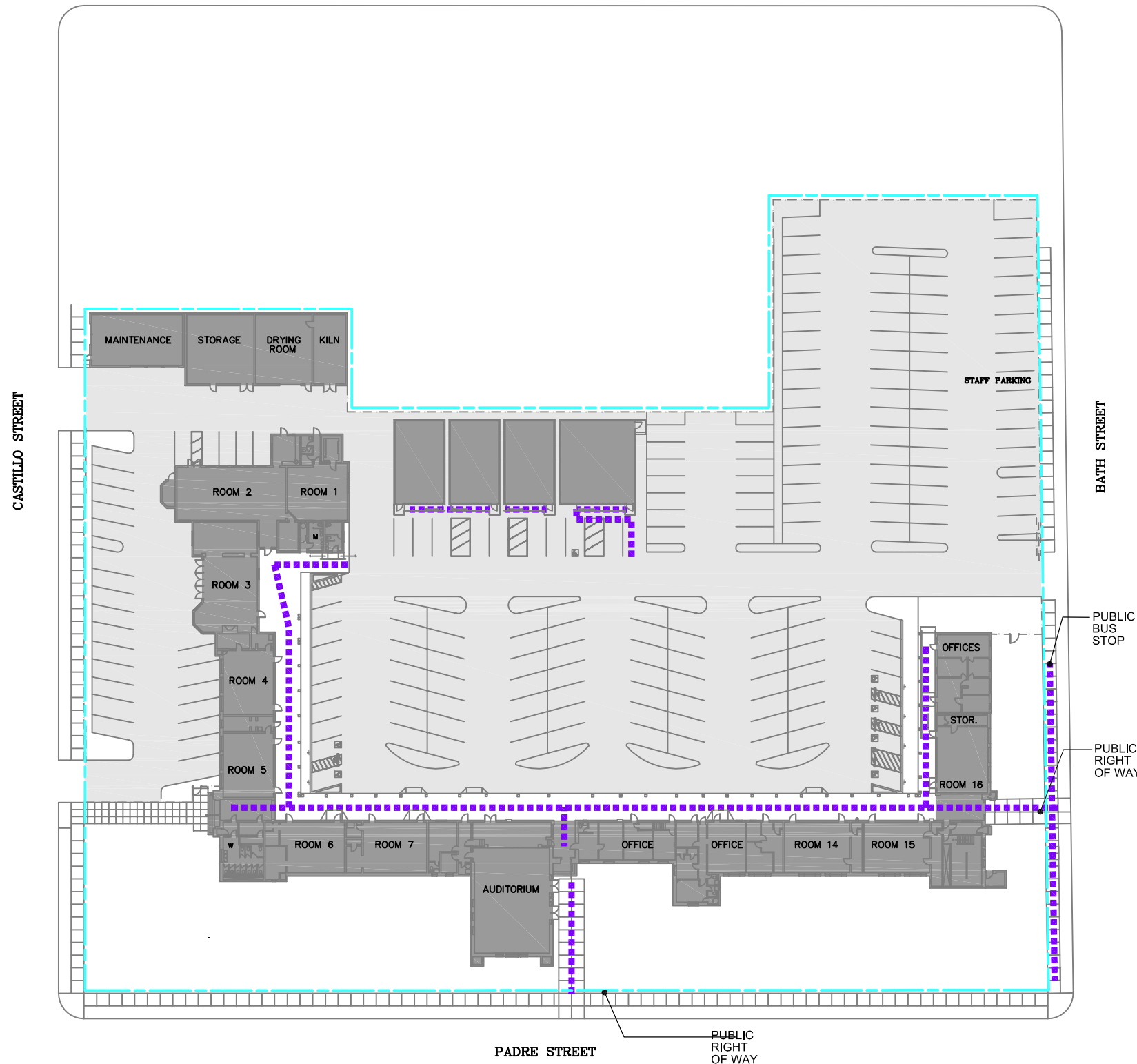

LOT#:	PARKING SPACES	ACCESSIBLE SPACES (1 VAN SPACE MIN.)	TOTAL SPACES PROVIDED	TOTAL ACCESSIBLE SPACES PROVIDED	TOTAL ACCESSIBLE SPACES REQUIRED
ALL	153	6+1 VAN=7	160	7	(4 MIN).

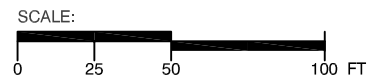

## CAMPUS PLAN





LOS OLIVOS STREET

# LEGEND

-  ADA PARKING SLOPES EXCEED 2%
-  EXISTING FENCE
-  ADA PATH OF TRAVEL

\*NOTE: ALL PARKING SLOPES ON THE SCHOTT CAMPUS ARE COMPLIANT

CASTILLO STREET

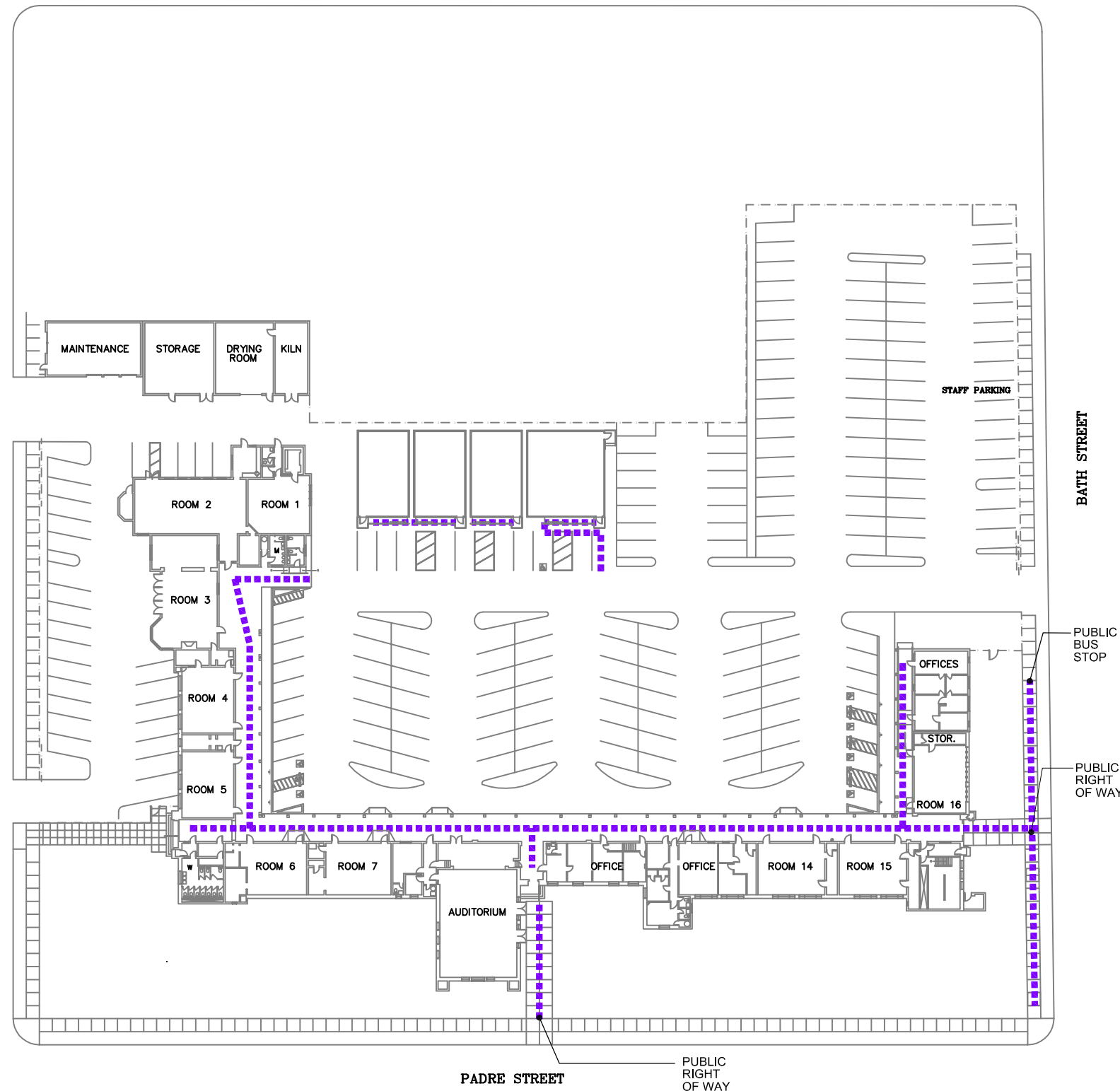

BATH STREET

PUBLIC BUS STOP

PUBLIC RIGHT OF WAY

PADRE STREET

PUBLIC RIGHT OF WAY

## CAMPUS PLAN



**RJC Inc.**  
Design & Construction Management

PO Box 60202  
SANTA BARBARA  
CA 93160-0202

Fax: (805)-585-3310  
Tel: (805) 692-9477  
Tel: (562)-392-8001  
E-mail: admin@rjc-inc.com



Schott Center  
Santa Barbara City College

310 W PADRE ST.  
SANTA BARBARA  
CA 93105-7100



**ADA PATH OF TRAVEL ASSESSMENT  
ACCESSIBLE PARKING STALLS**

DATE: 2/19/2016

**SC-2**

LOS OLIVOS STREET

# LEGEND

-  CROSS SLOPE EXCEEDS 2%, ALONG THE PATH OF TRAVEL
-  EXISTING FENCE
-  ADA PATH OF TRAVEL

CASTILLO STREET

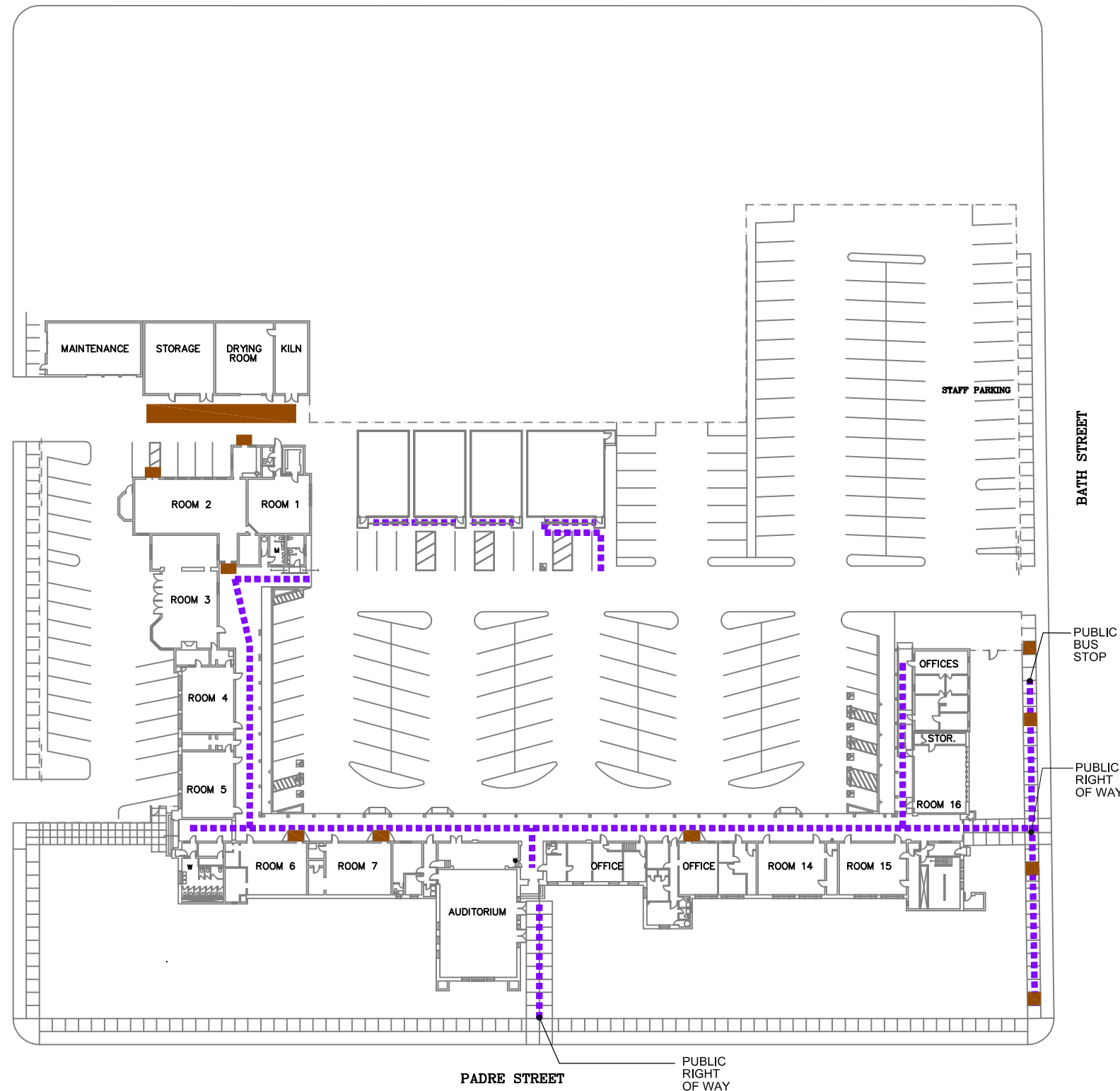

BATH STREET

PUBLIC BUS STOP

PUBLIC RIGHT OF WAY

PADRE STREET

PUBLIC RIGHT OF WAY





## CAMPUS PLAN

SCALE: 0 25 50 100 FT.



LOS OLIVOS STREET

# LEGEND

-  INSUFFICIENT LANDING (SLOPE EXCEEDS 2%)
-  NONCOMPLIANT CURB RAMP
-  NO CURB RAMP OR REQUIRED RAMP MISSING
-  EXISTING FENCE
-  ADA PATH OF TRAVEL

CASTILLO STREET



BATH STREET

PUBLIC BUS STOP

PUBLIC RIGHT OF WAY

PADRE STREET

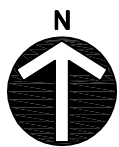
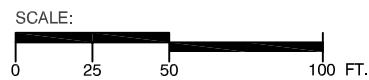

PUBLIC RIGHT OF WAY

## CAMPUS PLAN



LOS OLIVOS STREET

# LEGEND

-  LONGITUDINAL SLOPE EXCEEDS 5% ALONG THE PATH OF TRAVEL
-  EXISTING FENCE
-  ADA PATH OF TRAVEL

CASTILLO STREET

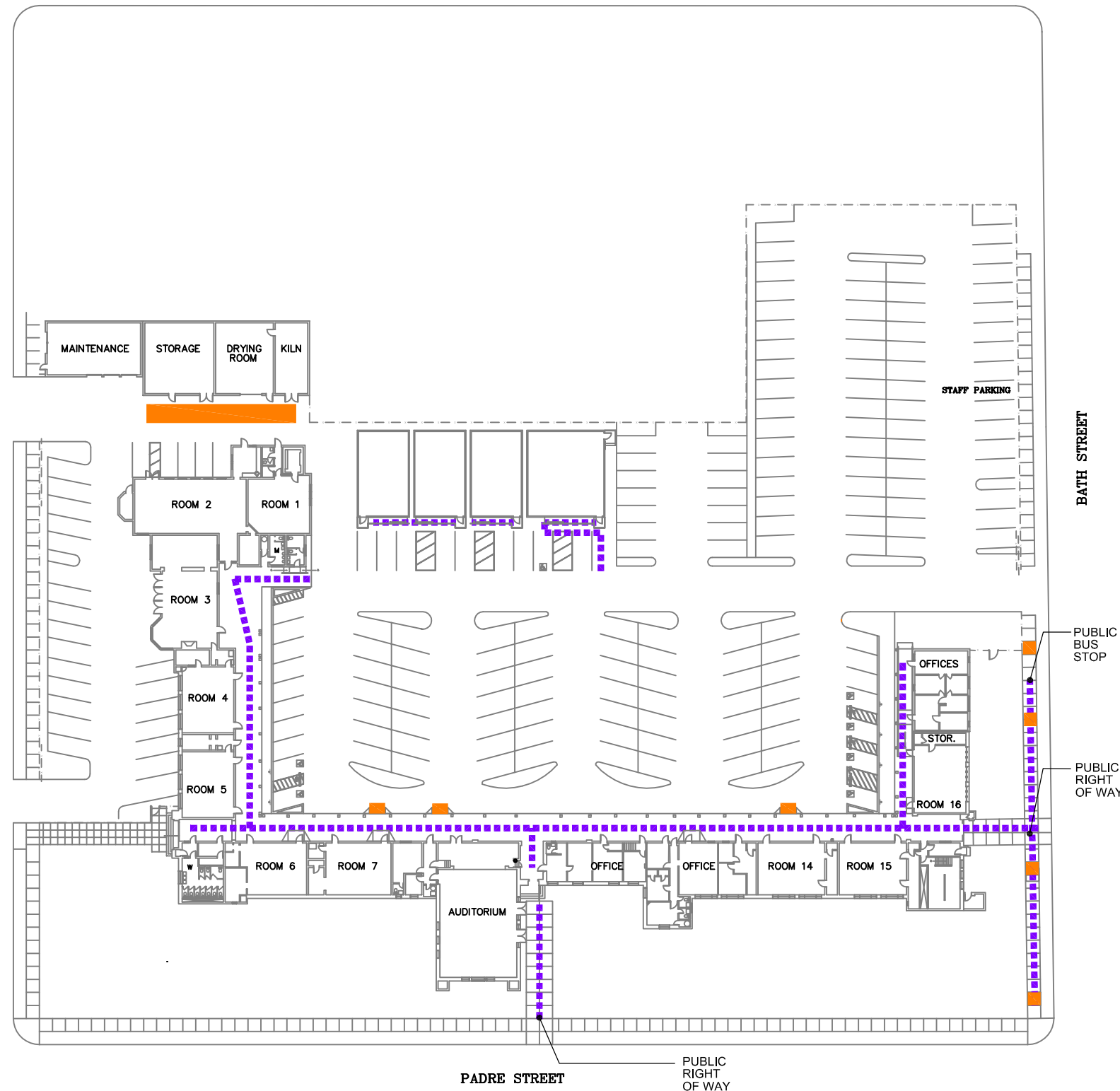

BATH STREET

PUBLIC BUS STOP

PUBLIC RIGHT OF WAY

PADRE STREET

PUBLIC RIGHT OF WAY

## CAMPUS PLAN

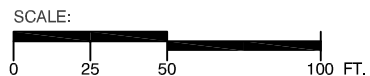

**RJC Inc.**  
Design & Construction Management

PO Box 60202  
SANTA BARBARA  
CA 93160-0202

Fax: (805)-585-3310  
Tel: (805) 692-9477  
Tel: (562)-392-8001  
E-mail: admin@rjc-inc.com



Schott Center  
Santa Barbara City College

310 W PADRE ST.  
SANTA BARBARA  
CA 93105-7100

**ADA PATH OF TRAVEL ASSESSMENT**  
**LONGITUDINAL SLOPES**

DATE: 2/17/2016

**SC-5**

LOS OLIVOS STREET

# LEGEND

- UNCLEAR PATH OF TRAVEL (E.G. SEPARATION OF PEDESTRIAN PATH VS. VEHICULAR PATH IS UNCLEAR)
- NON-COMPLIANT PATH OF TRAVEL SIGNAGE
- PATH OF TRAVEL SIGNAGE MISSING
- ROOM I.D. NON-COMPLIANT OR MISSING
- DOOR THRESHOLD NON-COMPLIANT
- DOOR CLEARANCE NON-COMPLIANT
- ENTRYWAY FLOOR SURFACE NON-COMPLIANT
- EXISTING FENCE
- ADA PATH OF TRAVEL

CASTILLO STREET

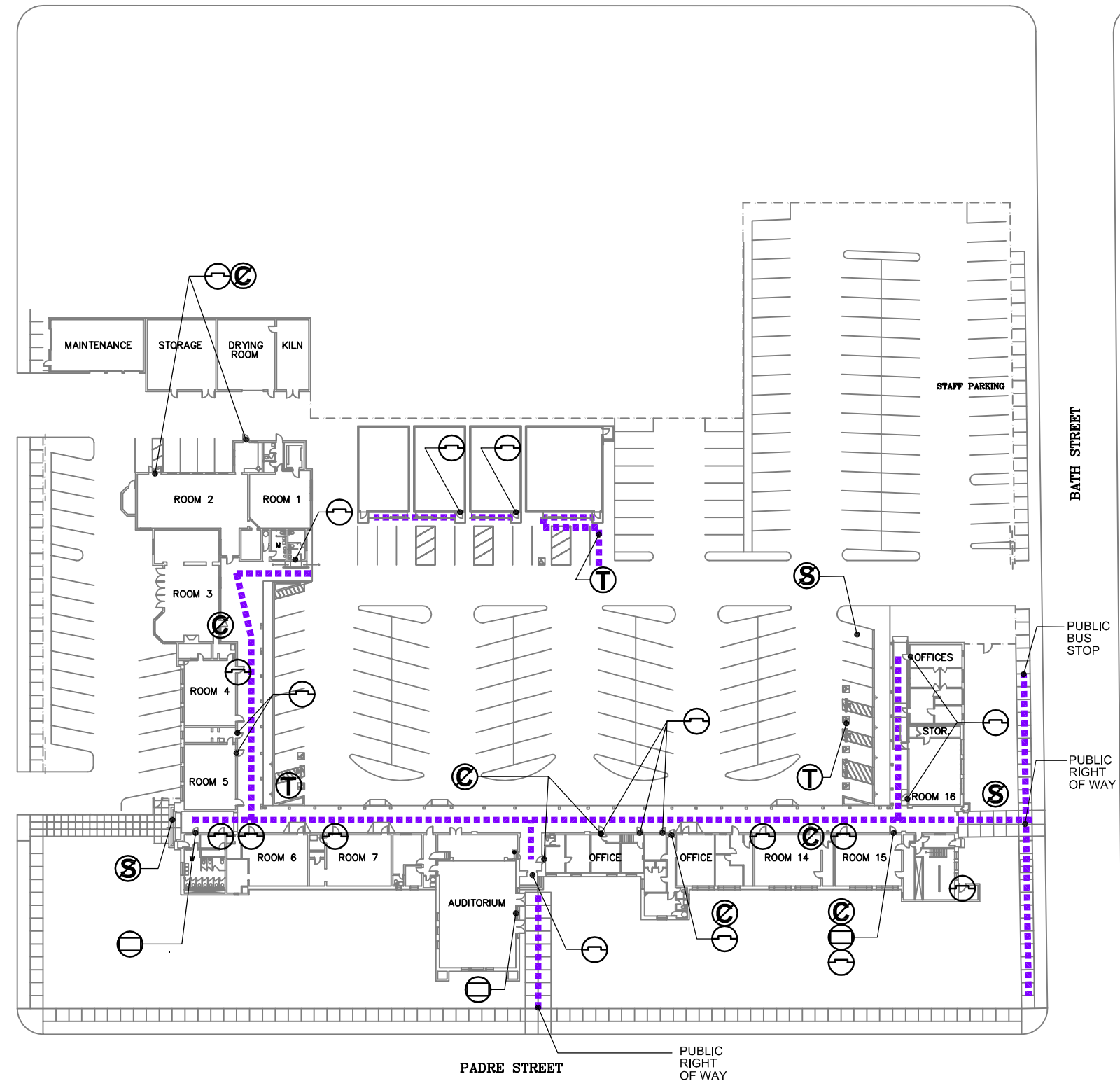

BATH STREET

PUBLIC BUS STOP

PUBLIC RIGHT OF WAY

PADRE STREET



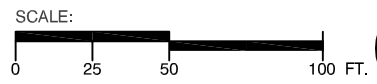

PUBLIC RIGHT OF WAY

## CAMPUS PLAN



LOS OLIVOS STREET

### LEGEND

-  NO DETECTABLE WARNING AT FLUSH PEDESTRIAN/VEHICULAR INFLUENCE
-  ABRUPT CHANGE IN LEVEL OR HAZARDOUS SURFACE FEATURE (E.G. GRATE)
-  EXISTING FENCE
-  ADA PATH OF TRAVEL

CASTILLO STREET

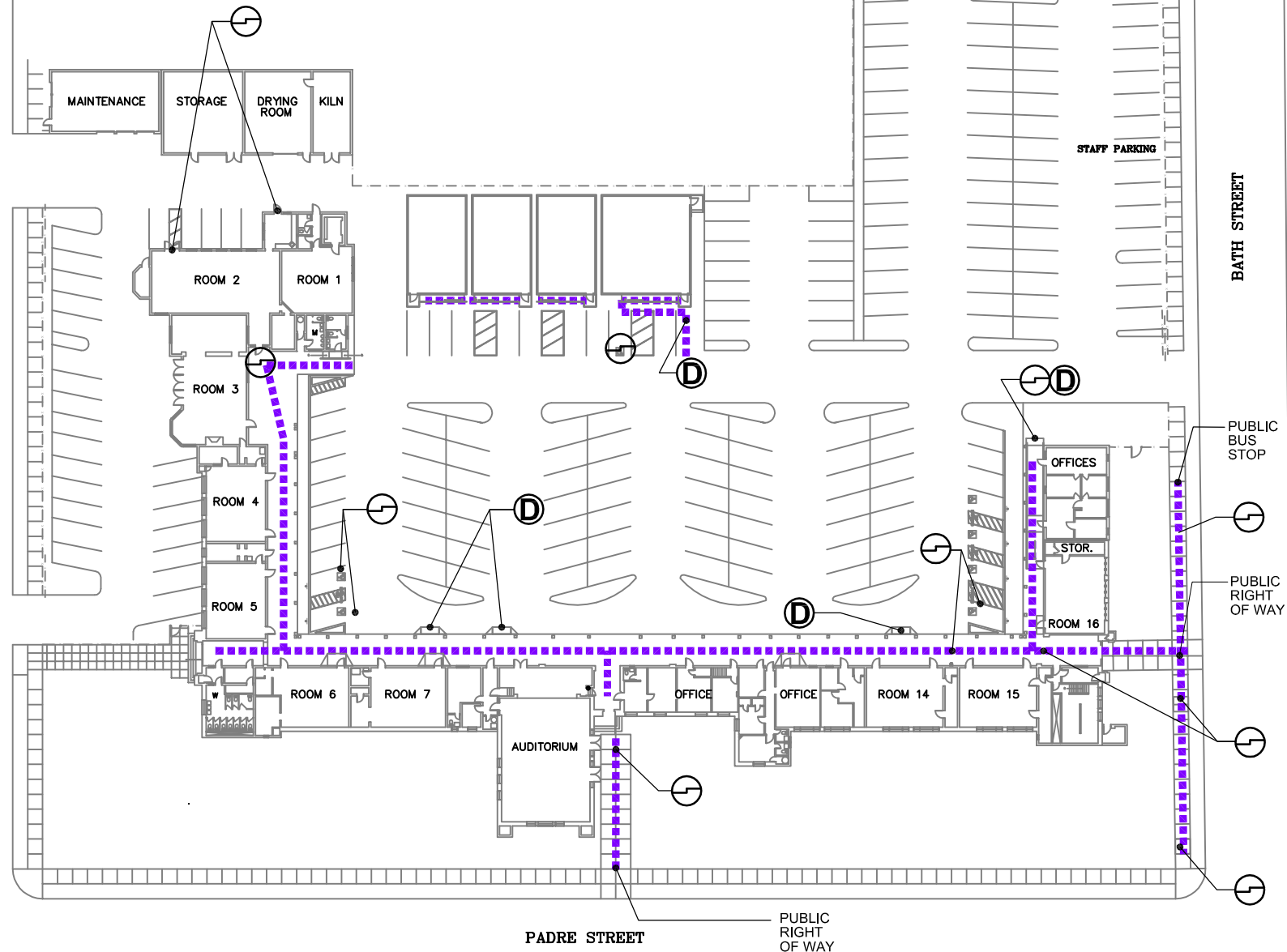

BATH STREET

PUBLIC BUS STOP

PUBLIC RIGHT OF WAY

PADRE STREET





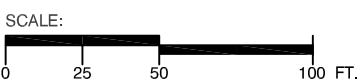





PUBLIC RIGHT OF WAY

## CAMPUS PLAN



LOS OLIVOS STREET

# LEGEND

-  LONGITUDINAL SLOPE EXCEEDS 8.3% ON RAMPS
-  CROSS SLOPE EXCEEDS 2% ON RAMPS
-  INSUFFICIENT LANDING (SLOPE EXCEEDS 2%)
-  NO VISUAL WARNING OR FADED WARNING ON STAIRS
-  INCORRECT HANDRAIL RETURNS
-  INCORRECT HANDRAIL HEIGHTS
-  HANDRAIL NOT PROVIDED OR MISSING ON ONE SIDE OF RAMP OR STAIR
-  STAIR TREADS OR HEIGHTS NON-COMPLIANT
-  EXISTING FENCE
-  ADA PATH OF TRAVEL

CASTILLO STREET

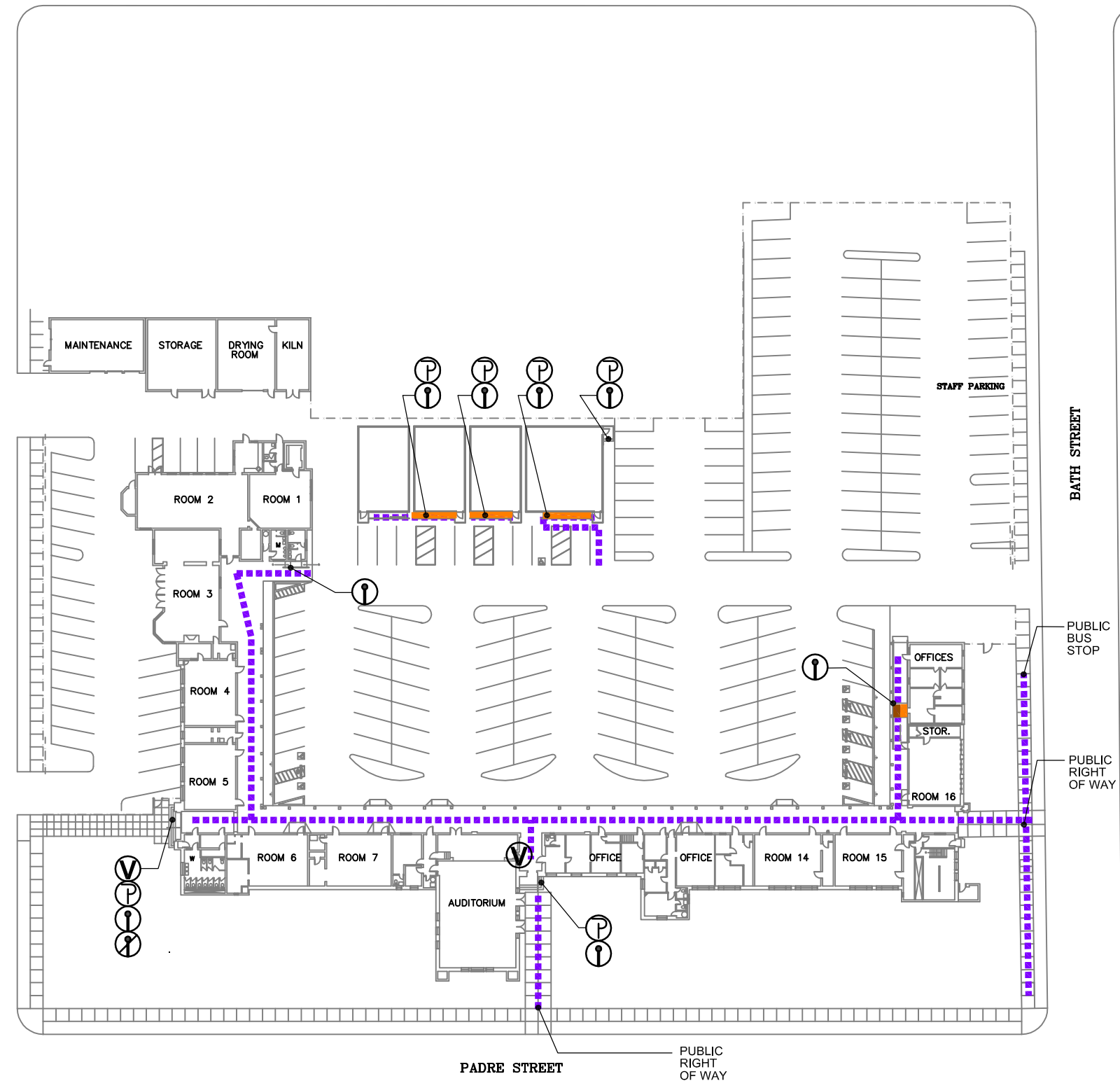

BATH STREET

PUBLIC BUS STOP

PUBLIC RIGHT OF WAY

PADRE STREET

PUBLIC RIGHT OF WAY

## CAMPUS PLAN

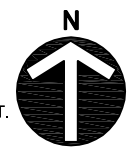
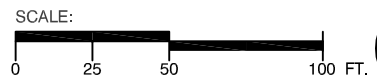

LOS OLIVOS STREET

CASTILLO STREET

BATH STREET

























PADRE STREET

PUBLIC RIGHT OF WAY

PUBLIC BUS STOP

PUBLIC RIGHT OF WAY

# LEGEND

-  EXISTING FACILITIES
-  PARKING AREAS
-  LONGITUDINAL SLOPE EXCEEDS 5% ALONG THE PATH OF TRAVEL OR 8.3% ON RAMPS
-  ADA PARKING SLOPES EXCEED 2%
-  CROSS SLOPE EXCEEDS 2%, ALONG PATH OF TRAVEL OR ON RAMPS
-  INSUFFICIENT LANDING (SLOPE EXCEEDS 2%)
-  NO DETECTABLE WARNING AT FLUSH PEDESTRIAN/VEHICULAR INFLUENCE
-  NO VISUAL WARNING OR FADED WARNING ON STAIRS
-  INCORRECT HANDRAIL RETURNS
-  INCORRECT HANDRAIL HEIGHTS
-  HANDRAIL NOT PROVIDED OR MISSING ON ONE SIDE OF RAMP OR STAIR
-  ABRUPT CHANGE IN LEVEL OR HAZARDOUS SURFACE FEATURE (E.G. GRATE)
-  UNCLEAR PATH OF TRAVEL (E.G. SEPARATION OF PEDESTRIAN PATH VS. VEHICULAR PATH IS UNCLEAR)
-  NON-COMPLIANT PATH OF TRAVEL SIGNAGE
-  PATH OF TRAVEL SIGNAGE MISSING
-  ROOM I.D. NON-COMPLIANT OR MISSING
-  DOOR THRESHOLD NON-COMPLIANT
-  DOOR CLEARANCE NON-COMPLIANT
-  ENTRYWAY FLOOR SURFACE NON-COMPLIANT
-  STAIR TREADS OR HEIGHTS NON-COMPLIANT
-  NONCOMPLIANT CURB RAMP
-  NO CURB RAMP OR REQUIRED RAMP MISSING
-  PROPERTY LINE
-  EXISTING FENCE
-  ADA PATH OF TRAVEL

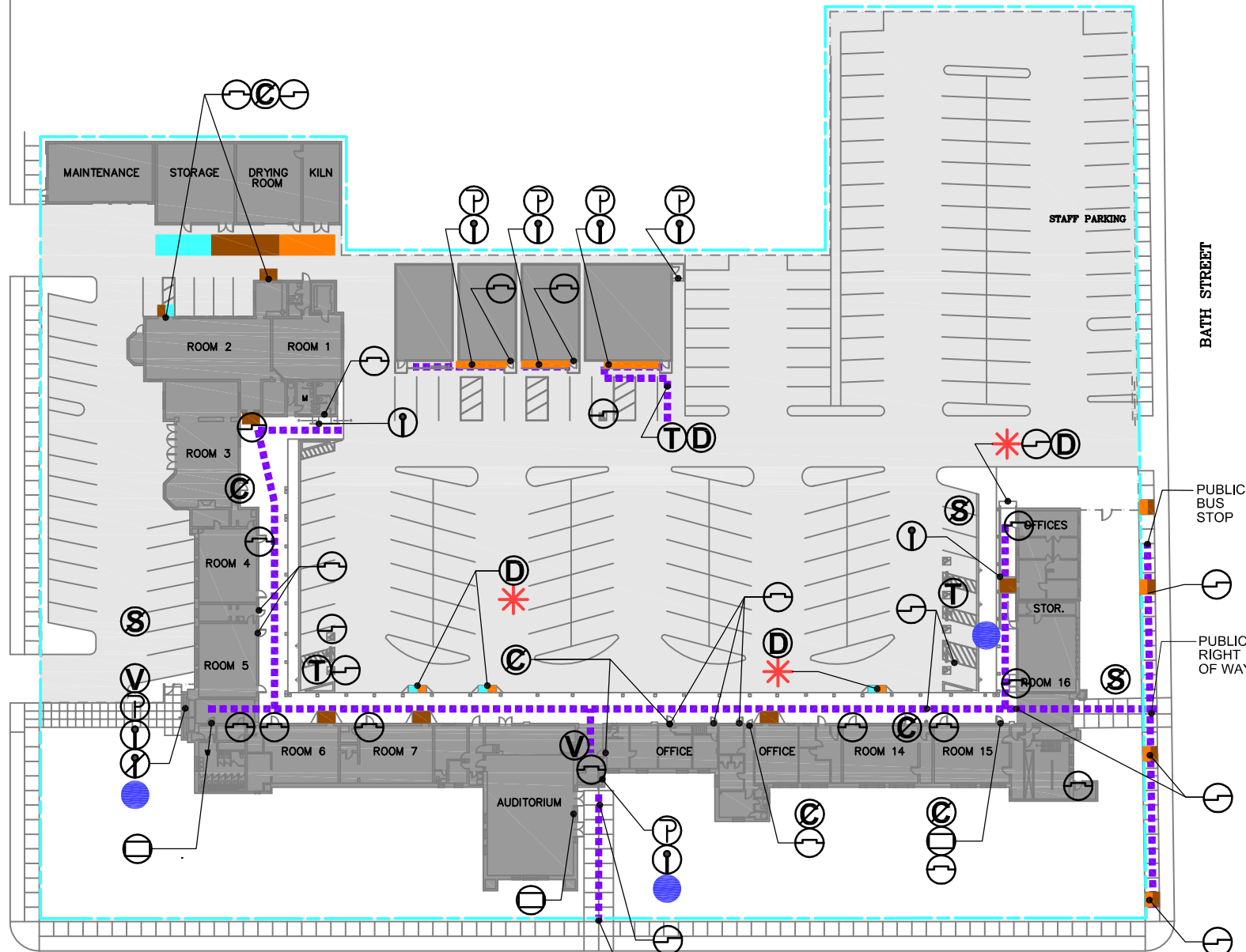

## CAMPUS PLAN

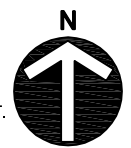
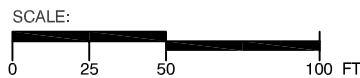



# Facility Condition Assessment Report ADMINISTRATION BUILDING

*Prepared for*



**SANTA BARBARA CITY COLLEGE**

**Santa Barbara City College – Main Campus  
721 Cliff Drive  
Santa Barbara, CA 93109**

RJC Project No: 2015.46



*Prepared by*  
**RJC Inc.**

**Facility Condition Assessment Report**  
**Santa Barbara City College – Main Campus**  
**Administration Building**  
**721 Cliff Drive**  
**Santa Barbara, CA 93109**

March 4, 2016

---

---

*TABLE OF CONTENTS*

*Description*

<i><u>Number</u></i>	<i><u>Page</u></i>
1. Facility Description	2
2. Major Findings	3
3. Site Findings	4
4. Architectural Findings	5
5. Mechanical Findings	6
6. Electrical Findings	7
7. ADA Building Descriptive Report	8
8. Inspector's notes	9
9. Summary	9

*Appendix*

A. Building Plans	10
a. Lower Level	11
b. First Floor	12
c. Second Floor	13
d. Third Floor	14
B. Photo Log & Narrative	15-48
C. Existing Building Details	49-50

# **1. Facility Description**

Year Built: 1939  
Building Area: 95,000 square feet (Administration and OE)  
Construction type: II FR  
Occupancy: A3

The Administration building is in the Art Deco Mission Revival aesthetic, originally built in 1939 as the Industrial Arts Education building. It is a concrete structure, slab on grade with concrete reinforced footings and structural columns, concrete floor diaphragms and sheer walls, and non-ductile concrete frames. The Spanish tile roof is supported by metal trusses, and interior walls are metal stud partitions. This historical building is prominently located on the east side of campus at the main entrance on a sloping site, and encompasses 4 levels. A new wing was added in the early 1970's resulting in an "H" shaped building with a variety of programs and offices housed in each of the wings. Built in 1976, the Occupational Educational (OE) building serves as an extension of the Administration building by connecting to the southeast wing and wrapping back around toward the southwest wing creating an outdoor space currently called the Auto Quad.

An elevator is located between the northwest and southwest wings, providing wheel chair access to the upper levels, as well as access to the upper portion of campus.

These buildings house classrooms, labs and office space for student support and administrative functions of various departments. The primary user groups of this building are Nursing, Health Technologies, Computer Science, Construction Technology, Drafting/CAD, Graphic Design & Photography, Interior Design, Occupational Education, SBCC Foundation and Superintendent/President's Offices, and the Information Technology Division.

Since its original construction in 1939, the Administration building has been remodeled or renovated during no less than 40 individual projects. Major remodels included a first floor remodel in 1965, second floor electrical remodel in 1970, Northeast building wing addition in 1971, Interior renovations in 1978, Electronics and Computer Labs in 1988, AC remodel in 1987, first floor remodel in 1990, O/E building addition in 1993, Automotive Technology roof in 1993, first floor HVAC remodel in 1994, Information resources second floor remodel in 1995, Health Technologies second floor remodel in 1997, AHU addition and Chiller placement in 1997, exterior ADA access pathway & landscaping in 1998, AHU replacement 2000, New Primary Electrical Service 2002, restroom renovations in 2002, A211 Roof replacement in 2004, Computer Room AC upgrade & New Electrical Emergency System in 2004 and Duplicating Room remodel in 2008.

## **2. Major Findings**

Although selected rooms and areas have been renovated previously, neither the Administration building nor the OE building have had a comprehensive renovation to allow the buildings to function as modern, higher education office and instructional facilities in a cohesive, well planned manner. This has resulted in a disjointed and inefficient layout that confuses students and visitors when navigating through the building. Modernization is also necessary to meet current standards for building accessibility and fire/life safety. Building code deficiencies such as ADA Accessibility, Fire Life Safety and Energy (Title 24) need to be resolved.

A seismic study was conducted in 1996, and the findings indicate deficiencies are observed, but not significant enough to adversely affect life-safety performance of the building. Some exterior sheer walls and roof overhangs show hairline shrinkage cracks.

Data and communication cabling upgrades are necessary in many spaces to integrate to campus information networking.

The lower level exterior walkway has water intrusion in addition to damage in the ceiling system.

The central outdoor space between the buildings encompasses the Auto Quad. This area serves as hands on instructional space for the Automotive Services & Technology programs, and thus automobiles in various states of repair are parked adjacent the buildings. There are hazardous materials contained in plastic outdoor containers set against the exterior west wall. The concrete Quad surface is stained and damaged from automotive chemicals. Adjacent these stains, there are two storm drains centered in the Auto Quad, which drain directly to the ocean. Removal and remediation of hazardous substances will be required at this location.

The South portion of the OE building has an outdoor stairway connecting the two levels, and its walls, ceiling, concrete stair and handrail finishes are badly damaged due to the outdoor elements. The upper landing storefront system is rusted, the flooring is badly pitted and the adjacent concrete is spalling.

There are restrooms both for students and staff on all levels. While most restrooms throughout the building have been made ADA compliant, the accommodations have been made in a piecemeal fashion. The finishes, colors, fixtures and equipment are dated, antiquated and damaged from years of use, have not been renovated for at least 14 years, and are in dire need of repair and restoration. Wall and floor tiles are damaged by water, in addition to surface holes due to equipment relocation. ADA restroom signage is non-compliant. The layouts and configurations are inefficient and poorly designed.

The building has (8) eight drinking fountains, a few of which are of the era of the original building. Only (2) two of these drinking fountains are a hi-low fountains, and thus the building does not meet the 50% ratio of hi-low accessible drinking fountains.

### **3. Site Findings**

The building sits on a slope, creating entrances at various levels of the buildings.

The area around the buildings are both paved and landscaped, offering several locations in which to enter the building as a mixture of wheelchair ramps and stairs.

At multiple locations along the designated path of travel going around the exterior of the building, the cross slopes exceed the maximum allowed 2%, and longitudinal slopes exceed the maximum allowed 5%. At some of the excessive cross slopes, the sidewalk slopes towards the vehicular roadway. There are various points along the path of travel that have abrupt changes in level or hazardous surface features. Many of the adjacent curb ramps serving this pathway are non-compliant, with excessive slopes, insufficient landings, and missing detectable warning pavers at the vehicular influence. There is inadequate or non-existent path of travel signage, making exterior wayfinding difficult for users.

The visual warnings on multiple stair treads are faded or missing. At both stairs and ramps, many handrail returns are non-compliant and some handrail heights do not meet the current minimum height of 34" and the gripping surface is too wide.

The ramped approach to the northeast building entrance is excessively long, and requires a landing mid-way up and handrails to meet current ADA codes. This concrete ramp shows significant cracks and spalling, and the adjacent exterior half wall is also cracked.

The path of travel from the public transportation bus stop on Cliff Drive to the building and campus is not ADA compliant. There are excessive cross and longitudinal slopes, multiple abrupt changes in level and/or hazardous surface features, non-compliant curb ramps and no level landing at the sidewalk location to board the bus. Curb ramps in this area are also non-compliant.

## **4. Architectural Findings**

Approximately 10,000 sf. of building space is in reasonable condition, 2,835 sf is in fair condition and 19,775 sf is in poor condition. Even with the various additions and partial remodels over the life of the building, many spaces have outdated or deteriorating room finishes, utilities, lab and instructional equipment, HVAC systems, exterior corridor lighting, elevator equipment, doors finishes, casework, signage, and a variety of ADA compliance issues.

Interior walls are painted the standard Cottage White color. Floor finishes include, Spanish tile, Vinyl, VCT, Linoleum and ceramic tile. Although some wall and floor finishes have been refurbished during various renovation projects, numerous walls, wall corners and floor finishes throughout the buildings are damaged, outdated, and are in general need of repair. Wall base materials are delaminated from the walls in many locations. Exterior floor surfaces near the elevator do not provide sufficient slip resistance.

The window systems throughout the building are a combination of original wood, newer metal systems and aluminum storefront systems. Window types include fixed, slider, casement and awning. There are a varying degrees of faded, peeling paint, material joint and sealing issues, and water intrusion damage.

The interior and exterior doors throughout the buildings are constructed with a variety of materials and styles. Many doors are the original stained, lacquer finished wood, some are painted metal or wood, and others are plastic laminate faced. Exterior doors have large glass lite areas, interior office and classroom doors have smaller glass lites, or none at all. Some larger glass lites are not constructed with safety glass. Most door finishes are in a deteriorated condition requiring refinishing or repainting. A large majority of the door hardware has been replaced with ADA compliant lever type pulls, but some auxiliary doors such as equipment, janitor or storage rooms still have round non-compliant door knobs. Multiple doors with automatic door openers exceed the maximum opening force and maximum closing speed allowed by code, making it difficult for users to operate.

Although selected rooms and areas have been renovated previously, neither the Administration building nor the OE building have had a comprehensive renovation to allow the buildings to function as modern, higher education office and instructional facilities in a cohesive well planned manner. This has resulted in a disjointed and inefficient layout that confuses students and visitors when navigating through the building. Modernization is also necessary to meet current standards for building accessibility and fire/life safety. Building code deficiencies such as Structural Safety, ADA Accessibility, Fire Life Safety and Energy (Title 24) need to be resolved.

The overhang roof system is original Spanish tile, nail attached through mineral cap sheet with areas of built up roofing over wood decking. There are various locations where the Spanish tile is broken and damaged. It is unknown if the roof tile tie-down system meets current Department of the State Architect (DSA) requirements. Water intrusion issues are causing ongoing maintenance demands at the first floor exterior corridor ceiling and roof overhang.

Many lay-in tegular ceiling tiles are stained, damaged, require replacement, and at various locations grid members are bent and require refurbishment. The suspended ceiling system may no longer meet current code requirements and regulations, has not been upgraded, and would greatly benefit from refurbishing.

## **5. Mechanical Findings**

HVAC equipment and plumbing fixtures require replacement for future maintenance and serviceability. HVAC ducts run vertically up the face of the exterior northern wall to the rooftop units. The building has undergone multiple renovations, upgrading areas as it becomes necessary. There has been no single overall upgrade to the HVAC system as a whole.

Throughout the life of the building various mechanical equipment has been added including AHUs, chillers, fan coils, and split heat pumps to accommodate floor plan and occupancy changes.

The Administration mechanical system is a combination of new, added/replaced equipment consisting of (4) four pipe hydronic heating and cooling system with a gas fired boiler in the basement and air cooled rooftop chillers.

The existing 1932 boiler was replaced with a Raypack HI-DELTA LoNox boiler in 1999 in the basement and provides heat to the entire building. In 1999 (1) one air handler unit was installed on the roof to serve Lecture Hall 211.

Air conditioning is provided in limited critical locations throughout the building via multiple mini-split heat pump systems which provide heating and/or cooling. Cooling is only provided at computer server rooms. All mini-split systems lack outside air ventilation and most likely use obsolete R-22 refrigerant.

The AHUs, chillers, fan coils, split heat pumps, piping, piping insulation, pumps, valving, controls and accessories are at the end of their the useful life and should be replaced

Some exhaust fans are original and some have been replaced on an as needed basis.

There is debris and storage items blocking the minimum clear working space around all mechanical indoor equipment.

All equipment was properly marked. Rooftop units, piping and curbs meet minimum clearances, supports are secured to the structure, properly seismically restrained, and vibration isolation is present. The disconnecting means are present, and are in-site and readily accessible. Exterior ducts are protected by a weatherproof barriers, and duct smoke detectors were present. The outside air intake vent distances and air inlet screen protection are in place. The exhaust discharge clearances to walls, roofs, operable openings and grade are within code requirements. Rooftop condensate lines discharge flows to drains connected to sewer system. Refrigerant pipe and tubing are compliant. Boiler shutoff valves are present in the supply/return piping. Pipe hangers/ anchors/supports are correct and are within proper spacing.

## **6. Electrical Findings**

The Administration Building is powered by a 200 KW generator which powers non- life safety loads.

The generator: 200 KW (200KVA) 480/277 volt three phase  
Transfer switch: 400 amp feeds EHA and ELB (Machine Room)  
Panel EHA: 400 amp bus 400 amp panel (Room 300E)  
112 KVA 480/120-208 (Room 330E)  
Panel ELA 400 amp 120/208  
Panel: ELB (Machine Room) feeds Panel N1A and N1AA located in Room 162.  
Demand load: 107KVA (129 amps @ 480 volts)  
Spare capacity: 93 KVA (112 amps @ 480volts)

In 2006, a new generator was installed on the slope behind the east side of the building to provide back-up capacity for the Emergency/Life-Safety loads. These “Emergency/Life-Safety” electrical loads are isolated in a manner in which only these loads are connected to the building emergency wiring system. Non-life safety or “stand-by” loads cannot be added to the life safety portion of the existing electrical system. Emergency lights and exit signs in these buildings are powered separately with built-in unit batteries and are completely isolated from the generator systems.

A feasibility study was conducted in 2009 to assess the possible electrical options for providing additional power loads onto the existing generators which only provide power to non-life safety loads. The Administration building’s existing generator was studied with regard to spare “back-up power” and additional capacity, to determine the actual power draw on the generator during a power outage. The results indicated the generator was only slightly loaded and that it has more than enough reserve capacity to connect additional non-life safety loads to the generator system, dependent upon available load capacities.

Although the main interior corridor lighting and ceilings were recently renovated, many outdoor corridors have outdated, non-matching lighting fixtures with surface mounted painted conduit. Many fixtures are missing lenses and are in need of routine maintenance.



## ***7. ADA Building Descriptive Report***

Several entry egress door thresholds exceed the ½” maximum height, without being beveled at a 2:1 slope. Minimum maneuvering clearances are not met at all exterior first floor office doors, and numerous doors do not have ADA compliant entry signage.

Large building directory signs provide maps, room names and arrows to direct the user throughout the building, but proper interior way finding signs at ramps, stairs, and changes in direction are inadequate.

The ramped building entrances at the north side of the Auto Quad do not provide adequate maneuvering clearances, do not have level landings or compliant handrails, and pipe bollards reduce the minimum clear path width to these ramps.

The vertical circulation is accommodated by an outdated elevator, which does not meet all current codes for accessibility. The elevator floor designations are missing at the jambs of each floor, the elevator doors do not remain open for a minimum of 20 seconds after encountering an obstruction, and there is no verbal annunciator to announce the floor at which the car is stopping.

## **8. Inspectors' notes**

The building has been generally well maintained, is fully functional for its intended uses, but is in need of a major modernization to be brought up to the level of other college and educational buildings of this type. This historical building is salvageable and is recommended for modernization versus replacement.

## **9. Summary**

The following code, safety and maintenance issues were discovered at and around the Administration building and its remediation is recommended:

1. Numerous walking paths around the building site exceed the maximum allowed 2% cross slope and 5% longitudinal slopes.
2. An ADA compliant path of travel from the main public transit location does not exist.
3. All building entrances are not fully ADA compliant and properly accessible.
4. Some ramps and stair handrails are not ADA compliant.
5. The northeast exterior ramped entrance walkway half wall and ramp are in very poor condition, are cracked, and require replacement.
6. The elevator serves as a means to provide wheelchair access to the upper portion on the campus, and is not fully ADA compliant.
7. The mechanical basement is missing a portion of an upper wall serving electrical equipment. It is unfinished, does not interface properly with the top landing of the access stairs and poses a falling hazard.
8. The uni-sex restroom 247 in the northeast 2<sup>nd</sup> floor wing has signage indicating it is an accessible restroom. This restroom is not ADA compliant and is in very poor condition. Accurate signage and/or modernization to current codes is required.
9. The first floor exterior walkway ceiling has water intrusion damage and in need of repair.
10. Flooring throughout the building is in poor condition and requires restoration or replacement.
11. Damaged doors and windows throughout the building require refurbishment or replacement.
12. All restrooms are in poor condition and require refurbishment and modernization.
13. Adequate number of hi-low ADA compliant drinking fountains are not provided.
14. Overall building and site signage is inadequate and requires renovation.
15. Data and communication cabling upgrades are necessary in many spaces to integrate to campus information networking.
16. The OE building 2<sup>nd</sup> floor hallway, and the stairway connecting the first floor to the AutoQuad are in very poor condition and require restoration.
17. The AutoQuad requires hazardous materials remediation and revisions to chemical drainage collection at the catch basin.

# **APPENDIX A BUILDING PLANS**

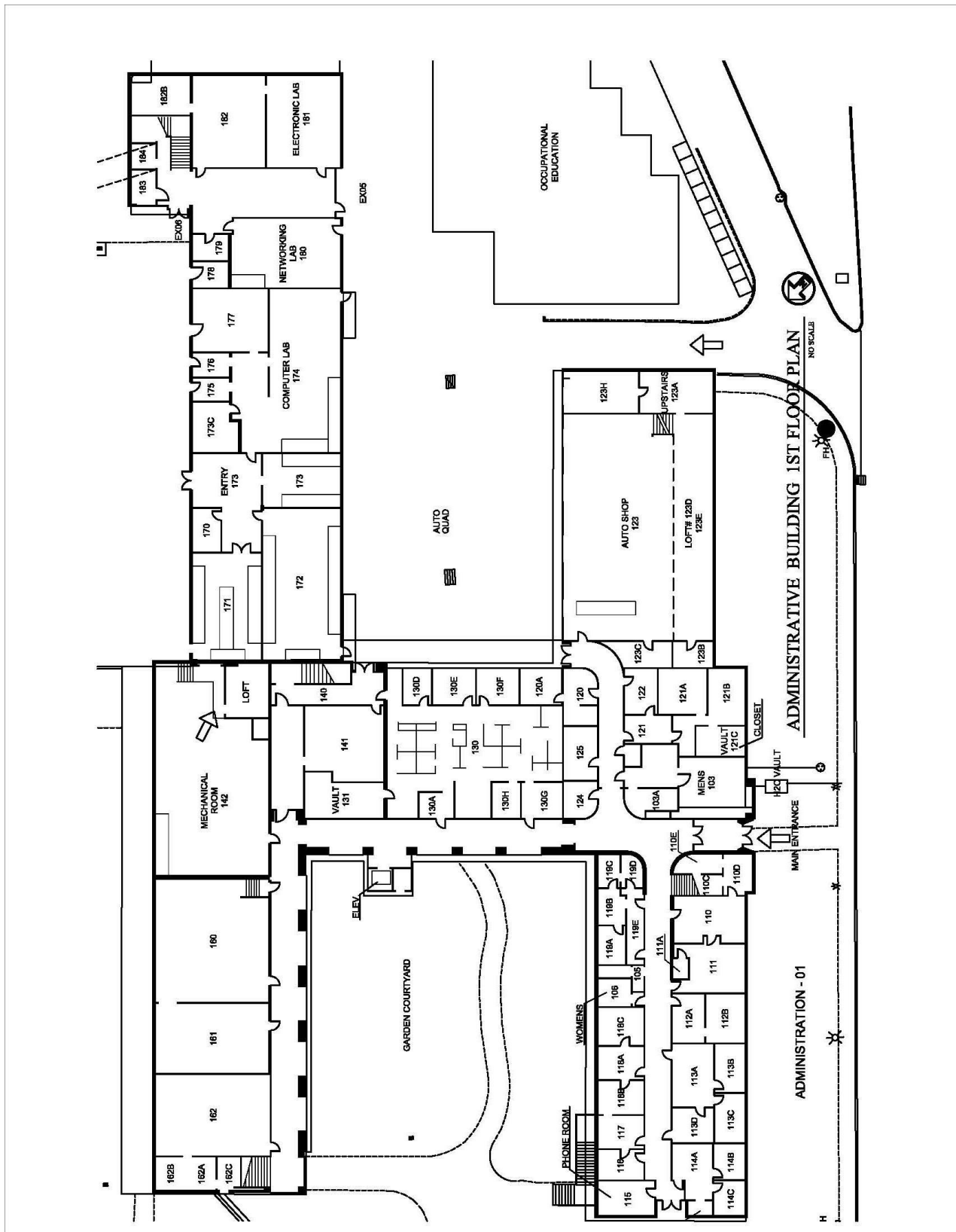

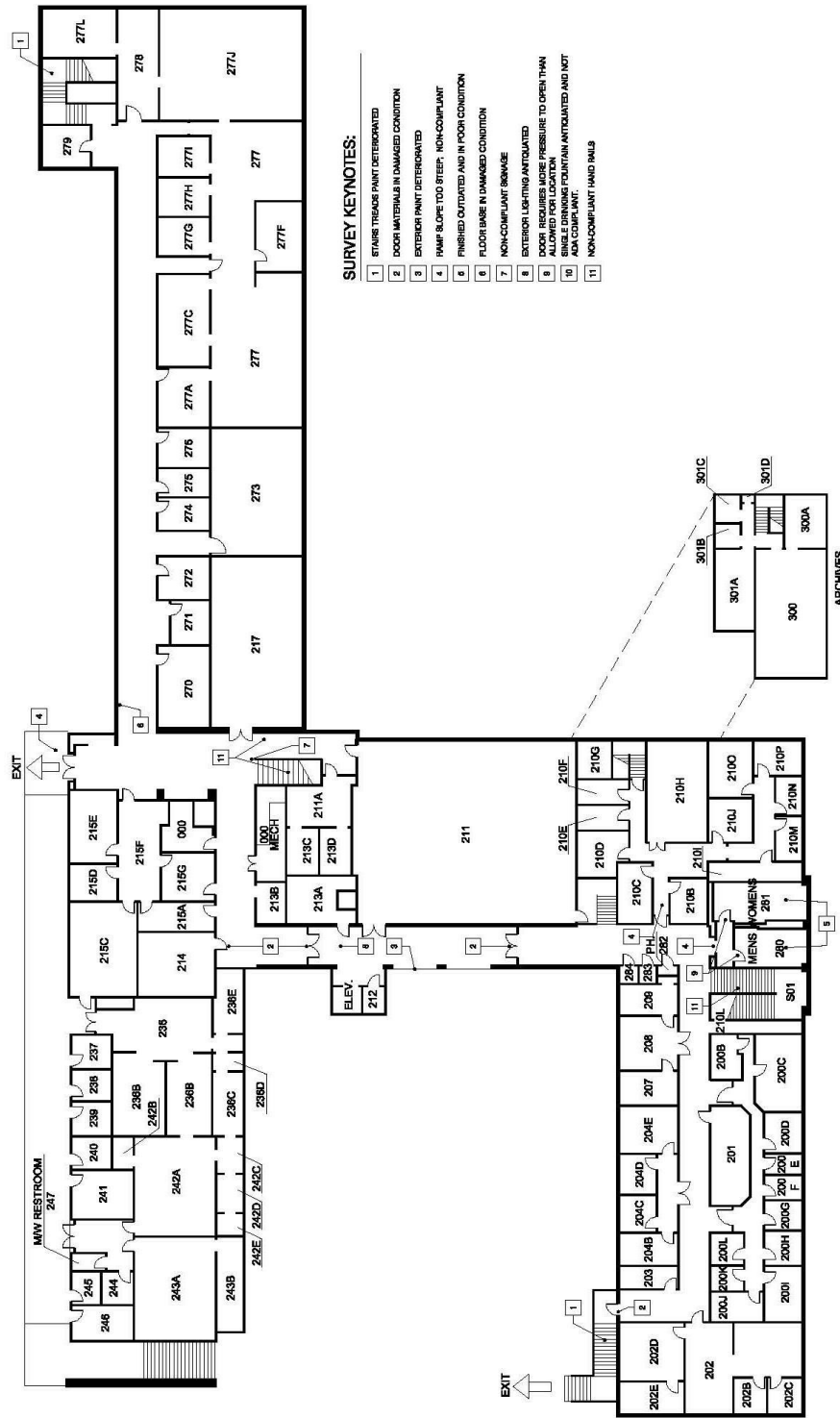

**ADMINISTRATIVE BUILDING 2ND FLOOR PLAN**  
NO SCALE

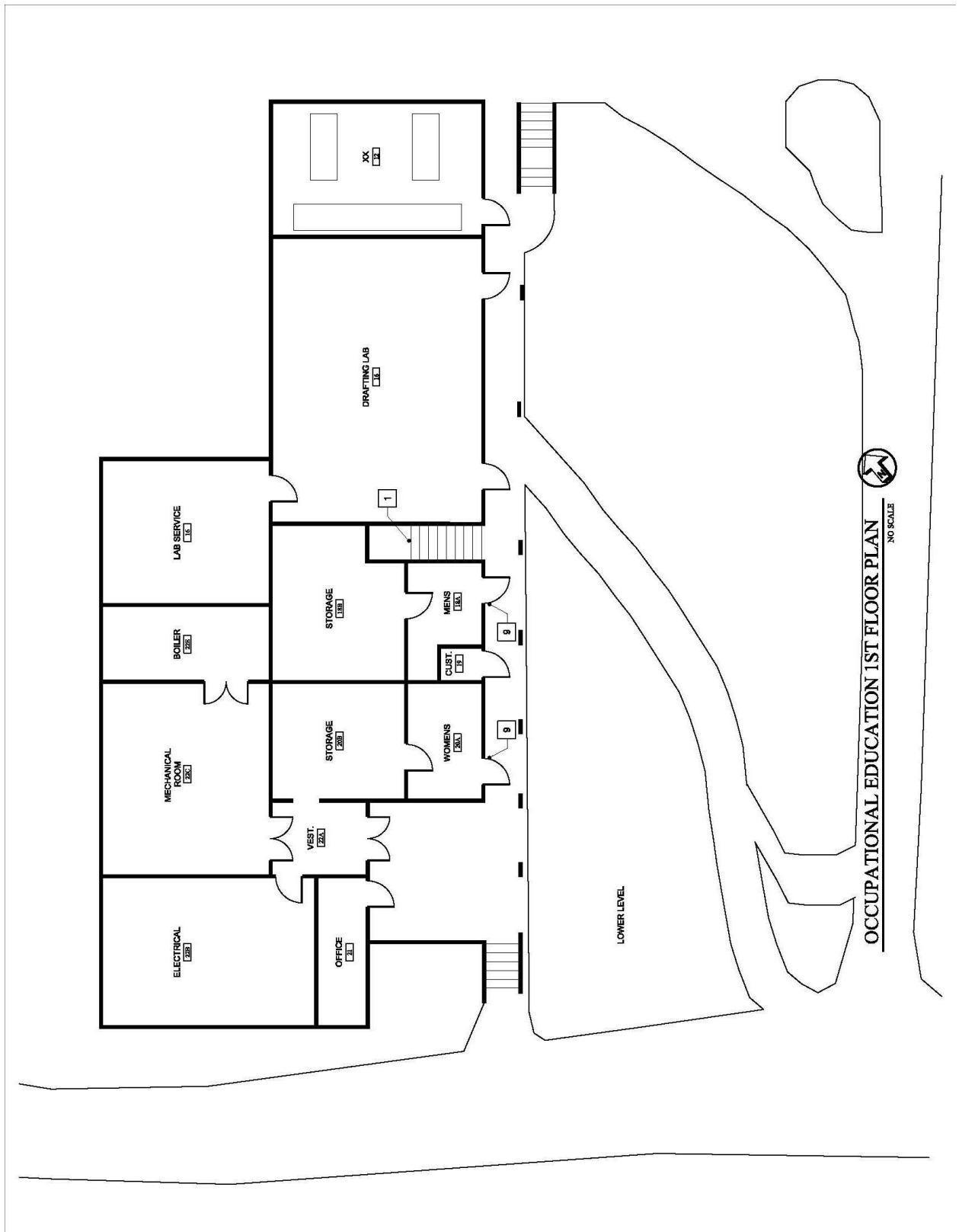

**OCCUPATIONAL EDUCATION 1ST FLOOR PLAN**  
NO SCALE

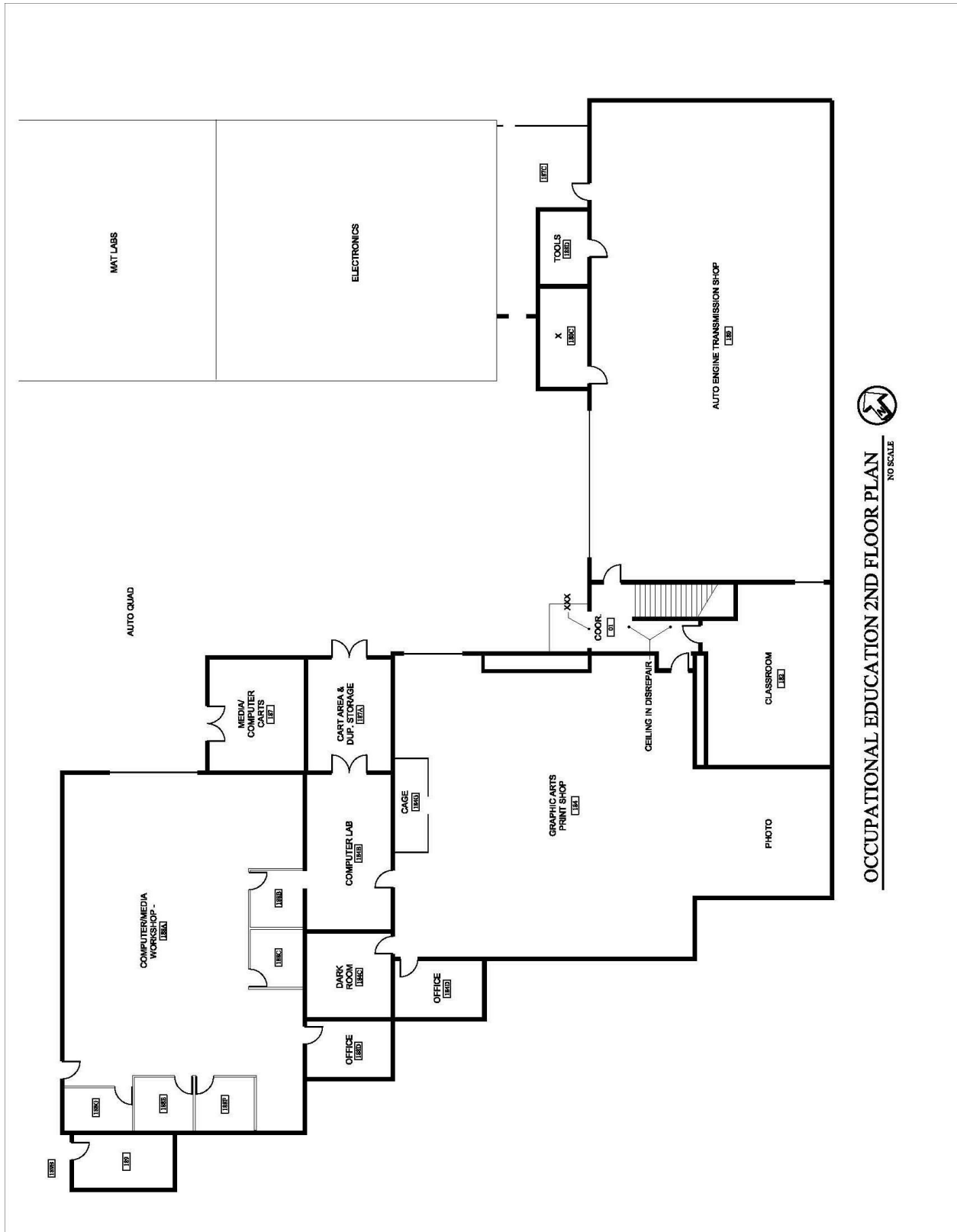

**OCCUPATIONAL EDUCATION 2ND FLOOR PLAN**  
NO SCALE

# APPENDIX B

## PHOTO LOG & NARRATIVE

1. Architectural
  - a. Exterior
    - 1) Wall Finishes
    - 2) Roof Systems
    - 3) Entrances/Doors
    - 4) Windows
    - 5) Floor Finishes
  - b. Interior
    - 1) Wall Finishes
    - 2) Ceiling Systems
    - 3) Doors
    - 4) Floor Finishes
2. Building Systems
  - a. Mechanical
  - b. Electrical
  - c. Plumbing
3. Accessibility
  - a. Restrooms
  - b. Drinking Fountains
  - c. Stairs
  - d. Elevators
  - e. Signage
  - f. Path of Travel



## EXTERIOR

- Wall finishes



AE1. Northeast exterior walkway wall.



AE2. Northeast exterior ramped entrance walkway wall.



AE3. Northeast exterior entrance column.



AE4. Northwest exterior walkway wall.



AE5. OE building, exterior wall facing Auto Quad.



AE6. OE building, southeast exterior overhang.

## EXTERIOR

- Roofs systems



R1. Northeast roof overhang with damaged tiles.



R2. Northeast wing built-up roof.

## EXTERIOR

- Entrances/Doors



D1. First Floor entrance doors near elevator.



D2. Edge Damage at entrance doors.



D3. Painted office door at north east side of building, with non-compliant threshold.



D4. Classroom door at OE build first floor storefront system.

## EXTERIOR

- Windows



EW1. Northwest first floor.



EW2. Southeast facing Auto Quad.



EW3. Southeast facing Auto Quad.



EW4. Southeast wing second floor corridor.



EW5. Second floor Women's restroom.

## EXTERIOR

- Floor Finishes



EF1. Northwest exterior corridor.



EF2. Northwest entrance to Elevator.





EF3. Southeast OE exterior corridor.



EF4. Southeast OE upper exit to Auto Quad.

## INTERIOR

- Wall Finishes



AI1. Interior corridor corner.



AI2. Second floor southeast interior corridor building joint.



A13. First floor Men's Restroom.



A14. Building joints.

## INTERIOR

- Ceiling Systems



C1. First floor Women's Restroom.



C2. OE stairway ceiling.



C3. OE second floor corridor.



C4. Southeast corridor ceiling at offices.

## INTERIOR

- Entrances/Doors



D1. Second floor equipment room doors.



D2. 2nd floor exit door to stairs.



D3. Entry door to 1st floor Duplicating.



D4. Office door 2nd floor Health Occupations.

## INTERIOR

- Floor Finishes



IF1. Southeast corridor.



IF2. Southwest corridor 210.



IF3. Southwest corridor second floor.



IF4. OE corridor second floor.



## Building Systems

- Mechanical

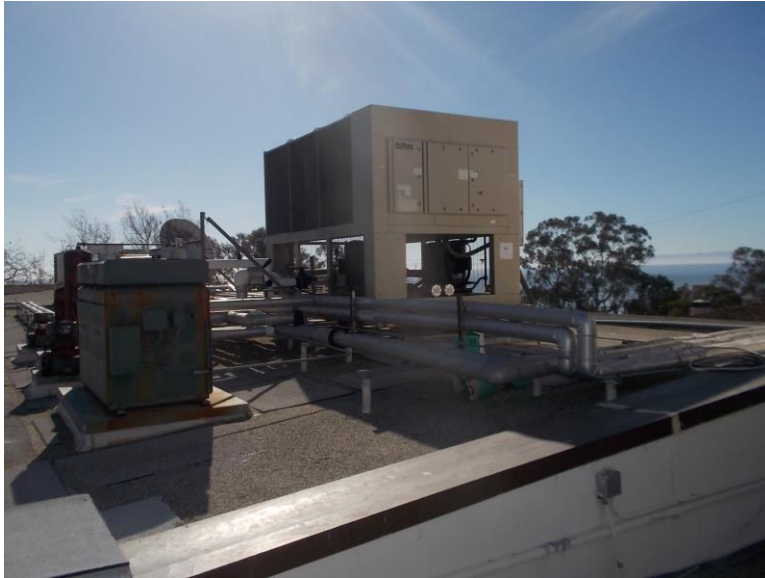

M1. Rooftop mechanical equipment.



M2. Rooftop mechanical equipment.



M2. AHU in basement.



M4. Split heat pump systems for air conditioning offices.

## Building Systems

- Electrical



E1. 2006 New generator behind east side of the building.



E2. Switchgear in basement.



E3. Access to Electrical equipment in basement.



E4. Exposed wiring in j-box.



E5. Exterior lighting at northeast stairs.



E6. Exterior lighting with surface mounded conduit by elevator.

## Building Systems

- Plumbing



P1. Boiler in basement.



P2. Boiler piping in basement.

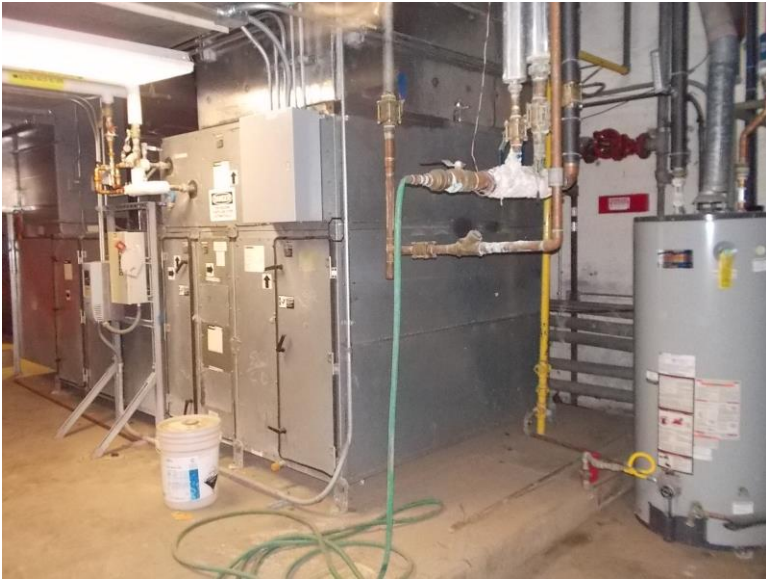

P3. Water heater in basement.



P4. Unisex –non-compliant toilet fixture, second floor northeast wing.

## ACCESSIBILITY

- Restrooms



RR1. Womens non-compliant restroom, first floor northwest wing.



RR2. Womens non-compliant restroom, first floor northwest wing.





RR3. Mens restroom, first floor southwest wing.



RR4. Womens restroom, second floor southwest wing.

## ACCESSIBILITY

- Drinking Fountains



DF1. Charming era non-compliant drinking Fountain at first floor entry.



DF1. Second floor drinking fountain at restrooms.



DF3. Compliant DF at second floor SE wing.



DF4. Non-compliant DF at OE first floor.

## ACCESSIBILITY

- Stairs



S1. Exterior stairs with non-compliant nosings.



S2. Exterior stairs with non-compliant nosings and handrails.



S3. Exterior stairs to OE with non-compliant handrails.



S4. Exterior stairs with non-compliant handrails, and no level landing.

## ACCESSIBILITY

- Elevators



EV1. Elevator as central ADA access.



EV2. Elevator car interior.

# ACCESSIBILITY

- Signage

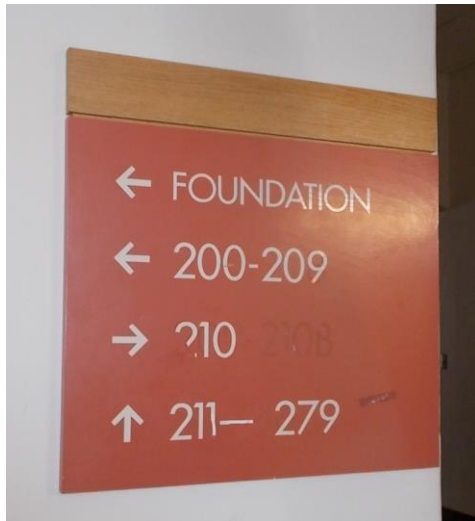

S1. Directory Signage – second floor.

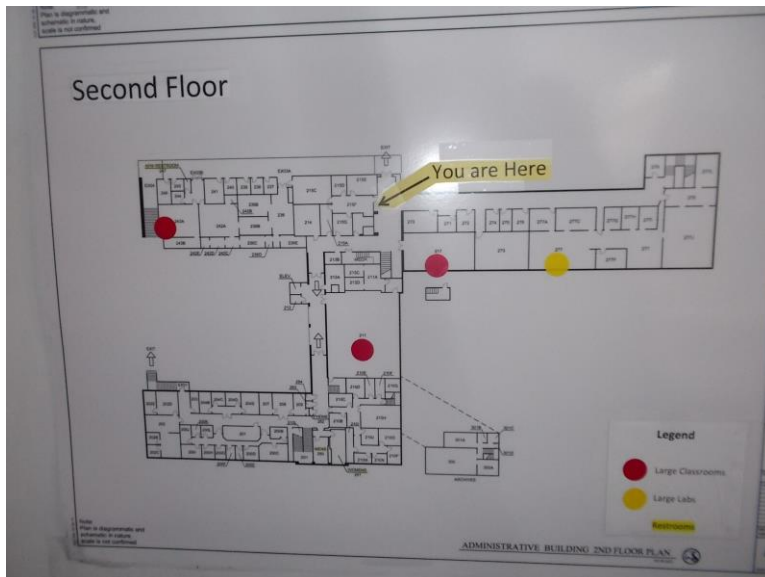

S2. Evacuation Signage – second floor.



S3. Room ID signage – second floor.



S4. Non-compliant RR signage – 2nd floor.



S5. Non-compliant RR signage – 2nd floor.



S6. Exterior wayfinding signage.

## ACCESSIBILITY

- Path of travel



PT1. Non-compliant stairs at West main entry.



PT2. Non-compliant transition at East ramped entry.





PT3. Non-compliant transition at East ramped entry.



PT4. Non-compliant curb ramp at OE Auto Quad entry.

**APPENDIX C  
EXISTING BUILDING  
DETAILS**

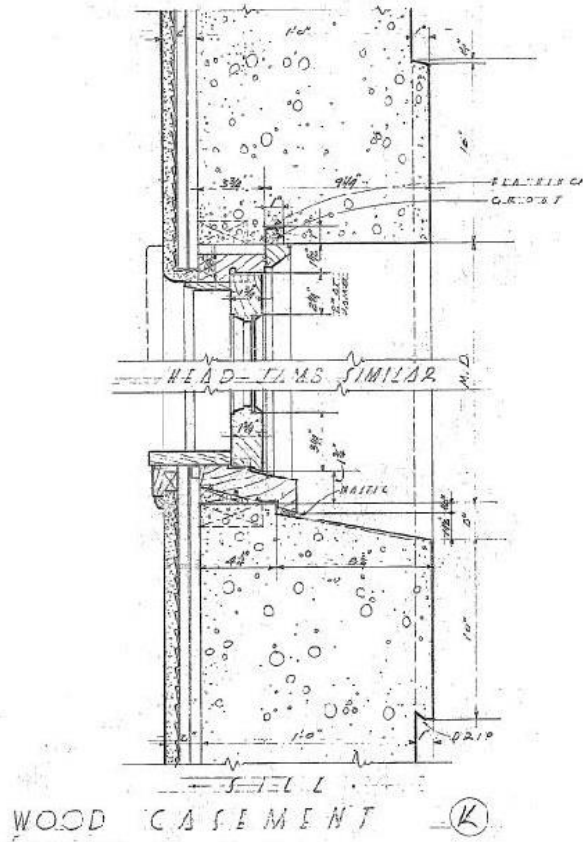
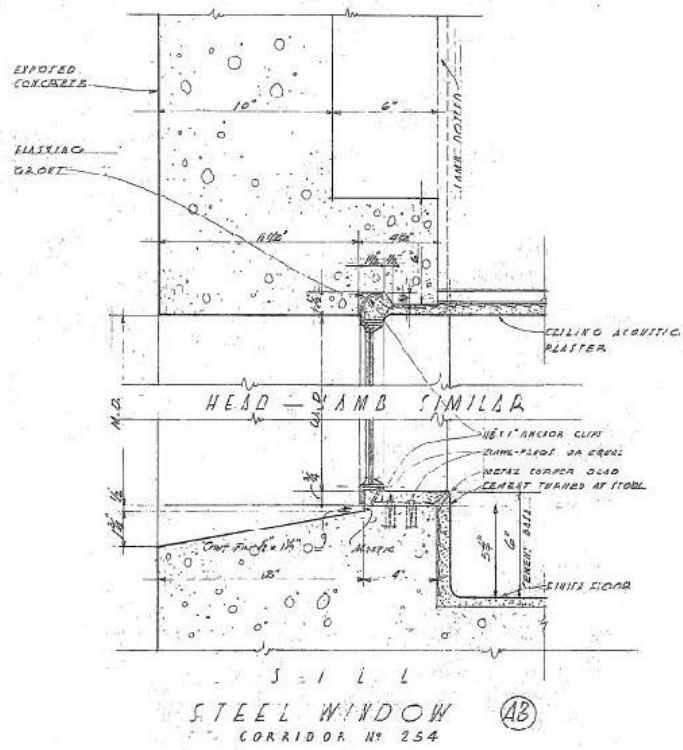

# **Facility Condition Assessment Report** **BUSINESS/COMMUNICATIONS CENTER**

*Prepared for*



**SANTA BARBARA CITY COLLEGE**

**Santa Barbara City College – Main Campus  
721 Cliff Drive  
Santa Barbara, CA 93109**

RJC Project No: 2015.46



*Prepared by*  
**RJC Inc**

**Facility Condition Assessment Report**  
**Santa Barbara City College – Main Campus**  
**Business/Communications Center**  
**721 Cliff Drive**  
**Santa Barbara, CA 93109**

March 04, 2016

---

---

*TABLE OF CONTENTS*

*Description*

<i><u>Number</u></i>	<i><u>Page</u></i>
1. Facility Description	2
2. Major Findings	3
3. Site Findings	4
4. Architectural Findings	5
5. Mechanical Findings	6
6. Electrical Findings	7
7. ADA Building Descriptive Report	8
8. Inspectors Notes	9
9. Summary	9

*Appendix*

A. Building Plans	10
a. First Floor	11
b. Second Floor	12
c. Third Floor	13
B. Photo Log and Narrative	14-53
C. Existing Building Details	54-56

# **1. Facility Description**

Year Built: 1991-93

Floor Area: 32,456 square feet

Construction type: Type II-N, sprinkled

Occupancy: Mixed, B-2 (offices and education), A-3 (assembly)

The Business Communications building is a 3 story structure on the West Campus, adjacent the parking structure, sits on a sloping site, and houses offices, classrooms, meeting rooms, library, lounge and reception areas. The building was built in 1991, with concrete slab on grade, concrete cast in place and CMU walls, steel stud walls with batt insulation, and steel structural columns. Metal stud interior wall framing is utilized throughout, with poured concrete over metal deck floors. The exterior walls have a painted plaster finish with ceramic tile decorative accents, precast concrete wainscots, and the upper level terraces have glass wind screens. The exterior sidewalks are broom finished colored concrete. The roof system is a combination of membrane roofing with tapered insulation over metal decking, and Mission clay tile with underlayment over rigid insulation and metal decking, plaster covered parapets and includes two aluminum framed acrylic skylights. A clock tower sits approximately 23 feet above the roofline at the north side of building. Half round copper gutters and downspouts flow rainwater to subsurface perforated drainage pipes. Vertical circulation elements include an interior elevator, and interior and exterior stairways. Exterior entry stairs have precast concrete risers and treads with ceramic tile warnings strips.

The interior spaces have suspended acoustic tile and veneer plaster ceiling systems, as well as wood grid ceiling panels. Wall types include glass block and exposed CMU, with finishes consisting of fabric covered wainscots, painted gypsum board, veneer plaster, porcelain tile, etched metal and oak wall panels. Floor finishes include carpet, resilient, ceramic mosaic, and quarry tile flooring, with rubber cove, ceramic and oak wall bases. Interior spaces incorporate plastic laminate and wood casework, built-in file cabinets, marker boards, and fabric covered tack boards. The interior doors are a combination of painted steel and solid core with plastic laminate, grooved aluminum plank and wood paneling finishes. Some doors have flush vision panels. Exterior entry doors are prefinished aluminum storefront systems with glazing.

The exterior windows are both operable and fixed, with aluminum and steel frames. Upper level windows are shaded with exterior cement plaster sunshades, while other windows utilize interior draperies or roller shades.

All floors of the building have both men's and women's accessible restrooms in addition to water fountains. The restrooms have the original ceramic floor and wall tile, plumbing fixtures, ceilings and lighting.

The area around the building is both paved and landscaped, offering several locations in which to enter the building with a mixture of sloped walks, ramps, and stairs.

The building is both sprinklered and furnished with fire alarm devices connected to the campus wide fire alarm system. All levels have fire extinguishers spaced appropriately, and each exit door is properly accented with illuminated exit signs, and fire alarm pull stations.

## **2. Major Findings**

The building has not had a comprehensive renovation since its original construction in the mid 1990's, and although the finishes and colors were well-suited to that era, they are now dated, and do not relate well with other campus buildings. The interior wall, floor and door finishes, casework, instructional equipment and utilities are outdated, deteriorating, and some spaces have a variety of ADA compliance issues.

The following are major findings discovered during the assessment:

- Ceiling systems - The suspended ceiling system is original and in fair to poor condition. There are multiple locations throughout the building where the acoustical ceiling tiles are damaged and stained, and the suspension grid system is bent. Additionally, the suspended ceiling system components such as: suspension hanger and bracing wire types and attachments, compression posts, main and cross runners, splices, expansion devices, intersection connectors, fire rating, and total system weight, likely no longer meet current ASTM ratings, the CBC, nor Department of the State Architect (DSA) requirements.
- Flooring - Although the color and style of the quarry tile is dated and dirty, it remains in good condition. The original carpet throughout the building is dirty, stained, worn, and in dire need of replacement. Resilient flooring coved base and wood base both show signs of wear and damage.
- Walls - The building supports a wide variety of wall materials and colors, most of which are in poor condition. The finish materials are tattered, damaged, stained, and require repainting and/or refurbishing.
- Doors - The color of the plastic laminate finish on the doors vary throughout the building; many show wear, are stained, and the edges of the laminate are damaged and chipped. Reskinning these doors would benefit the overall life span of the space.
- Restrooms - There are student restrooms on both the first and second floors, and one unisex staff restroom on the second floor. All floor finishes, colors, fixtures and equipment of are in fair condition. ADA restroom door signs are non-compliant with current codes. Although the layouts and configurations are efficient, these restrooms were originally designed to meet earlier ADA standards, and should be re-evaluated for compliance to current ADA codes. The staff restroom on the second floor is non-compliant due to dimensional clearance deficiencies.
- Drinking Fountains - The building has one high-low drinking fountain and two single drinking fountains. The building does not the 50% ratio code requirement of hi-low accessible drinking fountains.
- Life Safety Systems - The fire alarm system was upgraded and certified by the Department of the State Architect (DSA) in 2015 and requires no further work.
- Roofing - The built-up roofing is in good condition. The Mission clay roof tile is in overall good condition, but it is unknown if the roof tile tie-down system meets current Department of the State Architect (DSA) requirements.

### **3. Site Findings**

The building sits on a sloping site, creating both, ramped, sloped and staircase entrances at each side of the building.

The outdoor entry plaza on the east side provides access to the main building lobby, the Fe' Bland Forum, and the Forum box office. This outdoor space has a ramp, stairs, concrete bench, colored concrete and quarry tile walking surfaces, and ceramic tile detailed stair nosings. The plaza finishes are degraded, uneven and worn, with abrupt changes in level. The six tall palms have open tree wells with exposed dirt and old up lights, and are without tree grates. These tree wells have a thin metal trim which rises above the adjacent sidewalk, creating tripping hazards. A tree grate system should be installed to provide a safe extension of the pedestrian walk way.

The main entrance on the west side of the building is accessed by both a wheelchair ramp and stairs. The intermediate landing on this ramp exceeds the 2% allowed maximum cross slope. The north and east sides of the building are surrounded by stairs, and do not offer any ramped accessible entrances.

All exterior ramp and stair handrails around the building site have non-compliant returns, and all are shorter than the current 34" minimum height code requirement.

Exterior circulation around the building is upon both asphalt and concrete paving. At multiple locations along the presumed accessible path of travel, cross slopes exceed the maximum 2% allowed, longitudinal slopes exceed the maximum 5% allowed and are without handrails. There are various points along this path of travel that have abrupt changes in level and hazardous surface features.

The sloped sidewalk approach on the east side of the building also has excessive cross and longitudinal slopes, is interrupted by a drainage grate, and leads to an entry with stairs. No signage exists to indicate this entry is not intended for wheelchair use. The adjacent exterior stair to the third floor does not provide a level lower landing, nor the 36" minimum length in the direction of travel. The finishes in this area are stained, worn and aging.

The south side stairs and wheelchair ramp are missing handrails, and a drainage grate creates an abrupt and non-level landing at the bottom of the ramp.

The café/snack bar outdoor seating area is accessed by excessive sloped paths, degraded and uneven asphalt to concrete transitions with abrupt changes in level, and hazardous surface features.

The paved paths of travel from the adjacent accessible parking spaces are not ADA compliant. The paths from both parking lot 4D and 5 have excessive cross and longitudinal slopes, and parking lot stairs do not have detectable warning pavers at the flush vehicular influences. The immediate surrounding site is severely lacking exterior path-of-travel and wayfinding signage as required by code.



## ***4. Architectural Findings***

The following architectural items were discovered during the assessment:

**ROOF:** The built-up roof system and clay roof tile are in good condition.

**CEILINGS:** The ceilings in the facility are the original suspended acoustic tile and plaster ceiling systems. Many lay-in tegular ceiling tiles are stained, damaged, require replacement, and at various locations grid members are bent and require refurbishment. The suspended ceiling system may no longer meet current code requirements and regulations, has not been upgraded, and would greatly benefit from refurbishing.

**WALLS:** The exterior wall finish is painted plaster over both concrete and steel stud construction, and at numerous locations, is in very poor condition. The finish is bubbled, peeling, has below surface plaster deterioration, and is in dire need of repair.

Interior walls are both painted gypsum board, veneer plaster, and painted concrete. The spaces are a variety of colors, not the College's standard 'Cottage White' color, adding to ongoing maintenance issues. Numerous walls, wall corners and wall finishes throughout the building are damaged and need repair. The classrooms wall finishes are in very poor condition, with peeling paint, exposed putty filled holes, and various permanent stains. Additionally, the classrooms have fabric covered tack boards with stained surfaces, requiring replacement of the fabric. The second floor office area has fabric covered walls, with wood base. These fabric wallcoverings are badly stained, damaged, vandalized, and are in need of replacement with a more durable material.

**FLOORING:** Although the colors are dated, the quarry tile flooring in the corridors and entry areas is generally in good condition, while the carpet throughout the facility is in poor condition and in need of replacement. Rooms with resilient flooring have localized areas of wear and damage, and would benefit from replacement as well.

**RESTROOMS:** The finishes and fixtures are in fair condition, but the layouts require reconfiguration to meet current accessibility codes for dimensional clearances.

## **5. Mechanical Findings**

The mechanical system consists of one chiller, one boiler and eight Air Handler Units (AHUs). There are six roof mounted AHUs, and one AHU in Room 144 which serves the Cafe Kitchen and one in Room 232 serving the Forum. This is four pipe hydronic heating and cooling system with gas fired boiler and air cooled chiller.

The gas fired boiler is located in Room 232. The chiller is in an enclosure adjacent the southeast side of the building and is a Trane 70 ton air cooled chiller, installed in 2015, and in good condition. Six AHUs are located on the roof. All other AHUs are located in mechanical rooms thorough out the building.

The boiler, chiller, and six rooftop AHUs were replaced in 2015, and the piping, piping insulation, pumps, valving, controls and accessories appear to be new and in good condition. Although some of the aluminum pipe insulation protectors serving the rooftop AHUs has been damaged from foot traffic, and requires replacement and protection from further damage.

Two AHUs serving the Cafe Kitchen and Forum appear to be original, are at the end of their useful life, and should be replaced. The equipment belts, filters and motors are a regular, ongoing maintenance issue.

There are twenty-one original fan coils with replaced piping, piping insulation, valving, controls and accessories. They are in proper working order.

Some exhaust fans are original and some have been replaced on an as needed basis.

There are debris and storage items blocking the minimum clear working space around all mechanical indoor equipment.

All equipment was properly marked. Rooftop units, piping and curbs meet minimum clearances, supports are secured to the structure, properly seismically restrained, and vibration isolation is present. The disconnecting means are present, in good working order and are in-site and readily accessible. Exterior ducts are protected by a weatherproof barriers, and duct smoke detectors were present. The outside air intake vent distances and air inlet screen protection are in place. The exhaust discharge clearances to walls, roofs, operable openings and grade are within code requirements. Rooftop condensate lines discharge flows to drains connected to sewer system. Refrigerant pipe and tubing are compliant and refrigerant detectors are present. Boiler shutoff valves are present in the supply/return piping. Pipe hangers/anchors/supports are within proper spacing.

## **6. Electrical Findings**

The main electrical switchgear and transformer are located in Room 232. Both are original; the switchgear appears in good condition, yet the transformer has reached the end its useful life and should be replaced. There are indoor substations located throughout the building. Around the main switch there are debris and storage items blocking the minimum clear working space.

Service Disconnecting Means are present, in good working order, are in-site and but are not readily accessible as there are debris and storage items blocking the minimum clear working space in front of electric equipment. Ground Fault Protection and grounding electrodes are present and appear in good working order. Electrical panels have circuit directories, but it is unknown if the directories are up to date. Energy efficient lighting for interior and exterior are being upgraded on an on-going basis. Life-safety elements and emergency lighting are present. Adequate illumination of interior and exterior spaces appears to be present, but indoor and outdoor lighting fixtures are older, and may no longer meet current Title 24 code requirements.

## **7. ADA Building Descriptive Report**

The main building entry at the west side of the building is intended to be the wheelchair accessible entrance, but lacks a compliant access ramp, and no ADA signage is present to indicate accessibility, such as an International Symbol of Accessibility (ISA) symbol.

Due to the sloping site conditions, there are multiple doors leading to the exterior of the building. Electronic door operators are adjacent many of these exterior doors, but lack the lower access button required by current code.

Once inside the building, the corridor widths are compliant, most doors offer adequate dimensional push/pull side clearances, and an elevator provides access to all floors.

A few doors do not meet all ADA requirements such as: southeast office entry door thresholds exceed the 1/2" maximum height, the entry door to Room 249A does not provide adequate dimensional side clearances, and the pair of fire doors at the top of the third floor stairs impede into the clear space of the upper landing.

Exit doors are marked with the proper illuminated signage, allow ample dimensional push and pull maneuvering clearances and the door opening forces are within the allowable ranges.

Although the building does have updated compliant interior room identification signs, it lacks interior directory and wayfinding signs, as well as exterior visual, tactile or Braille door identification signs. The information provided in the fire safety/evacuation maps are missing fire extinguisher and fire alarm pull station locations.

Stairway exiting signage is non-existent at all levels. Tactile identification signs identifying the floor level, stair level and exit level are non-existent. Stairwell doors leading to the exterior do not have ADA tactile exit signs.

There are three drinking fountain locations in the building; one hi-low and two singles. The hi-low fountain adjacent the second floor restroom meets ADA codes, while the first and third floor single fountains do not. The first floor fountain is in an awkward and unapparent location next to the electrical room and elevator doors, does not provide adequate maneuvering clearances, and impedes into the pull side clearance at the adjacent door. Two of the three fountains are required to be hi-low accessible drinking fountains, and therefore the building does not meet the 50% ratio required by code, and accommodations should be provided.

An elevator provides access to all levels, but lacks the proper tactile and Braille floor designations at the jambs of each floor, and has no verbal annunciator to announce the floor at which the car is stopping.

## **8. Inspector's Notes**

The building has not been generally well maintained, but is functional for its intended uses. It is in need of a modernization to be brought up to the level of other college and educational buildings of this type. This building is salvageable and is recommended for modernization versus replacement. A modernization of floors, walls, ceilings, lighting and signage is recommended.

The surrounding site and building entrances are in need of modernization to be brought up to current ADA accessibility codes.

There are debris and storage items blocking the minimum clear working space around all mechanical and electrical indoor equipment. The items should be relocated immediately to increase building safety, eliminate fire hazards, and provide code required minimum clear working spaces.

## **9. Summary**

The existing Business Communications building has not had a major modernization since the building was built 25 years ago. The existing ceiling system, classroom and office flooring, wall and door finishes are dated, extremely worn and damaged, are no longer aesthetically pleasing, and have reached the end of their useful life. The classroom fixtures and furnishings are also damaged and no longer meet the standards of modern instructional spaces. These finishes and fixtures require replacement, and would benefit from a significant modernization to meet the quality and life-cycle of similar educational facilities.

The surrounding exterior circulation route does not provide a compliant path of travel to the main building entrance, nor other ancillary exits. Signage, handrails and walking slopes should be renovated for proper accessibility.

The outdoor plazas and walkway areas have hazardous and abrupt changes in level, deteriorated materials, poorly marked entrances, and dimly lit exteriors. These areas would benefit from site improvement renovations to provide safer circulation, and create more inviting spaces for users to gather.

The two air handler units serving the Cafe Kitchen and Forum are at the end of their useful life, and should be replaced, as well as equipment belts, filters and motors. An overall clean-up of both mechanical and electrical rooms is recommended to remove debris causing hazardous working conditions.

# **APPENDIX A BUILDING PLANS**

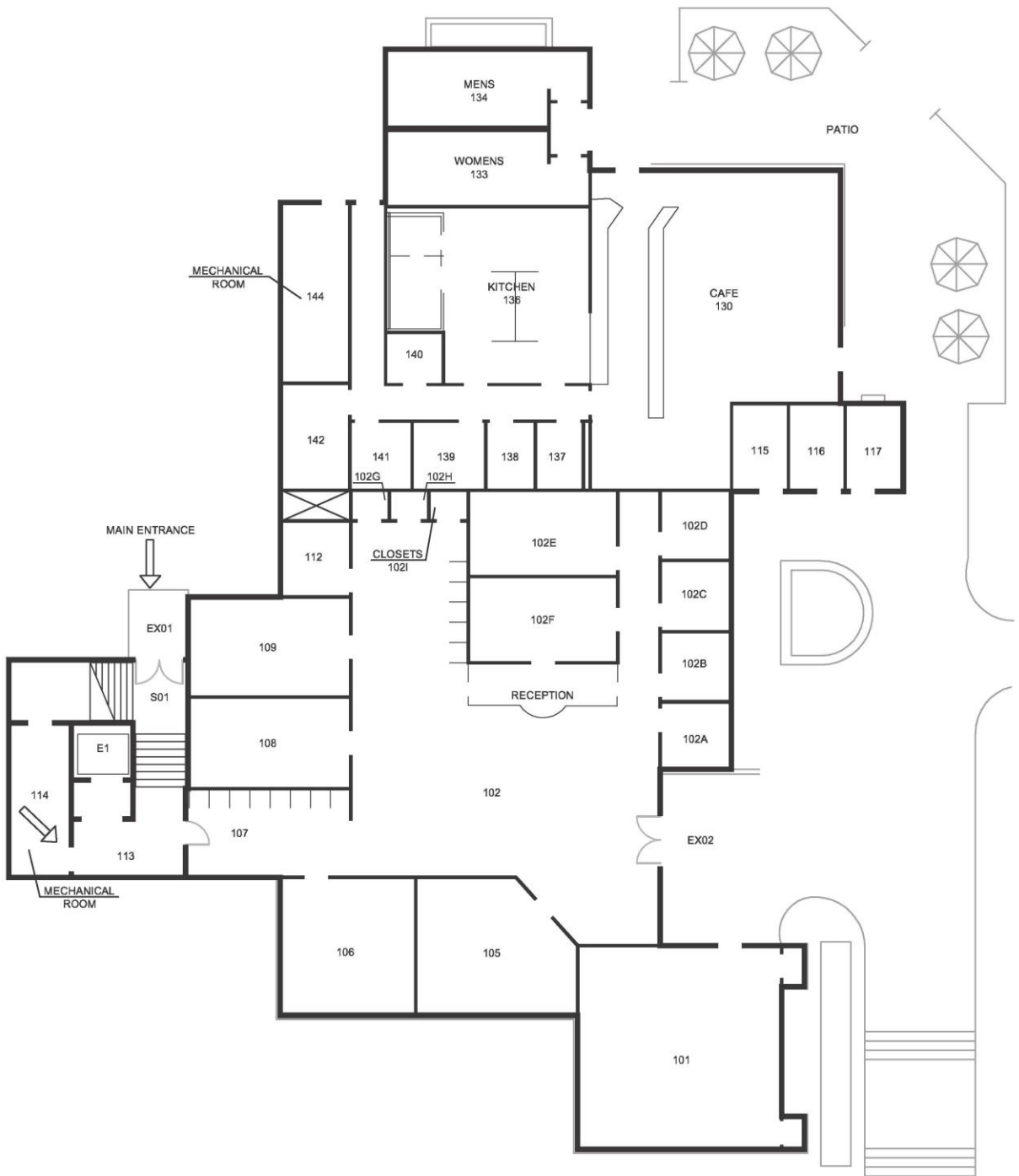

BUSINESS COMMUNICATIONS 1ST FLOOR PLAN

NO SCALE



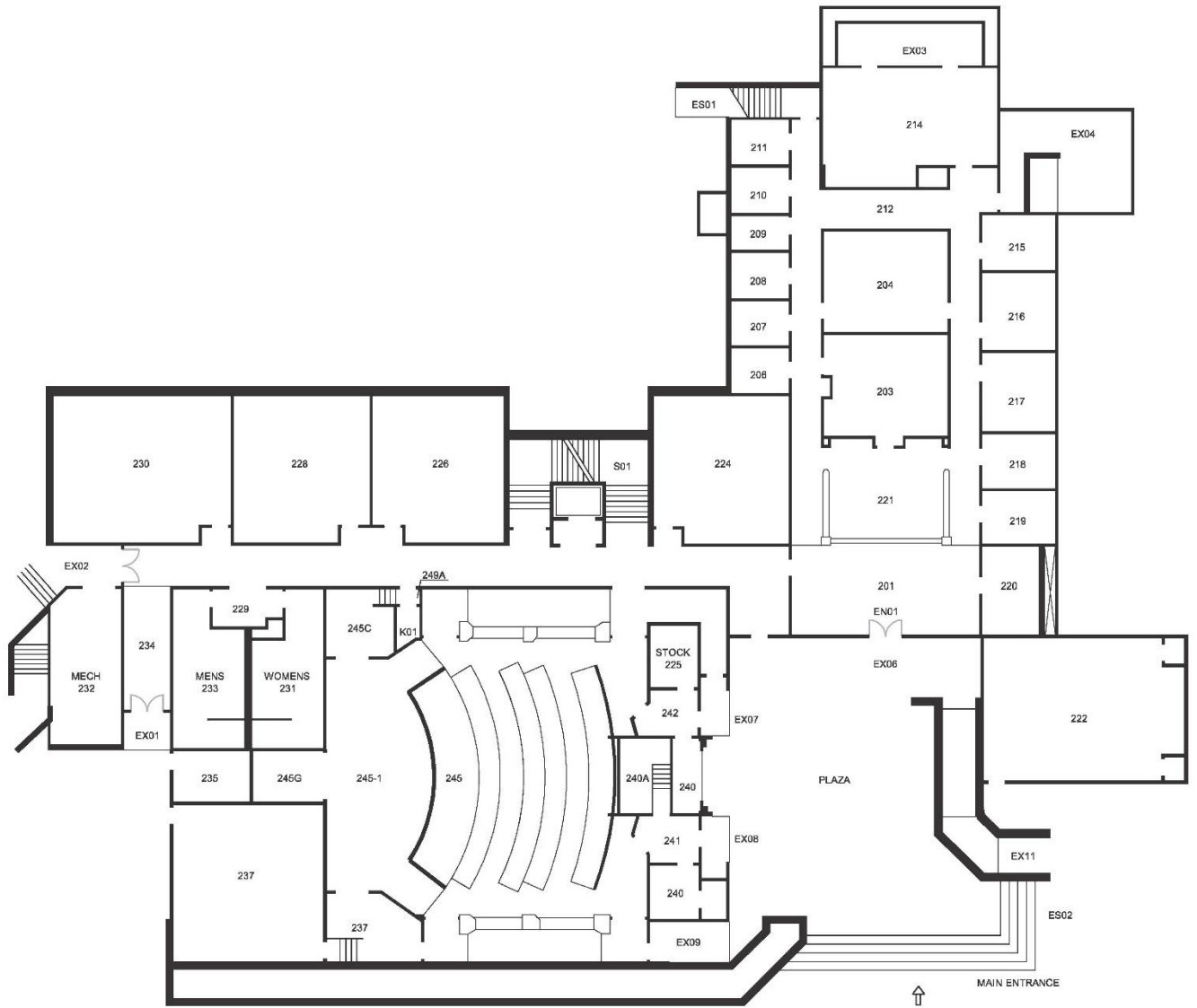

BUSINESS COMMUNICATIONS 2ND FLOOR PLAN   
NO SCALE



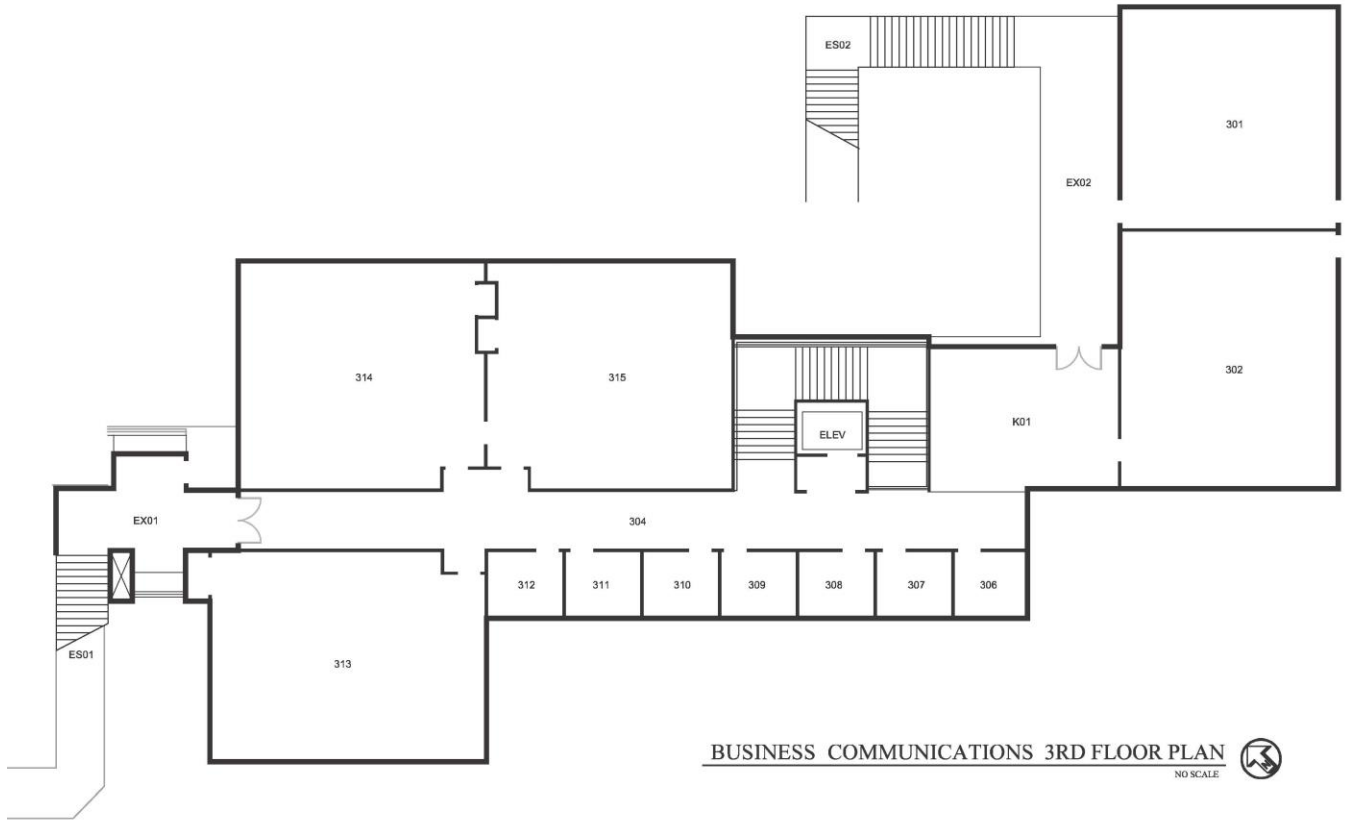

BUSINESS COMMUNICATIONS 3RD FLOOR PLAN  
NO SCALE



# APPENDIX B

## PHOTO LOG and NARRATIVE

1. Architectural
  - a. Exterior
    - 1) Wall Finishes
    - 2) Roof Systems
    - 3) Entrances/Doors
    - 4) Windows
    - 5) Floor Finishes
  - b. Interior
    - 1) Wall Finishes
    - 2) Ceiling Systems
    - 3) Doors
    - 4) Floor Finishes
2. Building Systems
  - a. Mechanical
  - b. Electrical
3. Accessibility
  - a. Restrooms
  - b. Drinking Fountains
  - c. Stairs
  - d. Elevators
  - e. Signage
  - f. Path of Travel

## EXTERIOR

- Wall finishes



AE1. Exterior wall with paint damage.



AE2. East exterior wall with bubbling paint.



AE3. Exterior east staircase with paint damage.



AE4. Exterior east staircase with peeling paint.



AE5. Cracked concrete wall at exterior stair.



AE6. Forum ticket booth exterior ceramic tile finish.

## EXTERIOR

- Roofs Systems



R1. Skylight at built-up roof system, in good to excellent condition.



R2. Mission clay original roof tile.



R3. Built up roof with plaster parapet.



R4. Clock tower at plaster parapet.

## EXTERIOR

- Entrances/Doors



D1. Main entry; lacking wall mounted room ID signage, and an ISA symbol.



D2. Second floor entry, door lacking wall mounted room ID signage.



D3. Second floor entry Room 222; lacking wall mounted room ID signage, and pull-side clearance.



D4. Third floor entry; doors lacking wall mounted room ID signage.





D5. Forum door; non-compliant pull-side clearance, and lacking code required door ID signage.

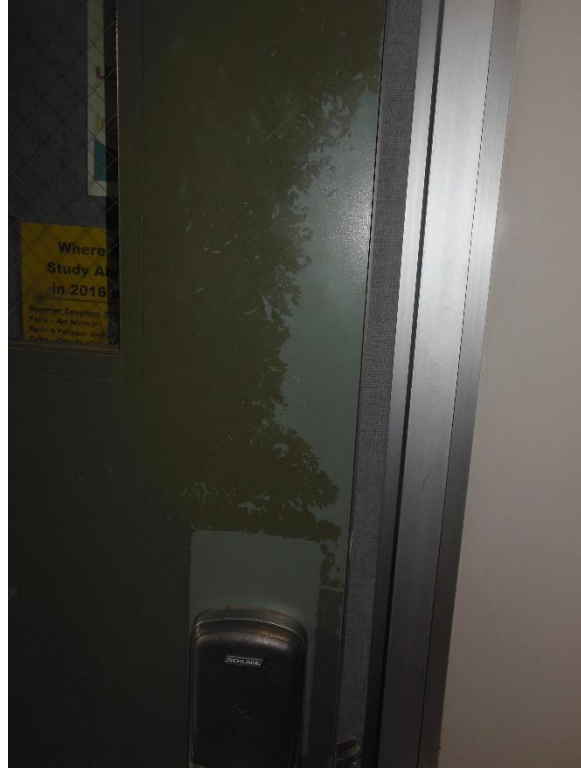

D6. Exterior classroom door; paint finish damaged.



D5. Café restroom doors are missing wall mounted room ID signage. Low level access button for electronic door operator is required by code.



## EXTERIOR

- Windows



EW1. Aluminum framed lower floor windows and sill in good condition.



EW2. Aluminum framed lower and upper floor windows in good condition.

## EXTERIOR

- Floor Finishes



EF1. Colored concrete walkway with cracks.



EF2. Front entry plaza stairs; concrete cracks and tile missing.



EF3. Third floor exterior concrete pavers and concrete stained finish.



EF4. Third floor exterior walkway; concrete pavers stained.

## INTERIOR

- Wall finishes



A1. Second floor corridor; veneer plaster wall stained and damaged.



A2. Second floor corridor; veneer plaster corner damaged.



A3. Second floor Corridor 205; fabric covered wainscot stained and damaged.

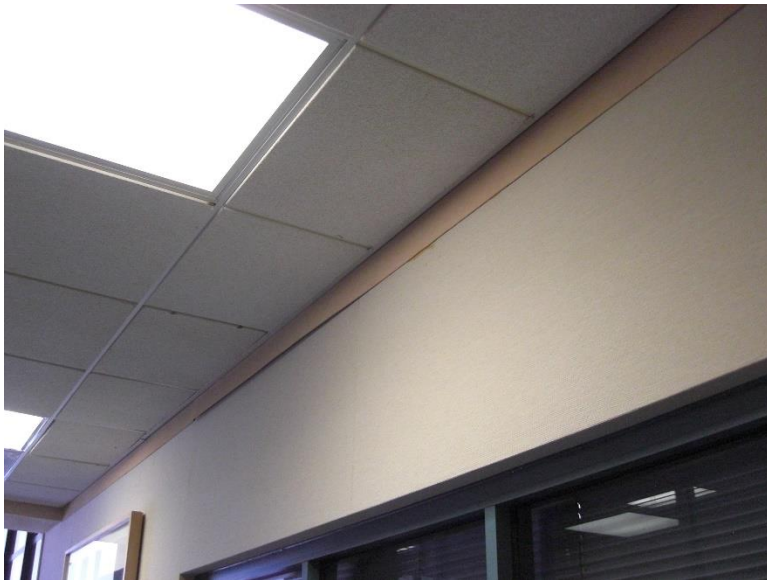

A4. Second floor Corridor 205; head trim piece delaminating from wall.



A5. Second floor classroom; wall repair damage.



A6. Second floor classroom; wall repair damage.



A6. Second floor classroom; paint finish damage from chair backs.



A7. Second floor classroom; wall and paint damage.



## INTERIOR

- Ceilings Systems



C1. Second floor classroom; stained ceiling tile.



C2. Second floor classroom, stained and damaged ceiling tiles.



C3. Second floor corridor; damaged ceiling tiles.



C4. Third floor corridor; damaged ceiling tiles.

## INTERIOR

- Doors



D1. Second floor; damaged and stained plastic laminate faced classroom doors.



D3. Third floor; damaged and stained plastic laminate faced office door.



D4. Exit door from Forum lecture hall foyer. Tactile exit sign missing.



D5. Second floor corridor exit door. Tactile exit sign missing, and exit sign not illuminated.



D6. Third floor, doors impede upper landing clearance.



D7. Second floor staff unisex restroom. Missing wall mounted room ID signage.



D7. Second floor restroom doors are missing wall mounted room ID signage. Low level access button for electronic door operator is required by code.



D8. Second floor corridor exit doors; missing wall mounted ADA exit signage and overhead exit signs are not illuminated.

## INTERIOR

- Floor Finishes



IF1. Second floor reception; wood base damage.



IF2. Second floor Workroom, damaged resilient floor.

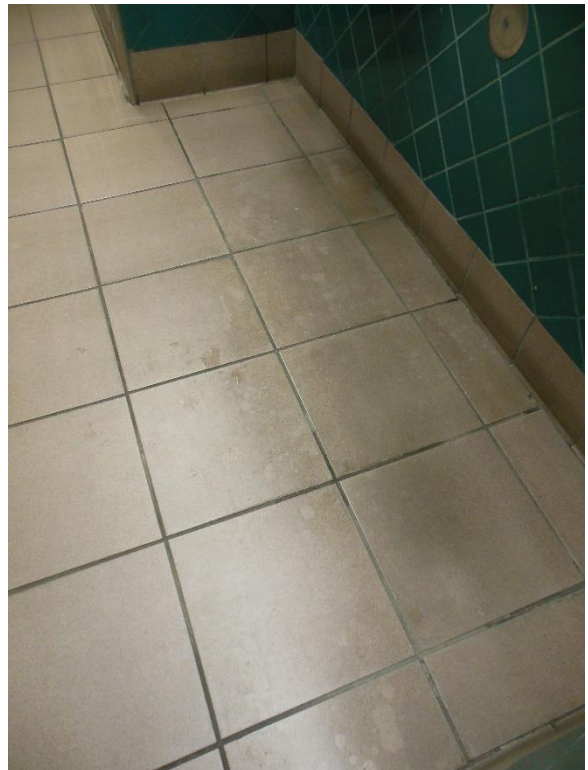

IF3. Second floor corridor, stained quarry tile under drinking fountains.



IF4. Second floor classroom, worn and stained carpet, typical.

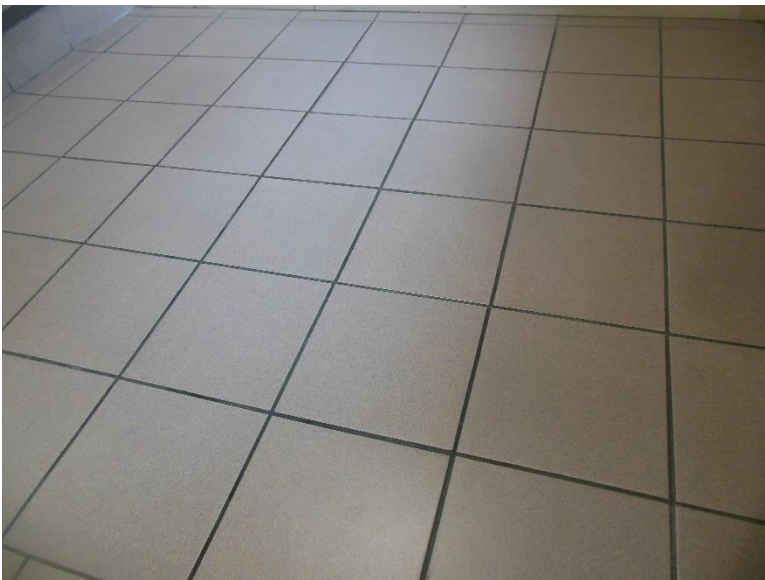

IF5. Interior quarry tile, in good condition.

## BUILDING SYSTEMS

- Mechanical



M1. Rooftop mechanical equipment.



M2. Rooftop mechanical piping damaged.



## BUILDING SYSTEMS

- Electrical



E1. Electrical switchgear.



E2. Electrical equipment lacking clear floor space required by code.

## ACCESSIBILITY

- Restrooms



RR1. Second floor restrooms; improper placement of seat cover dispenser.

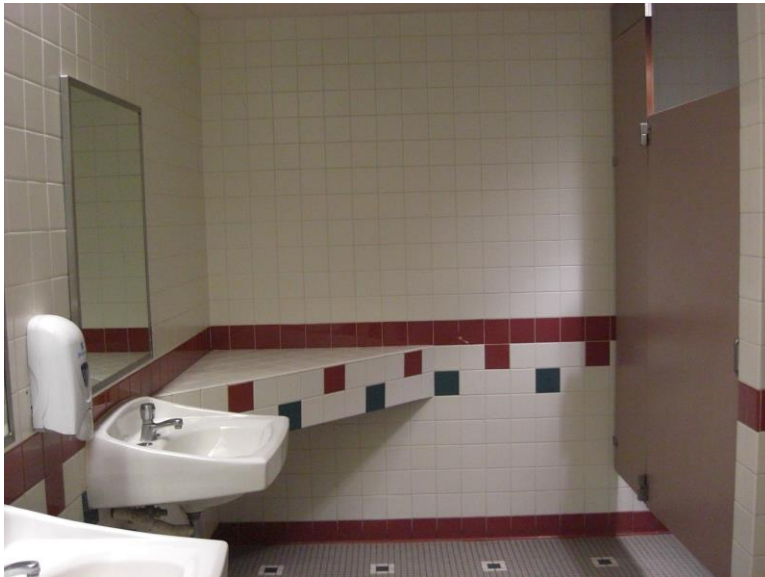

RR2. Second floor restrooms; corner shelf prohibits ADA required door clearances.



RR3. Second floor restrooms; knee protection is not provided at under sink plumbing trap.



RR4. Cafe restrooms; dispensers may impede forward clear space at accessible stall.

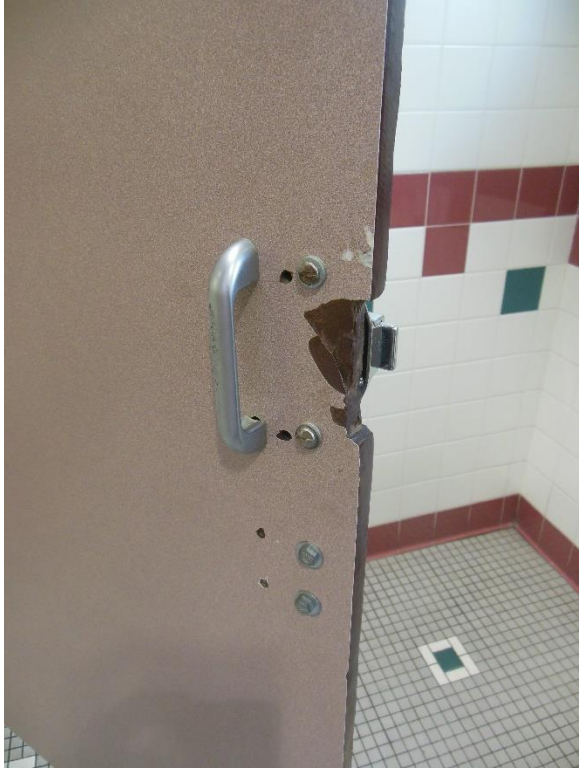

RR5. Café restrooms; damaged accessible stall hardware.



RR6. Café restrooms; damaged accessible stall hardware.

## ACCESSIBILITY

- Drinking Fountains



DF1. Second floor; hi-low drinking fountains.



DF2. Third floor; single drinking fountain.



DF3. First floor single drinking fountain; maneuvering clearances not provided.

## ACCESSIBILITY

- Stairs



ST1. Exterior north stairs; missing required handrails.



ST2. Exterior south stairs; missing required handrails.

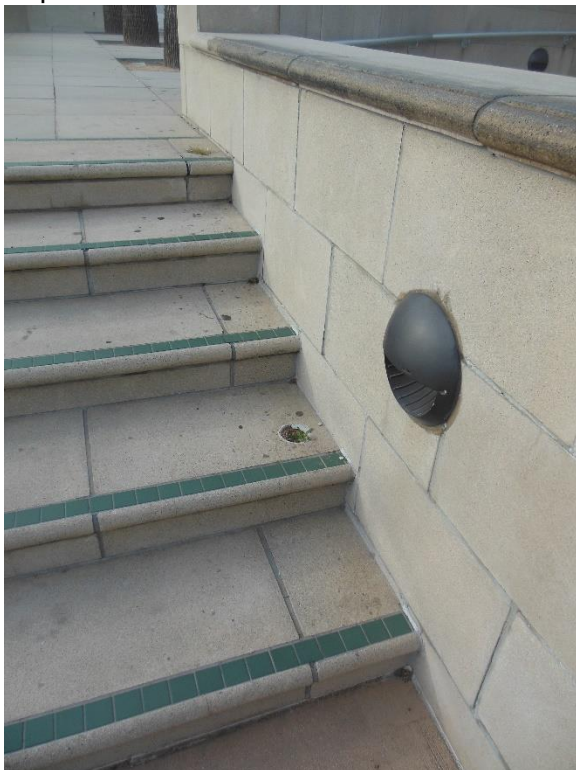

ST3. Front entry plaza stairs; handrail removed/missing.

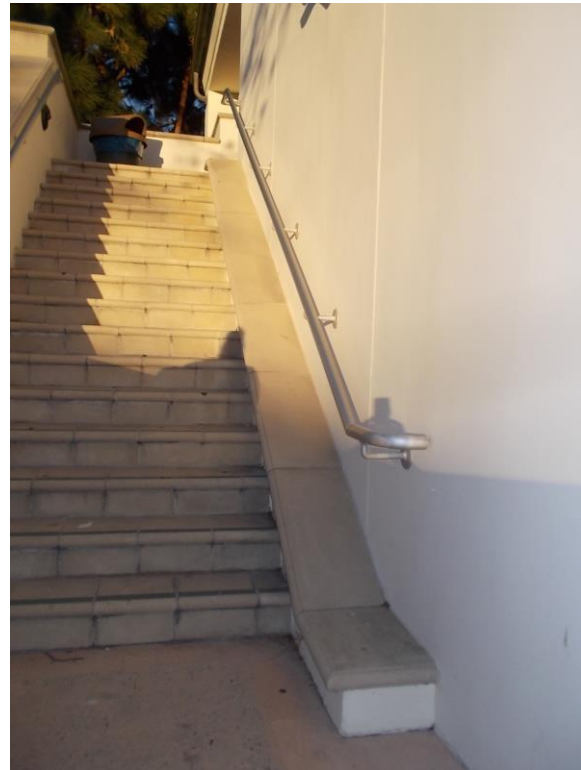

ST4. Exterior north stair exceeds distance to handrail from edge of stairs.



ST5. East exterior stairs with non-compliant landing length.



ST6. East side of building; exterior stair handrail finish degraded, and non-compliant height.



ST7. North side of building; exterior stair with non-compliant handrail heights and returns.



ST8. North side of building; exterior stair with damaged nosing, and missing handrail at change in stair direction.



## ACCESSIBILITY

- Elevators



EV1. Elevator access to all floors.



EV2. Braille floor level signs lacking.



EV3. Elevator car interior.



EV4. Elevator car ceiling; missing light lens.

## ACCESSIBILITY

- Signage



S1. Second floor; wayfinding signage at elevator.



S2. Third floor; wayfinding signage vandalized.

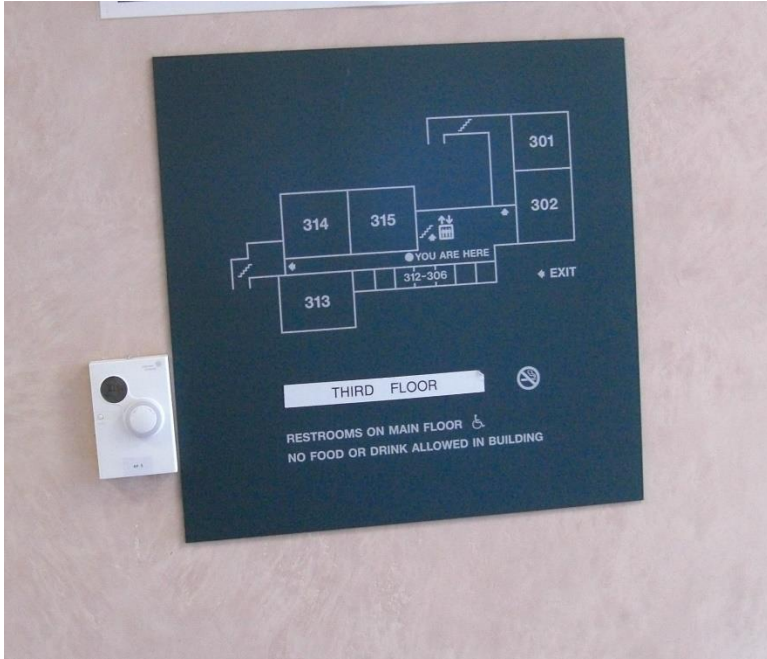

S3. Third floor, evacuation signage, missing extinguisher and fire alarm pull locations.



S4. First floor; typical room ID signage.

## ACCESSIBILITY

- Path of Travel



PT1. West side; main entrance plaza.



PT2. West side of building; excessive cross and longitudinal slopes along path of travel.



PT3. West entry plaza; abrupt change in level and hazardous surface features along path of travel.



PT4. West entry plaza tree well; hazardous surface feature along path of travel.



PT3. West side ramp to main building entry; intermediate landing exceeds the 2% allowed maximum cross slope.



PT5. South side of building, Offices 115-117; door threshold slopes exceeds the ½" maximum height, and push-side dimensional clearances not provided.



PT6. East side of building; non-accessible entry lacks wayfinding signs directing user to ramped entry location.



PT7. South side of building, ramp leading to Room 101; One handrail missing, non-compliant height at existing handrail, and drain grate creates abrupt and non-level lower landing.



PT8. South side of building; excessive cross and longitudinal slopes, and abrupt change in level and hazardous surface features along path of travel.



PT9. Northeast exterior walkway; uneven asphalt to concrete transitions. Abrupt change in level and hazardous surface features along path of travel.



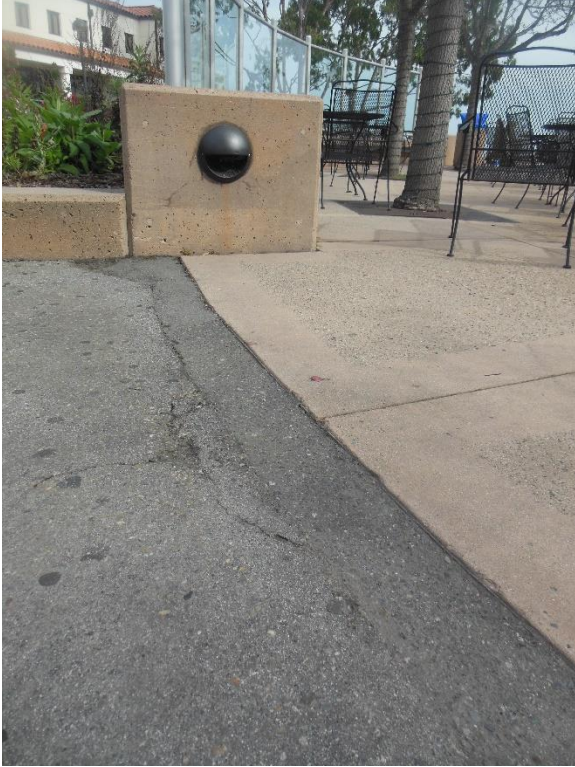

PT10. Outdoor Café pathway material transition; abrupt change in level and hazardous surface features at path of travel.

# **APPENDIX C EXISTING BUILDING DETAILS**

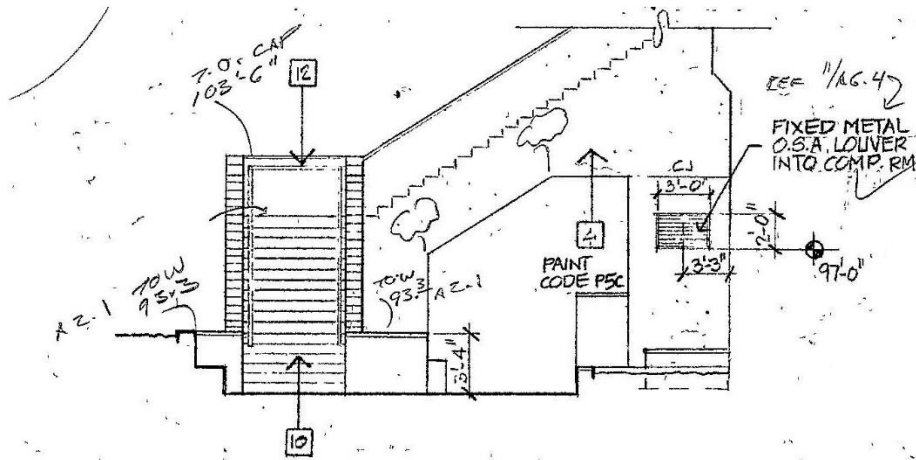
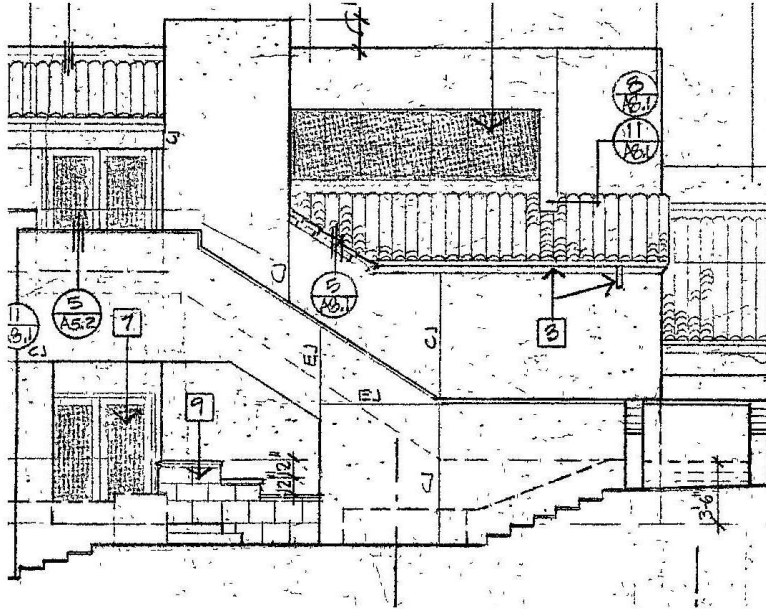

4 PARTIAL WEST ELEV.

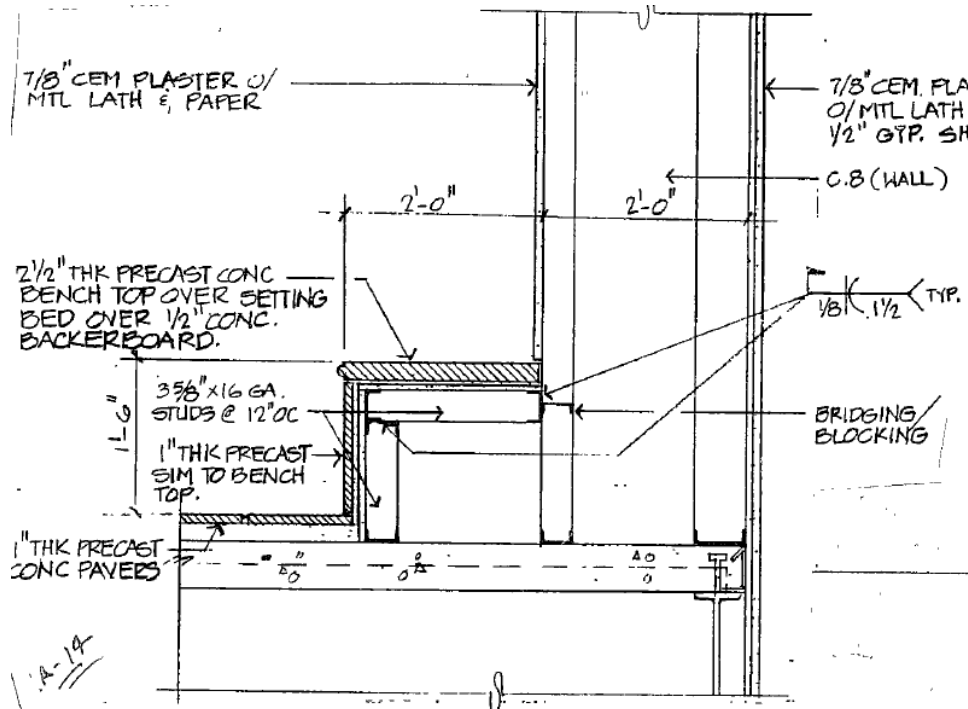
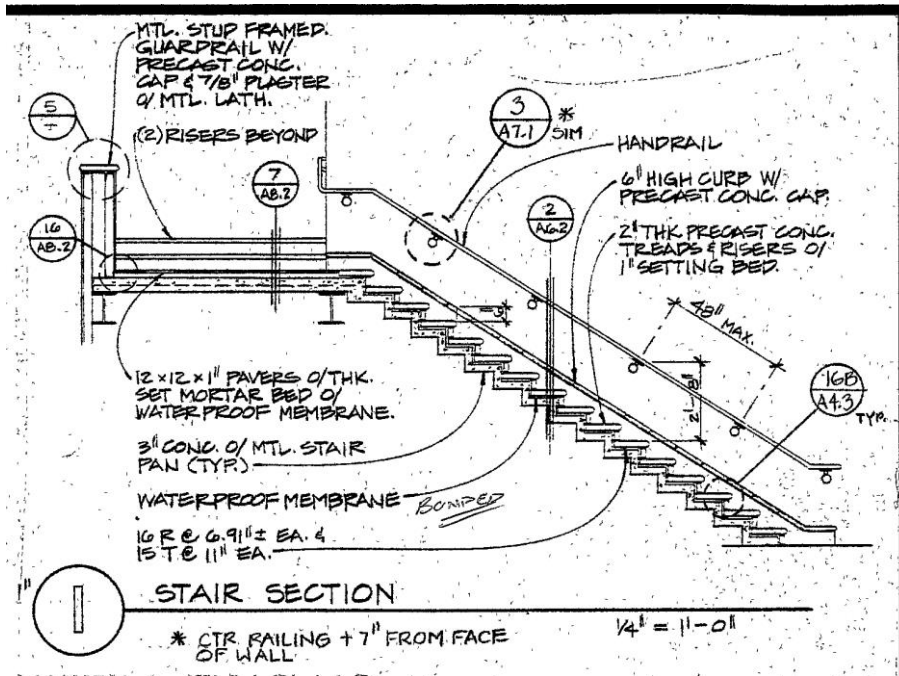

# Facility Condition Assessment Report INTERDISCIPLINARY CENTER

*Prepared for*



**SANTA BARBARA CITY COLLEGE**

**Santa Barbara City College – Main Campus  
721 Cliff Drive  
Santa Barbara, CA 93109**

RJC Project No: 2015.46



*Prepared by*  
**RJC Inc.**

**Facility Condition Assessment Report**  
**Santa Barbara City College – Main Campus**  
**Interdisciplinary Center**

**721 Cliff Drive**  
**Santa Barbara, CA 93109**

**March 4, 2016**

---

---

*TABLE OF CONTENTS*

Description

Number

Page

1. Facility Description	2
2. Major Findings	3
3. Site Findings	4
4. Architectural Findings	5
5. Mechanical Findings	6
6. Electrical Findings	7
7. ADA Building Descriptive Report	8
8. Inspector's notes	9
9. Summary	9

Appendix

A. Building Plans	10
a. First Floor	11
b. Second Floor	12
c. Third Floor	13
B. Photo Log & Narrative	14-37
C. Existing Building Details	38-40

# **1. Facility Description**

Year Built: 1988

Floor Area: 35,795 sf

Construction type: II FR

Occupancy: A3

The Interdisciplinary Center is a three story building on a sloping site. The building was built in 1988, with concrete slab on grade, exterior concrete block walls, and cast in place concrete structural columns. The exterior building finish is painted plaster with exterior quarry tile walkways and broom finished concrete sidewalks. Metal stud wall framing is utilized throughout, with 10" precast pre-stressed concrete plank floors with a 2-1/2" topping on the 2<sup>nd</sup> and 3<sup>rd</sup> floors. The roof system is a combination of membrane roofing with tapered insulation, plaster covered parapets, and clay tile over metal decking and rigid insulation. The roof area houses two mechanical wells. The building has metal gutters, conductor heads and downspouts leading to perforated drains. Vertical circulation elements include an elevator, interior stairwells, and exterior staircases.

The interior spaces have suspended acoustic tile and plaster ceilings, exposed concrete masonry walls, painted gypsum board walls, carpet tile, rubber wall base, and resilient flooring. The classrooms are equipped with operable whiteboards with overhead media projectors and screens. The exterior fenestration is a prefinished aluminum storefront system with both operable and fixed glass windows. The interior doors are both painted hollow metal and stained wood with flush vision panels. The first floor Computer Room 104 has a raised access floor. Hallways have wall mounted display cases and fabric covered tack boards.

The corridors on the first floor are 2 hour construction, and the second and third floors are one hour. The third floor incorporates an interior light court, with offices on each side of a corridor encircling the building. There are classrooms on the first and second floors accompanied by instructor office space and administrative functions of various departments on the third floor.

All three floors of the IDC building have both men's and women's accessible restrooms in addition to new water fountain/bottle filling stations. The restrooms have the original ceramic floor and wall tile, plumbing fixtures, ceilings, and lighting.

The area around the building is both paved and landscaped, offering several locations in which to enter the building with a mixture of wheelchair ramps, sloped walks, and stairs.

The building has a Class II Standpipe system within the interior stairwells, and is not required to be sprinklered. The fire alarm devices are connected to the campus wide fire alarm system and all levels have fire extinguishers spaced appropriately and are identified on the evacuation maps. Each exit door is properly accented with illuminated exit signs, and fire alarm pull stations.

## 2. Major Findings

The building has had door hardware, HVAC, fire alarm, fire access road, irrigation and planting, and interior finish renovations. Between 2013 and 2015, all three floors underwent interior finish upgrades including carpet and base, wall paint, resilient flooring, door refinishing and hardware upgrades, signage, water fountain replacement, window coverings, and some intranet re-wiring. The above mentioned interior finishes range from good to excellent condition.

The following are major findings discovered during the assessment:

- Ceiling systems – The suspended ceiling system is original, and many of the 2x4 acoustical ceiling tiles are damaged or stained and are in need of replacement. The ceiling suspension grid system is bent or damaged in some locations and requires repair. Additionally, the suspended ceiling system components such as: suspension hanger and bracing wire types and attachments, compression posts, main and cross runners, splices, expansion devices, intersection connectors, fire rating, and total system weight, likely no longer meet current ASTM ratings, the CBC, nor Department of the State Architect (DSA) requirements.
- Interior lighting – 2x4 recessed light fixtures in the t-bar ceiling system are original, have not been updated, and may no longer meet Energy (Title 24) requirements. Wall mounted lighting fixtures at the restrooms are missing lenses, dimly light the spaces, and should be re-evaluated and upgraded. The facility has an ongoing project to replace the old lamps with LED lamps throughout the campus.
- Restrooms – The restrooms on all levels are used by both students and staff; no ‘staff only’ restroom facilities are present. The restroom plumbing fixtures appear to be functional. The finishes and colors are in fair condition, but are dated and in need of refurbishment. Although the layouts and configurations are efficient, these restrooms were originally designed to meet 1988 ADA standards, and should be re-evaluated for compliance to current ADA codes. It is apparent there are numerous items that no longer meet current codes for accessible dimensional clearances such as: lavatory height, knee and side clearances, fixture reach ranges, grab bar heights, toilet compartment toe clearance and stall widths, as well as compartment door swing direction and type.
- Drinking Fountains - The (3) three alcove drinking fountains in the building have been recently upgraded to bottle filling station/drinking fountains, but no hi-low fountains are provided. Therefore, the building does not meet the 50% ratio of hi-low accessible drinking fountains required by code, and accommodations should be provided. Additionally, the alcove widths do not provide the required maneuvering clearances.
- Life Safety Systems - The Fire Alarm system was upgraded and certified by the Department of the State Architect (DSA) in 2015 and requires no further work.
- Roofing – The clay tile roof tiles are in overall good condition, with repair required mainly at the mortar below the hip tiles. The built-up roofing at the mechanical roof wells, however, has ponding water and possible structural damage underneath the roof material in these wet areas.
- There is no exterior pathway to the building that meets current accessibility requirements.



### **3. Site Findings**

The building sits on a slope, creating entrances at various levels on each side of the building. The intended accessible path of travel around the building is unclear as there are no site wayfinding directional signs. The main building entrance is also not marked with an International Symbol of Accessibility (ISA) sign.

Exterior circulation around the building is upon both asphalt and concrete paving. At multiple locations along the presumed accessible path of travel, cross slopes exceed the maximum 2% allowed, and longitudinal slopes exceed the maximum-allowed 5% and are without handrails. There are various points along the path of travel that have abrupt changes in level and hazardous surface features.

The paved surface from the IDC building to the accessible parking spaces in the adjacent parking structure is not ADA compliant. There are crumbled, uneven and degraded asphalt to concrete transitions, ground down high spots in the concrete walks, no wayfinding signs, and no detectable warning pavers at the flush vehicular influences.

The exterior ramped approach to the main entrance on the west side of the building is missing handrails on one side of the ramp, the existing handrail returns are non-compliant, the landings exceed 2% cross slope, are not level, and thus do not meet current codes.

The east entry paving slope is in excess of 5% without handrails, continues over a concrete swale and into a fire truck lane. There are no detectable warning pavers at the flush vehicular influence and no walkway surface separating pedestrians from the vehicles.

The south entry paving slope is in excess of 5% without handrails and thus is not accessible.

The handrails at the exterior stairs at the north building entrance are 32" high, do not meet the current minimum height requirements of 34", and do not continue along the full length of the mid-landing. The handrail finishes are corroded, in poor condition and require refurbishment.

The exterior staircase on the south corner of the building has non-compliant handrails returns as well as mid-landing 42" high handrails, which exceed the maximum 38" height allowed. The handrail finishes are corroded, in poor condition and require refurbishment.

## **4. Architectural Findings**

Although the majority of the interior finishes range from good to excellent condition, the following architectural items were discovered during the assessment:

**ROOF:** Built up roofing at the mechanical roof wells have standing water, poor roof drainage, and potential underlying damage possibly caused by the old, poorly maintained mechanical equipment in the same location.

**CEILINGS:** The ceilings in the facility are the original 2x4 suspended acoustic tile and plaster ceiling systems. Some lay-in tegular ceiling tiles have water and stain damage, and at various locations grid members are bent and require refurbishment. The suspended ceiling system may no longer meet current code requirements and regulations, were not included in any of the upgrades done between 2013 and 2015, and would greatly benefit from refurbishing.

**WALLS:** The exterior wall finish is plaster over both concrete and concrete masonry units. The plaster has minor hairline cracks, but otherwise appears to be in good condition, and has been recently painted. The majority of the interior walls are painted gypsum board over metal stud framing, utilizing corner guards, are recently painted and in very good condition. The interior stairwell wall finishes are peeling, show signs of wear and require repainting.

**FLOORING:** The corridor flooring on the first and second floors was not upgraded during the refurbishment projects, and is the original 12"x12" vinyl composition tile (VCT). It requires regular maintenance to keep it in fair to good condition, and has a few scratches and minor holes. These flooring surfaces would benefit from a modernization to match the lifespan of the other new materials throughout the building.

**RESTROOMS:** The restrooms have the original colors, finishes, and fixtures, which would benefit from a modernization to match the lifespan of the other new materials throughout the building. Multiple toilet partitions have been purposely defaced and should be replaced with products better suited to withstanding vandalization. The layouts require reconfiguration to meet current accessibility codes for dimensional clearances.

## **5. Mechanical Findings**

The building does not have air conditioning, and during the warm summer months the interior spaces become very hot. Window tinting, ceiling mounted classroom fans and window shades with high UV reflectance qualities are methods utilized to help reduce the higher interior building temperatures. Additionally, the third floor staff offices open windows, and utilize stand up fans.

The IDC building has two rooftop equipment wells. The larger west well has one chiller, one Air Handler Unit (AHU), and one exhaust fan. The smaller east well has one boiler and one AHU. The rooftop air handlers, chiller, boiler, exhaust fan, piping, piping insulation, pumps, valving, controls and accessories are at the end of their the useful life and should be replaced. This is four pipe hydronic heating and cooling system with gas fired boiler and air cooled chiller. A second inline exhaust fan serves Room 116 and is located in the Electrical room. It has also reached the end of its useful life.

In 1999, the air distribution ducts were rerouted, three VAV units, one chiller pump, and air distribution were added.

The belts, filters, and motors are a regular, ongoing maintenance issue.

The remaining original indoor air distribution and VAVs/fan coils/fin tube radiators and controls are of original construction, but are in good working order. VAVs/fan coils/radiators need to be inspected, and ducts need to be cleaned.

There is debris and storage items blocking the minimum clear working space around all mechanical indoor equipment.

All equipment was properly marked. Rooftop units, piping and curbs meet minimum clearances, supports are secured to the structure, properly seismically restrained, and vibration isolation is present. The rooftop equipment disconnecting means are present, are in-site and readily accessible. Exterior ducts are protected by weatherproof barriers, and duct smoke detectors are present. The outside air intake vent distances and air inlet screen protection are in place. The exhaust discharge clearances to walls, roofs, operable openings and grade are within code requirements. Rooftop condensate lines discharge flows to drains connected to the sewer system. Refrigerant pipe and tubing are compliant and refrigerant detectors are present. Boiler shutoff valves are present in the supply/return piping. Pipe hangers/anchors/supports are within proper spacing.

## **6. Electrical Findings**

The main electrical switchgear and transformer are located in Room 116. Both are original; the switchgear appears in good condition, but the transformer has reached the end its useful life and should be replaced. There are indoor substations located throughout the building. Around the main switchgear there is debris and storage items blocking the minimum clear working space.

Service Disconnecting Means are present, in good working order, are in-site and but are not readily accessible as there is debris and storage items blocking the minimum clear working space in front of the electric equipment. Ground Fault Protection and grounding electrodes are present and appear in good working order. Electrical panels have circuit directories, but it is unknown if the directories are up to date. Energy efficient lighting for interior and exterior are being upgraded on an on-going basis. Life-safety elements and emergency lighting are present. Adequate illumination of interior & exterior spaces appears to be present, but indoor and outdoor lighting fixtures are older, and may not meet current Title 24 code requirements.

## **7. ADA Building Descriptive Report**

Due to site and built conditions, there is no code compliant entrance to the IDC building. Once inside the building, the corridor widths are compliant, proper door clearances are provided, and an elevator provides access to all floors.

The main building entry at the west side and is intended to be the wheelchair accessible entrance, but lacks any signage to indicate accessibility, such as an International Symbol of Accessibility (ISA) symbol. It is accessed via a curbed ramp, as well as stairs with hand rails. This entry does not meet current accessibility requirements because the ramp does not have railings on both sides and the landings are not level.

The entry doors on the east side of the building are not considered accessible, as the door thresholds exceed the ½" maximum height without being beveled at a 2:1 slope, and do not lead to a code compliant exterior ADA path of travel.

The entry doors on the south side of the building are also not accessible, as the exterior walking slopes leading up to it exceeds the maximum 5% slope.

The entry doors on the north side of the building are accessed by a non-compliant set of stairs.

Electronic door operators are adjacent many exterior doors, but lack the lower access button required by current code.

Both the building and the immediate surrounding site is severely lacking exterior and interior path-of-travel and wayfinding signage as required by code. There are no International Symbol of Accessibility (ISA) signs indicating the location of the accessible door.

Although the building does have updated compliant interior room identification signs and large directory signs, the building does not have exterior visual, tactile or Braille door identification signs at any entrance doors, causing confusion for all users. Without these signs, it becomes difficult to navigate the building without retracing steps or going significantly out of your way to find an accessible exit or entry.

Stairwell exiting signage is inadequate and non-compliant at all floors. Tactile identification signs identifying the floor level, stair level and exit level are not provided at the 3<sup>rd</sup> floor stairwell door. Additionally, the stair nosings lack the required upper and lower visual warning stripes.

Drinking fountain/bottle filling stations do not provide adequate maneuvering clearances, nor are the required number of hi-low fountain fountains provided.

Elevators are lacking the proper tactile and Braille floor designations at the jambs of each floor, and there is no verbal annunciator to announce the floor at which the car is stopping at.

## **8. Inspector's Notes:**

The IDC building has been generally well maintained, is fully functional for its intended uses, and closely reaches the level of other college and educational buildings of this type.

The surrounding site is in need of modernization to be brought up to current ADA accessibility codes, and the building is recommended for modernization of entry access, ceilings, floors, lighting, mechanical and electrical systems.

There is debris and storage items blocking the minimum clear working space around both the main electrical switchgear and service disconnecting means as well as around all mechanical indoor equipment. The items should be relocated immediately to increase building safety, eliminate fire hazards and provide the code required minimum clear working space.

## **9. Summary:**

The IDC building has undergone multiple interior renovations of offices and classrooms, bringing floor, wall and door finishes up to a higher level of quality to last for many years. The existing ceiling system, corridor flooring, stairwell finishes, restrooms fixtures and finishes have reached the end of their useful life, require replacement, and would benefit from a modernization to match the quality and life-cycle of the office and classroom finish materials.

The lower level plaza area is a paved, open and shaded space, and would benefit from a renovation to offer users a place to gather and sit.

The building is not conditioned, and it is recommended the system be upgraded and should include air conditioning throughout. The roof-top mechanical equipment requires replacement, and built-up roof system repair should occur at the same time. An overall clean-up of both mechanical and electrical rooms is recommended to remove debris causing hazardous working conditions.

The IDC building is severely lacking in ADA compliant accessibility in and around the building. There is no compliant path of travel from the accessible parking stalls, nor a compliant building entry. Sidewalks, stairs, and entrance ramps within the building limits are not ADA compliant, and the elevator do not meet all current regulations.

# **APPENDIX A BUILDING PLANS**

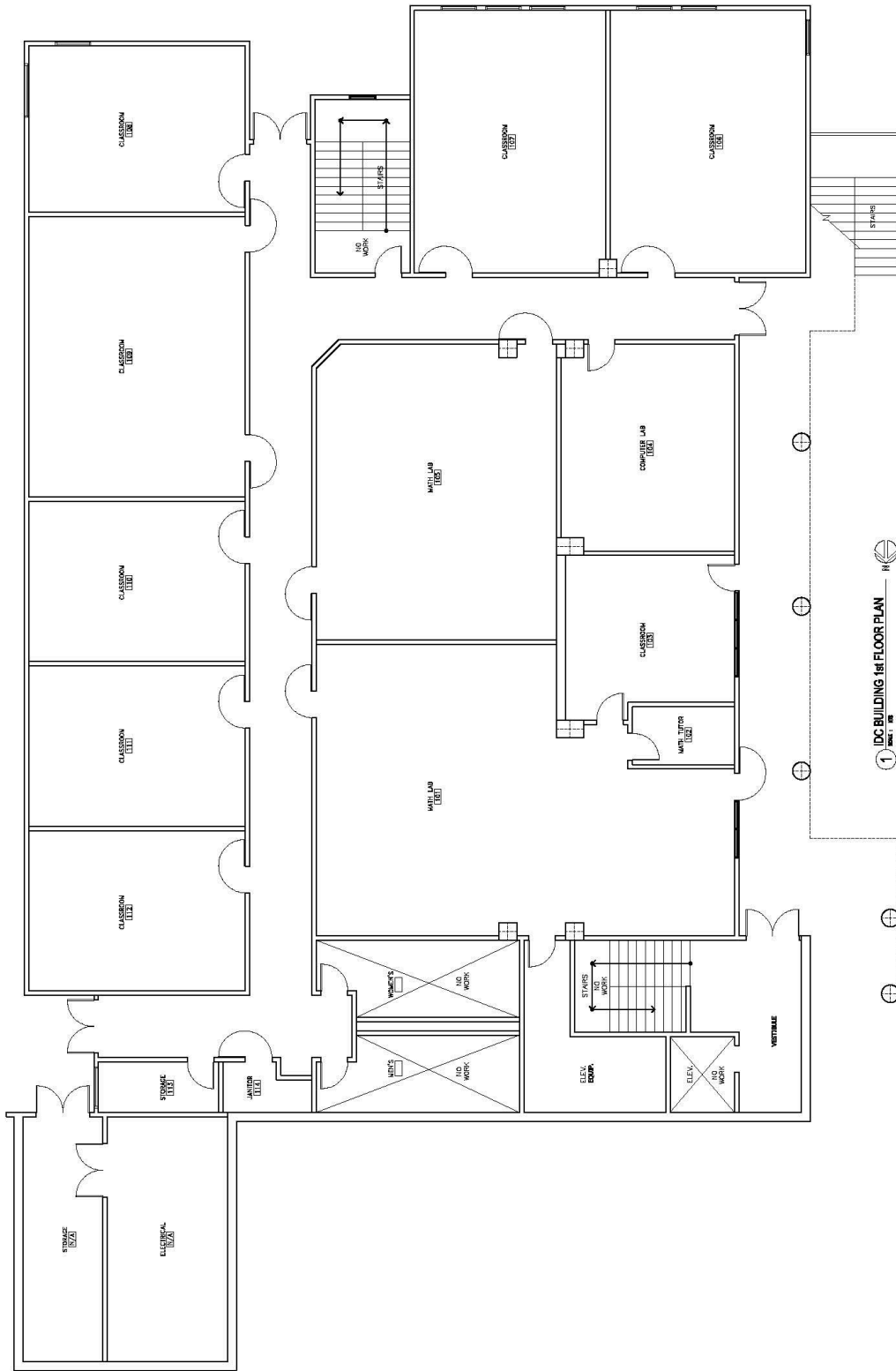



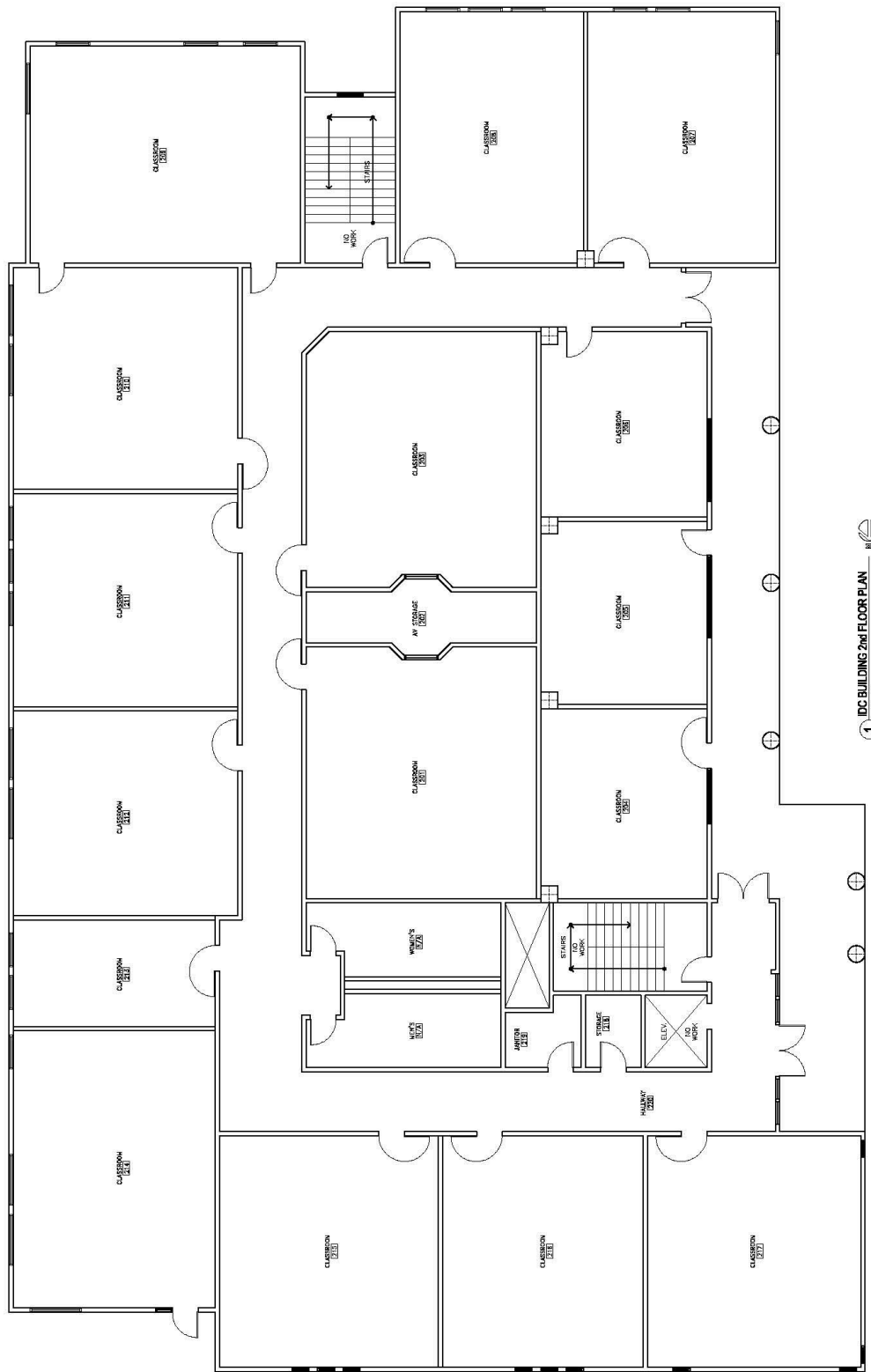

1 IDC BUILDING 2nd FLOOR PLAN

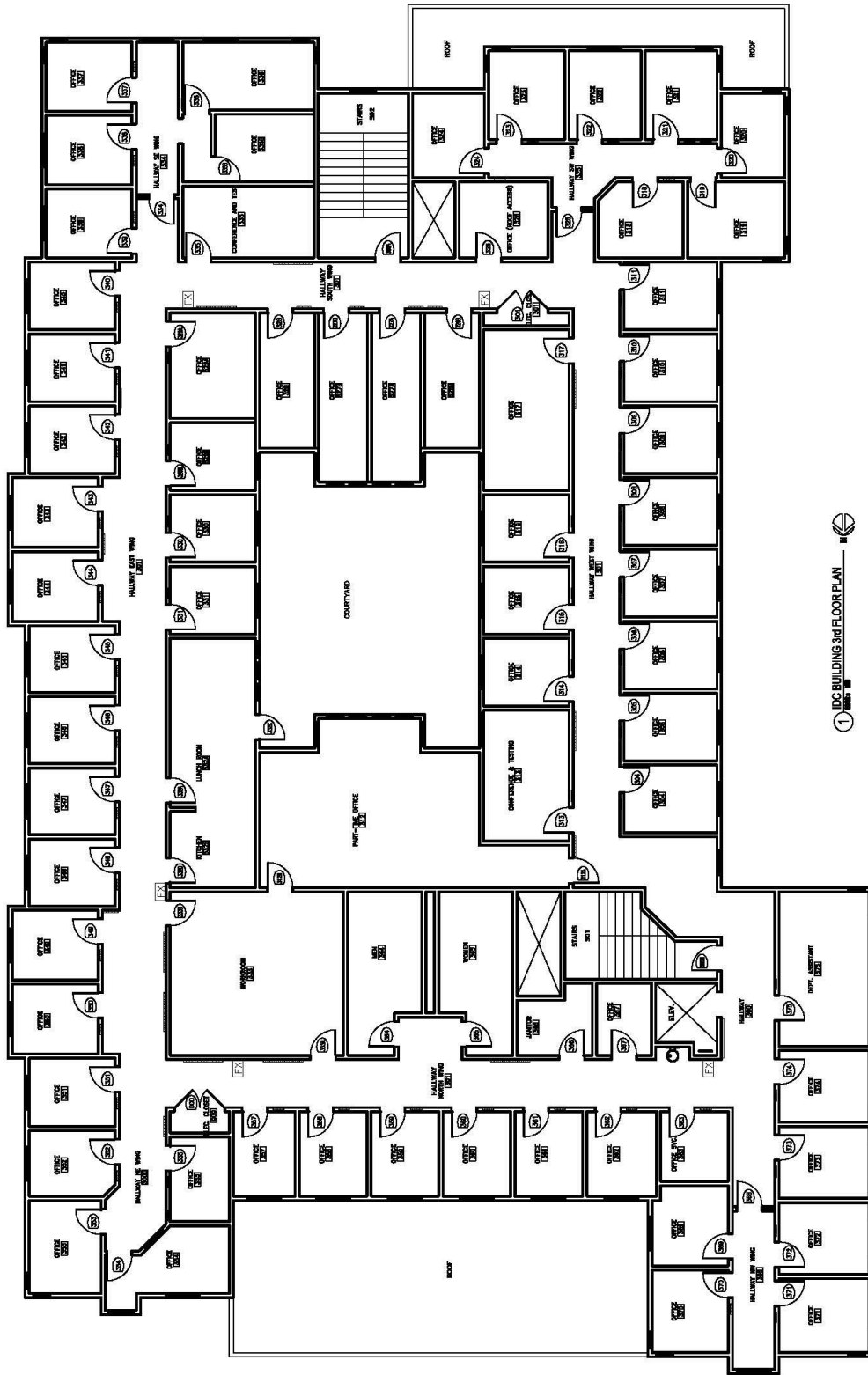

1 IDC BUILDING 3rd FLOOR PLAN

# APPENDIX B

## PHOTO LOG & NARRATIVE

1. Architectural
  - a. Exterior
    - 1) Wall Finishes
    - 2) Roof Systems
    - 3) Entrances/Doors
    - 4) Windows
    - 5) Floor Finishes
  - b. Interior
    - 1) Wall Finishes
    - 2) Ceiling Systems
    - 3) Doors
    - 4) Floor Finishes
2. Building Systems
  - a. Mechanical
  - b. Electrical
3. Accessibility
  - a. Restrooms
  - b. Drinking Fountains
  - c. Stairs
  - d. Elevators
  - e. Signage
  - f. Path of Travel

## EXTERIOR

- Wall finishes



AE1. West facing entrance plaster wall.



AE2. West facing entrance overhang cracked plaster finish with water damage.



AE3. First floor CMU wall under overhang with efflorescence (white mineral deposits) from water intrusion above.



AE4. First floor CMU column under overhang with paint finish damage.

## EXTERIOR

- Roof Systems



R1. Mechanical roof well with water damage at built up roofing system.



R2. Mechanical roof well with water damage at built up roofing system.



R3. Clay tile roof system, in good condition.



R4. Clay tile roof system with metal downspouts, in good condition.

## EXTERIOR

- Entrances/Doors



D1. First floor south entrance doors.  
Doors are lacking code required signage and ISA symbols.

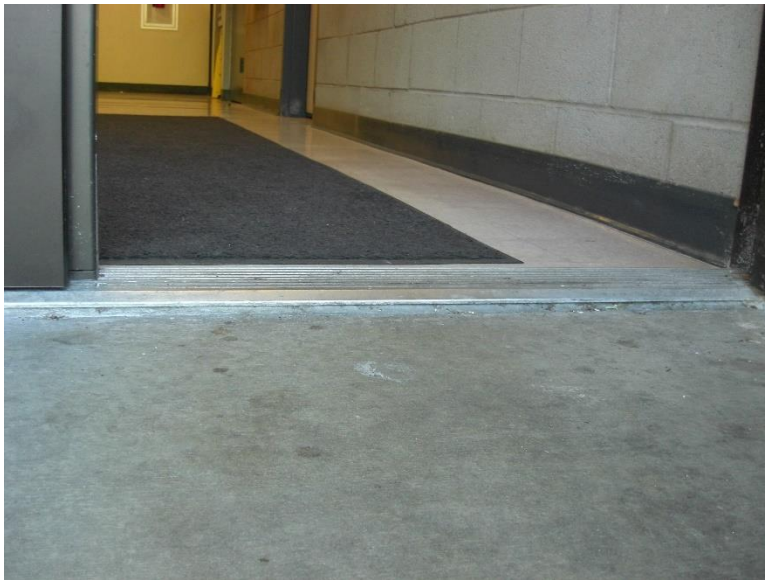

D2. First Floor south entrance doors with non-compliant threshold.  
Transition exceeds the 1/2" maximum height without being beveled.





D3. First floor west lower entrance doors;  
Right hand door abuts the adjacent wall without  
providing hand clearance to avoid pinching.

## EXTERIOR

- Windows



EW1. West wall, second floor storefront window system in good condition.

## EXTERIOR

- Floor Finishes



EF1. Second floor exterior colored, scored concrete walkway; good condition.



EF2. Second floor exterior ceramic tile walkway; good condition.

## INTERIOR

- Wall Finishes



AI1. First floor interior corridor CMU walls; good condition.



AI2. Third floor interior corridor walls; good condition.

## INTERIOR

- Ceiling Systems



C1. First floor corridor ceiling system; water damaged.



C2. First floor corridor ceiling tile; damaged.

## INTERIOR

- Entrances/Doors



D1. First floor equipment room door.  
Door protection attached to door.



D2. Third floor stairwell door; crossbar style panic hardware does not match other exit doors touchpad style.



D3. Third floor stairwell door with damaged lever hardware.



D4. Second floor stairwell door with damaged paint, and no panic hardware.



D5. Third floor office door with damage edge at latch.

## INTERIOR

- Floor Finishes



IF1. Second floor entry corridor; cracked and damaged VCT flooring.



IF2. Second floor corridor; scratched/damaged VCT flooring.





IF3. First floor exit passageway at stairwell enclosure by elevator. Damaged rubber flooring and resilient base.



IF4. Third floor corridor carpet tile in excellent condition; installed in 2015.

## Building Systems

- Mechanical



M1. Rooftop mechanical equipment at end of useful life.



M2. Rooftop mechanical equipment at end of useful life.

## Building Systems

- Electrical



E1. Electrical equipment lacking clear floor space required by code.

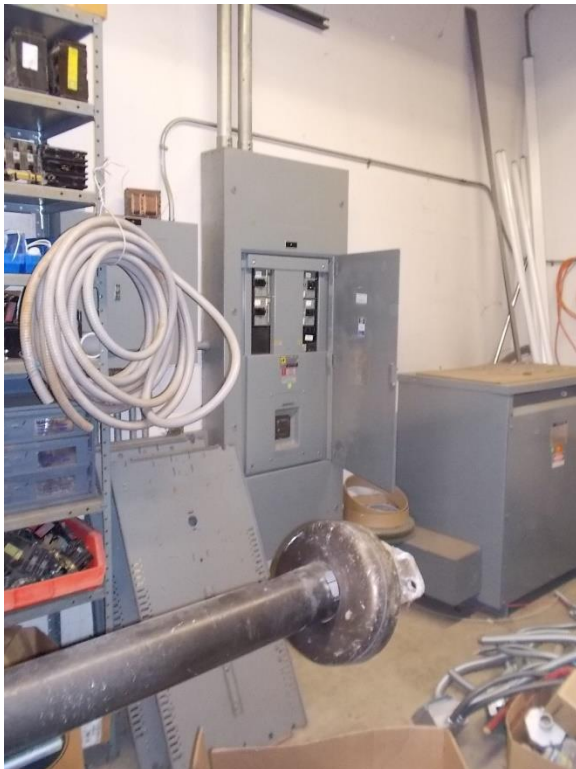

E2. Electrical equipment lacking clear floor space required by code.

## ACCESSIBILITY

- Restrooms



RR1. Mens restroom, accessible clear floor space not provided. Mirror and soap dispenser mounted above ADA compliant heights.



RR2. Womens restroom. Door signage does not meet minimum contrast requirements with adjacent surface.

## ACCESSIBILITY

- Drinking Fountains



DF1. Bottle filling station/drinking fountain.  
Compliant maneuvering clearances are not provided.

## ACCESSIBILITY

- Stairs



ST1. South exterior stairs with non-compliant and corroded handrails.



ST2. North exterior stairs with non-compliant and corroded handrails.

## ACCESSIBILITY

- Elevators



EV1. First floor elevator doors; missing proper signage.

## ACCESSIBILITY

- Signage



S1. Directory and Evacuation Signage; first floor.



S2. Stairwell exiting signage is inadequate; second floor.



## ACCESSIBILITY

- Path of travel

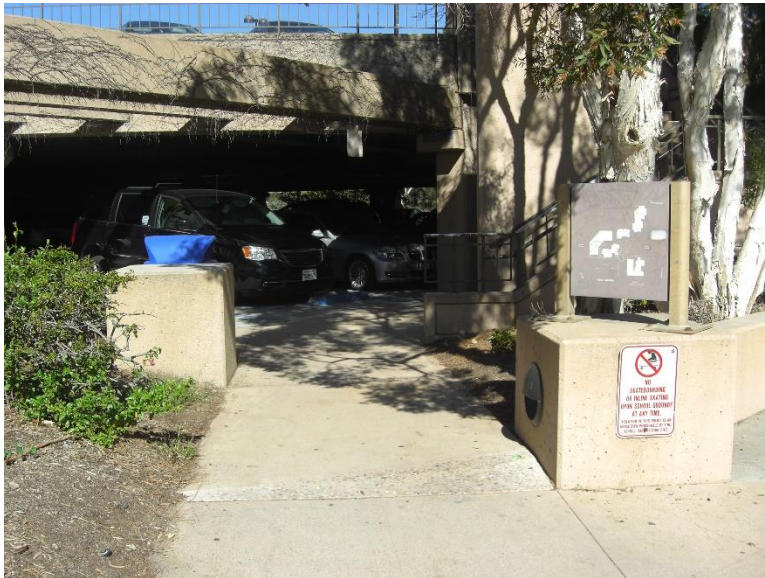

PT1. Paved surface from the IDC building to the accessible parking stalls is uneven and degraded. Path of travel sign is missing.



PT2. Asphalt to concrete transition along path of travel from the IDC building to the parking lot is crumbled, uneven and degraded.



PT3. Non-compliant ramp at west main entry.



PT4. Non-compliant walkway at east main entry.

# **APPENDIX C**

## **EXISTING BUILDING DETAILS**

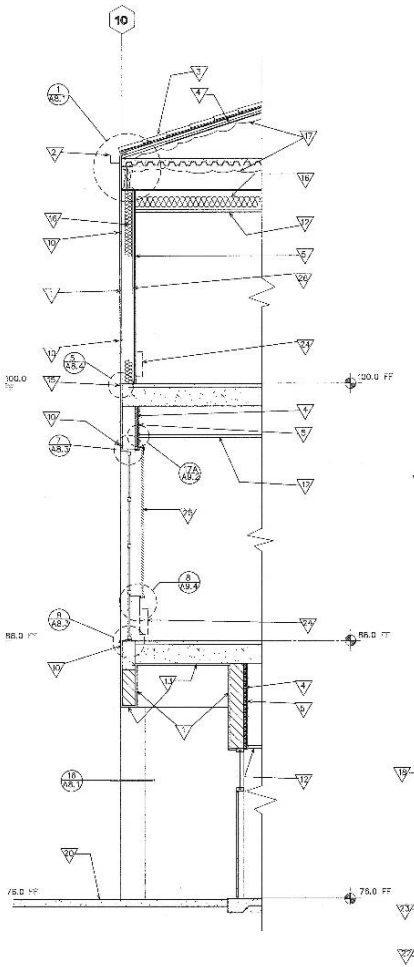

**SECTION E**  
1/2" = 1'-0"

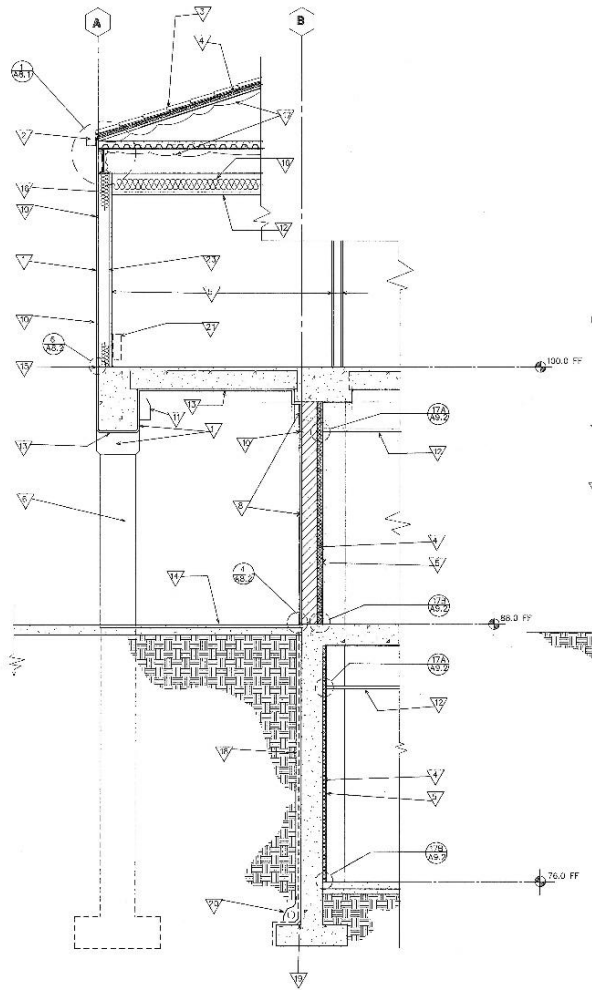

**SECTION H**  
1/2" = 1'-0"

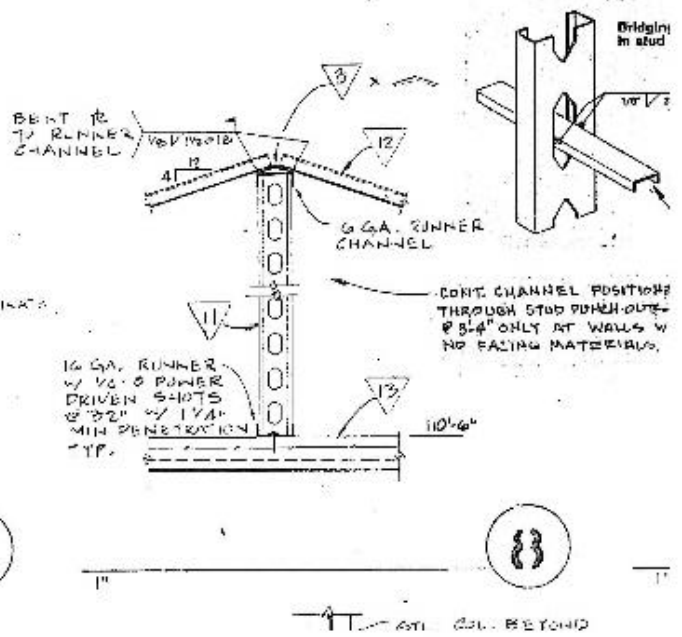
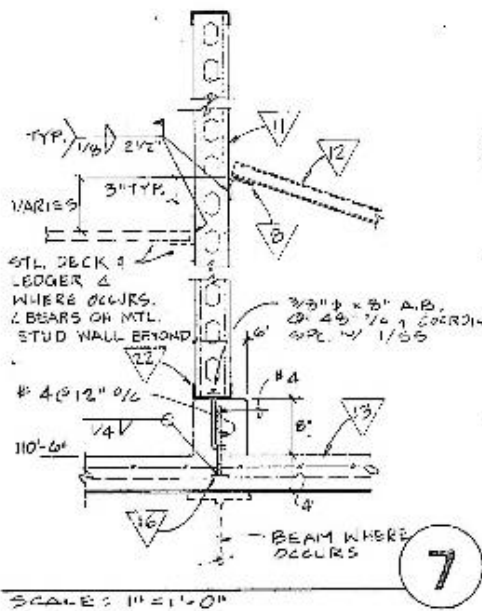

# Facility Condition Assessment Report LEARNING RESOURCE CENTER

*Prepared for*



**SANTA BARBARA CITY COLLEGE**

**Santa Barbara City College – Main Campus  
721 Cliff Drive  
Santa Barbara, CA 93109**

RJC Project No: 2015.46



*Prepared by*  
**RJC Inc.**

**Facility Condition Assessment Report**  
**Santa Barbara City College – Main Campus**  
**Learning Resource Center**  
**721 Cliff Drive**  
**Santa Barbara, CA 93109**

March 4, 2016

---

---

*TABLE OF CONTENTS*

*Description*

<i><u>Number</u></i>	<i><u>Page</u></i>
1. Facility Description	2
2. Major Findings	3
3. Site Findings	4
4. Architectural Findings	5
5. Mechanical Findings	6
6. Electrical Findings	7
7. ADA Building Descriptive Report	8
8. Inspectors Notes	9
9. Summary	9

*Appendix*

A. Building Plans	10
a. First Floor	11
b. Second Floor	12
B. Photo Log and Narrative	13-45
C. Existing Building Details	46-48

# **1. Facility Description**

Year Built: 1987

Floor Area: 52,335 square feet

Construction type: II - One hour

Occupancy: Mixed occupancy: B-2 (offices and education), A-3 (assembly)

The Learning Resource Center on the West Campus is a two story building on a sloping site adjacent the pedestrian bridge, with the Learning Center occupying the west side of the building, and the Library on the east. The building was built in 1987 with concrete slab on grade, first floor concrete cast in place walls, second floor exterior steel stud walls with batt insulation, and steel and concrete structural columns. The exterior building finish is painted plaster, with exterior broom finished colored concrete sidewalks. Metal stud interior wall framing is utilized throughout, with poured in place concrete floors. The roof system is a combination of membrane roofing with tapered insulation over metal decking, plaster covered parapets, and clay tile with underlayment, over rigid insulation and metal decking. The building has metal gutters, conductor heads, scuppers, and rainwater leaders flowing to subsurface perforated drainage pipes. Vertical circulation elements include an elevator as well as interior and exterior staircases.

The interior spaces have suspended acoustic tile and plaster ceilings, painted gypsum board walls, operable partitions, broadloom carpet, carpet tile, rubber and resilient flooring, wall base, recessed door mats, casework, shelving, display cases, marker boards, and fabric covered tack boards. The Learning Center interior space on the west side of the building was modernized in 2012, while the Library on the east side of the building retains the original carpet, resilient flooring, wall base, paint, ceilings, casework, shelving, and furnishings. The west side of the building utilizes a depressed slab with an access floor, and the east side incorporates underfloor ducts to provide power and data to the open floor plan. The interior doors are a combination of painted hollow metal and painted and stained wood with flush vision panels. The exterior entry doors are anodized aluminum with glazing.

The exterior windows on the lower level are set back and shaded from the floor above. The second floor windows are shaded with prefinished standing seam metal awnings. Acrylic domed skylights provide natural lighting at the building entrance lobby, Library interior stairs, and above the distribution counter in the Learning Center.

Both floors of the LRC building have both men's and women's accessible restrooms in addition to water fountains. The restrooms have the original ceramic floor and wall tile, plumbing fixtures, ceilings and lighting.

The area around the building is both paved and landscaped, offering several locations from which to enter the building with a mixture of sloped walks and stairs.

The building is both sprinklered and furnished with fire alarm devices connected to the campus wide fire alarm system. All levels have fire extinguishers spaced appropriately, and each exit door is properly accented with illuminated exit signs and fire alarm pull stations.



## **2. Major Findings**

The building has had interior renovations in 2012 to the Learning Resource space on the west side of the building, including new carpet, base, wall paint, ceiling tiles, lighting, casework, signage, door and window refurbishment, power and data revisions, new fixtures and furniture. Most finishes in this area remain in very good condition, though some walls require minor paint touch-up. Corridor 112 and Restrooms 103 and 104 have not been renovated, and the wall, floor and ceiling finishes are in fair to poor condition, and require refurbishment. Both levels of the Library space on the east side of the building have not be renovated, all finishes are original, are in extremely poor condition, and require replacement.

The following are major findings discovered during the assessment:

- Ceiling systems –The east side suspended acoustic ceiling tiles are in poor condition throughout; many have stains, are broken or damaged, and require replacement. The ceiling suspension grid system is in fair condition, but requires refurbishment. The painted concrete coffered ceiling at the lower level requires new paint. Additionally, the suspended ceiling system components such as: suspension hanger and bracing wire types and attachments, compression posts, main and cross runners, splices, expansion devices, intersection connectors, fire rating, and total system weight, likely no longer meet current ASTM ratings, the CBC, nor Department of the State Architect (DSA) requirements.
- Interior lighting - The recessed and suspended light fixtures at the east side are original, have not been updated, and may no longer meet Energy (Title 24) requirements. Wall mounted lighting fixtures at the restrooms have damaged lenses, dimly light the spaces, and should be re-evaluated and upgraded. The facility has an ongoing project to replace the old lamps with LED lamps throughout the campus.
- Restrooms - Both public and staff restrooms are provided at the upper and lower floor levels. The plumbing fixtures appear to be functional at all locations. The ceramic wall finishes are in fair condition, but the ceramic floor tile is very dirty and in poor condition. Additionally, these restroom finishes are dated and in need of refurbishment. Both the men’s and women’s Lobby restroom door finishes are badly damaged and require repainting. Although the layouts and configurations of the student restrooms are efficient, they were originally designed to meet 1987 ADA standards, and should be re-evaluated. There are numerous items that may no longer meet current accessible dimensional clearances such as: lavatory height, knee and side clearances, fixture reach ranges, grab bar heights, ambulatory stall width, and adequate exiting door clearances. The staff restrooms in all locations are in poor condition and no layout meets ADA dimensional clearances.
- Drinking Fountains - There are five locations of hi-low drinking fountains. The Lobby fountains are in a code compliant alcove and provide the proper side maneuvering clearances, but the high fountain was replaced with a bottle filling station. No other fountains are in an alcove, they protrude into a corridor or stair landing, and therefore the building does provide any compliant hi-low accessible drinking fountains.
- Life Safety Systems - The fire alarm system was upgraded, and certified by DSA in 2015 and requires no further work.
- Roofing - A few metal awnings on the north side of building are rusted, dented and are in need of repair. The clay roof tile is in overall good condition, but it is unknown if the roof tile tie-down system meets current Department of the State Architect (DSA) requirements.

### **3. Site Findings**

The building sits on a slope, creating entrances at various locations around the building.

An emergency fire lane wraps around the north side of the building, and outdoor plazas are along the west, east and south sides of the building, with trees, landscaping, picnic tables, benches, bicycle racks and pole lighting. The pavement does not have curbs nor tree grates, creating tripping hazards. A tree grate system should be installed to provide a safe extension of the pedestrian walk ways. The outdoor areas are lit with flood lights on the roof and would benefit from new site lighting.

The intended accessible path of travel to the main entrance on the south side of the building has cross slopes exceeding the maximum allowed 2%, and longitudinal slopes exceeding the maximum allowed 5% and are without handrails. There is no pathway to the building that meets current accessibility requirements.

Exterior circulation walkways around the building are both concrete paving and epoxy pebbled surfaces. At multiple locations along the south and east sides of the building, the longitudinal slopes exceed the maximum allowed 5% and are without handrails. There are various points along these walkways that have abrupt changes in level and hazardous surface features. The expansion joints between pavement panels are degraded, and require replacement. The immediate surrounding site is severely lacking exterior path-of-travel and wayfinding signage as required by code.

The sloped walkway around the north side of the building includes an excessively steep sloped asphalt ramp with no handrails or curb edges. This ramp continues into a driveway, and does not have detectable warning pavers at the vehicular influence.

The main entrance exterior south stairs are wide, and an intermediate center handrail is required due to the occupancy load of the building. These existing handrails also do not meet the current minimum height requirements of 34" and have non-code compliant returns. The lower stair landing exceeds the maximum allowed 2% slope, is not level, and considered non-compliant.

The exterior staircase handrails on the north side of the building are 32" high, and thus do not meet the current minimum height requirement of 34". These north stair risers also exceed the maximum allowed 7" in height.

## ***4. Architectural Findings***

The following architectural items were discovered during the assessment:

**ROOF:** Multiple standing seam metal awnings are rusted, damaged, and are in need of repair. There is damaged mortar at the roof tile ridge on the northeast side of the roof. The built-up roof system is in good to excellent condition.

**CEILINGS:** The ceilings on the east side of the building are both coffered concrete and original 2x4 suspended acoustic tile and plaster ceiling systems. Many of lay-in tegular ceiling tiles are damaged, require replacement, and the entire suspended ceiling system may no longer meet current code requirements and regulations, has not been upgraded, and would greatly benefit from refurbishing.

**WALLS:** The exterior wall finish is plaster over both concrete and steel stud construction. The plaster has minor hairline cracks, but otherwise appears to be in good condition and has been recently painted. The interior walls are painted gypsum board over metal stud framing, painted concrete, and fabric covered. The wall finishes on the west side of the building are in good condition, while all finishes on the east side are in very poor condition. Multiple locations have damaged drywall, marred and chipped paint, and badly stained wall coverings.

**FLOORING:** The flooring materials in the renovated portion of the west side of the building are in good to excellent condition, while the flooring in the north west section of the building is in fair to poor condition and would benefit from a modernization to match the lifespan of the other newer materials at the west side the building. Flooring materials in the east side of the building are not only dated, but are in extremely poor condition, are beyond cleaning, and require replacement.

**RESTROOMS:** Both public and staff restrooms have the original colors, finishes, and fixtures and would benefit from a modernization to match the lifespan of the other newer materials at the west side of the building. The layouts require reconfiguration to meet current accessibility codes for dimensional clearances.

## **5. Mechanical Findings**

The LRC mechanical system consists of two chillers, one boiler three Air Handler Units (AHUs), and twenty-one fan coils. There are three roof mounted AHUs. The boiler is in the Mechanical Room on the lower level. This is a two pipe hydronic heating and cooling system with gas fired boiler and air cooled chiller. There is also an outside air fan in the mechanical room. The boiler, outside air fan, piping, piping insulation, pumps, valving, controls and accessories are at the end of their the useful life and should be replaced

In 1997 there was an upgrade for three packaged rooftop heat pumps.

Two chillers were added to the building system in 2001 in an outside enclosure adjacent to the fire department access lane. Only one chiller is in use while the other is slated to serve the adjacent IDC building in the future. The piping, piping insulation, pumps, valving, controls and accessories appear to be in good condition and operating correctly.

The belts, filters, and motors are a regular, ongoing maintenance issue.

Indoor air distribution and fan coils and controls are of original construction, but are in good working order. Fan coils need to be inspected, and ducts need to be cleaned.

There are twenty-one original fan coils with replaced piping, piping insulation, valving, controls and accessories. They are in proper working order.

Some exhaust fans are original and some have been replaced on an as needed basis.

There are debris and storage items blocking the minimum clear working space around all mechanical indoor equipment.

All equipment was properly marked. Rooftop units, piping and curbs meet minimum clearances, supports are secured to the structure, properly seismically restrained, and vibration isolation is present. The rooftop equipment disconnecting means are present and are in-site and readily accessible. Exterior ducts are protected by weatherproof barriers, and duct smoke detectors are present. The outside air intake vent distances and air inlet screen protection are in place. The exhaust discharge clearances to walls, roofs, operable openings and grade are within code requirements. Rooftop condensate lines discharge flows to drains connected to sewer system. Refrigerant pipe and tubing are compliant and refrigerant detectors are present. Boiler shutoff valves are present in the supply/return piping. Pipe hangers/anchors/supports are within proper spacing.

## **6. Electrical Findings**

The main electrical switchgear and transformer are located in Room 106. Both are original; the switchgear appears in good condition, yet the transformer has reached the end its useful life and should be replaced. There are indoor substations located throughout the building. Around the main switch there are debris and storage items blocking the minimum clear working space. Multiple locations in the east side of the building have damaged or poorly wired outlets.

Service Disconnecting Means are present, in good working order, are in sight, but are not readily accessible as there are debris and storage items blocking the minimum clear working space in front of electric equipment. Ground Fault Protection and grounding electrodes are present and appear in good working order. Electrical panels have circuit directories, but it is unknown if the directories are up to date. Energy efficient lighting for interior and exterior are being upgraded on an on-going basis. Life-safety elements and emergency lighting are present. Adequate illumination of interior and exterior spaces appears to be present, but indoor and outdoor lighting fixtures are older, and may no longer meet current Title 24 code requirements.

## **7. ADA Building Descriptive Report**

The main building entry at the south side of the building is intended to be the wheelchair accessible entrance, but the layout of the three entry doors does not provide adequate push or pull-side dimensional clearances. An electronic door operator is near the interior and exterior side of the doors, but is lacking the lower access button required by current code. These entry doors have any ADA International Symbol of Accessibility (ISA) symbol sign indicating accessibility, but proper code compliant accessibility is not actually provided.

The main entry is accessed via a sloped walkway, as well as stairs with hand rails. Due to the sloping site conditions, there are multiple doors leading directly from the interior to the exterior of the building. Although these doors do have interior exit signs, they do not have any ADA visual, tactile or Braille door identification signs on the exterior side. No exterior site wayfinding signs directing the user from these doors to the front entrance of the building are present either.

The west side of the building does have updated compliant interior room identification signs at the doors, but the east side does not. The student and staff restrooms on the east side of the building are also lacking compliant signage.

Once inside the building, there approximately twelve (12) doors on the upper level, and six (6) on the lower level that do not meet the minimum push/pull side dimensional clearances, and are thus not accessible. A few of these non-compliant push/pull conditions exist at exit doors. Additionally, the pair of emergency exit doors in corridor 112A are blocked off with tape, indicating they are not to be used.

An elevator provides access to both levels, but lacks a verbal annunciator to announce the floor at which the car is stopping, and no elevator wayfinding signage is in place.

The open staircase leading from the main building Lobby to the Library, lacks the required upper and lower visual warning stripes at the stair nosings, and the handrails heights and returns are not compliant. Interior Stairwells 136 and 147 also have non-compliant handrail heights and returns, and the minimum 44" stairwell width is not provided at either location.

Stairway exiting signage is also inadequate at all levels. Tactile identification signs identifying the floor level, stair level and exit level are non-existent. Stairwell doors leading to the exterior do not have properly illuminated nor ADA tactile signs.

Four of the five drinking fountains in the building do not provide adequate maneuvering clearances, are not in alcoves and are without guardrails. Three of the five fountains are required to be hi-low accessible drinking fountains, and therefore the building does not meet the 50% ratio required by code, and accommodations should be provided.

The building does not provide an ADA compliant staff restroom.

## **8. Inspector's Notes**

The west wing of the LRC building has been modernized, continues to be generally well maintained, is fully functional for its intended uses, and closely reaches the level of other college and educational buildings of this type. The east Library wing is poorly maintained and does not reach the level of other college and educational buildings of this type. A modernization of entry access, floors, walls, ceilings, lighting, mechanical, plumbing and electrical systems is recommended.

The surrounding site is in need of modernization to be brought up to current ADA accessibility codes.

There are debris and storage items blocking the minimum clear working space around all mechanical and electrical indoor equipment. These items should be relocated immediately to increase building safety, eliminate fire hazards and provide code required minimum clear working spaces. Additionally, there are few locations in the Library where duplex outlets are damaged and in need of repair, as they pose potential hazards.

## **9. Summary**

The existing east wing Library space of the combined LRC building occupies approximately 34,500 sf of the entire 52,335 sf facility. All of the systems, furnishings, fixtures and finishes in this wing are dated, extremely worn and damaged, are no longer aesthetically pleasing, and have reached the end of their useful life. The use and layout of the Library space also requires re-configuration, not just replacement of finishes, and would benefit from a significant modernization to improve the building's performance and match the quality and life-cycle of the west wing Learning Center finish materials.

Three sides of the building have outdoor plazas with a garden, benches, pole lighting and a bicycle repair area. The doors exiting into these spaces are without signage, the pavement has deteriorated expansion joint materials, and the sites are dimly lit. These areas would benefit from site improvements to provide better circulation, and encourage user interaction.

The building exterior circulation does not provide a compliant path of travel to the main building entrance, nor other ancillary exits. Handrails and walking slopes should be renovated to be made accessible.

# **APPENDIX A BUILDING PLANS**



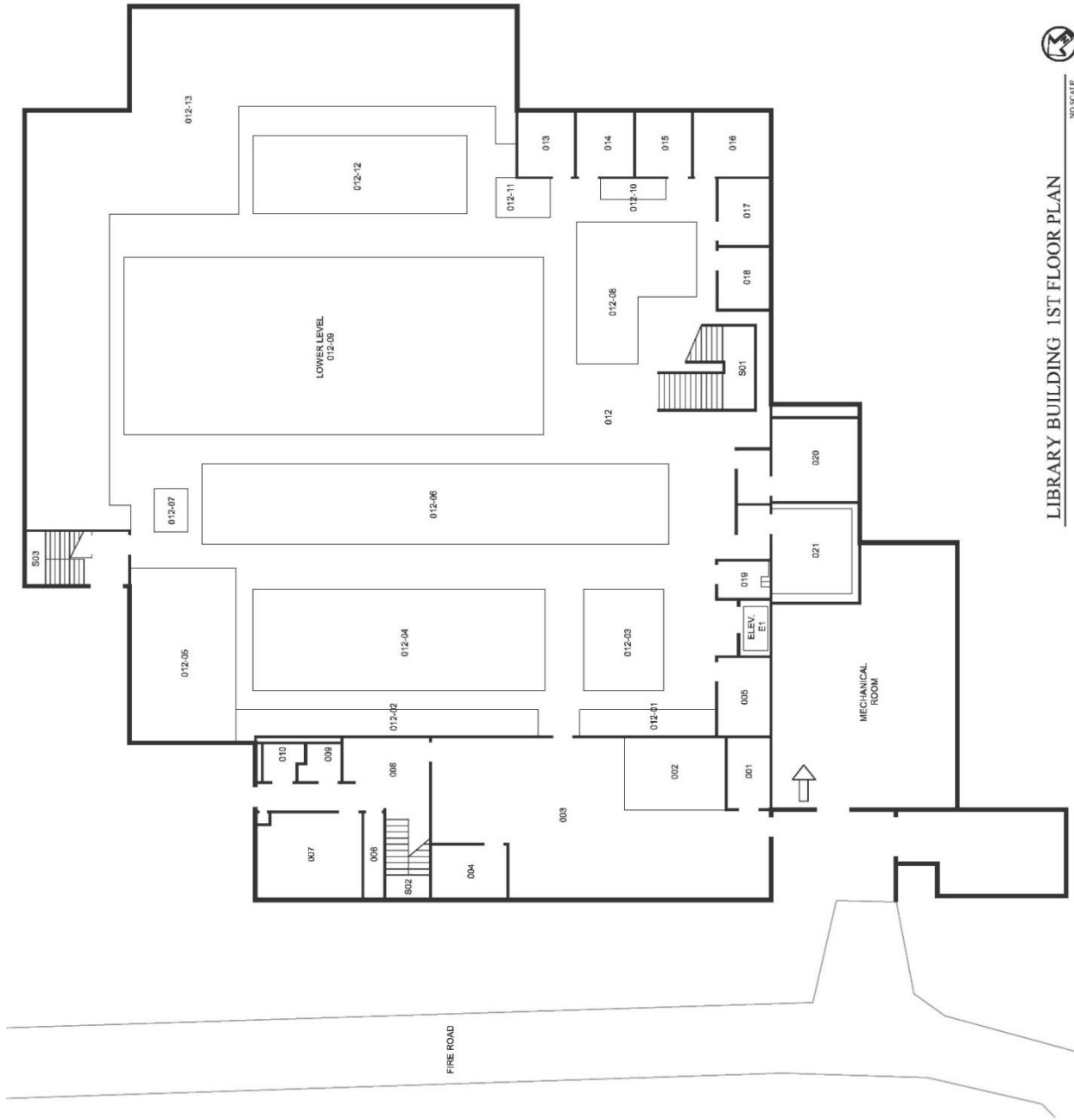

NO SCALE

LIBRARY BUILDING 1ST FLOOR PLAN

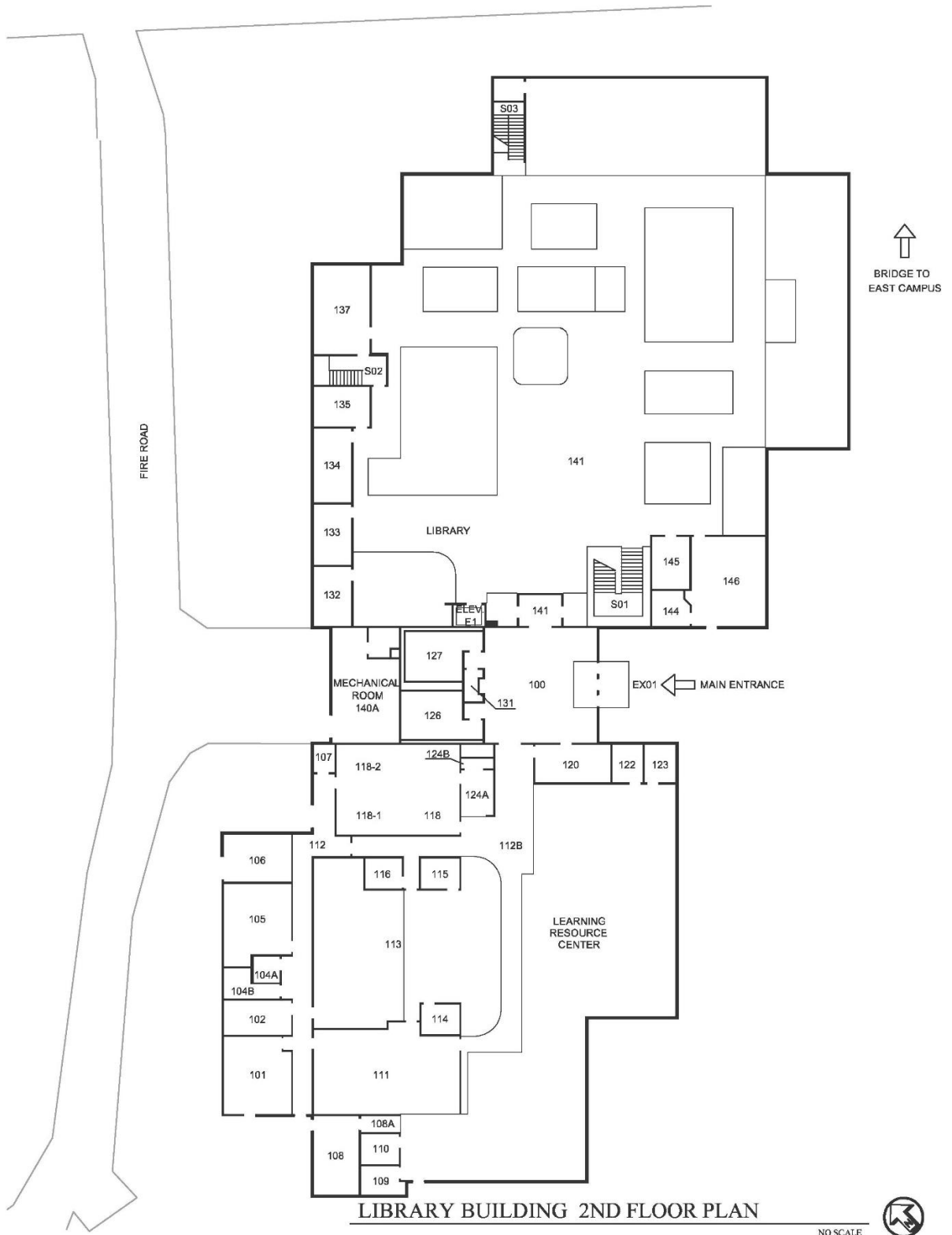

LIBRARY BUILDING 2ND FLOOR PLAN

NO SCALE



# APPENDIX B

## PHOTO LOG and NARRATIVE

1. Architectural
  - a. Exterior
    - 1) Wall Finishes
    - 2) Roof Systems
    - 3) Entrances/Doors
    - 4) Windows
    - 5) Floor Finishes
  - b. Interior
    - 1) Wall Finishes
    - 2) Ceiling Systems
    - 3) Doors
    - 4) Floor Finishes
2. Building Systems
  - a. Mechanical
  - b. Electrical
3. Accessibility
  - a. Restrooms
  - b. Drinking Fountains
  - c. Stairs
  - d. Elevators
  - e. Signage
  - f. Path of Travel

## EXTERIOR

- Wall finishes



AE1. Exterior walls, minor plaster cracking.



AE2. Cracked and bubbling plaster at south entry column.

## EXTERIOR

- Roof Systems



R1. Metal awning damage, northeast side of building.



R2. Roof tile mortar damage at ridge, northeast side of roof.



R3. Skylights over Library east side.



R4. Built-up roof system in good to excellent condition. Flood lights serve to light the walkways and plazas below.

## EXTERIOR

- Entrances/Doors



D1. Main Entrance; doors do not provide code required pull-side clearances, and wall mounted door identification signage.



D2. Main Entrance; low level access button for electronic door operator not provided.



D3. Doors to stairs, at lower level; lacking code required wall mounted door identification signage.



D4. Doors on east side of building; lacking code required wall mounted door identification signage.



## EXTERIOR

- Windows



EW1. Exterior windows first level, in good condition.



EW2. Exterior upper level windows, in good condition.

## EXTERIOR

- Floor Finishes



EF1. East side concrete walkway, with large cracks, tripping hazards and excessive cross slope.



EF2. South side concrete walkway, with excessive longitudinal slope and deteriorated expansion joints.



EF3. Concrete walkway, with tripping hazard ground down.



EF4. Main south entrance walkway; stained pebbled finish surface.

## INTERIOR

- Wall finishes



A1. Learning Center interior wall with minor damage.

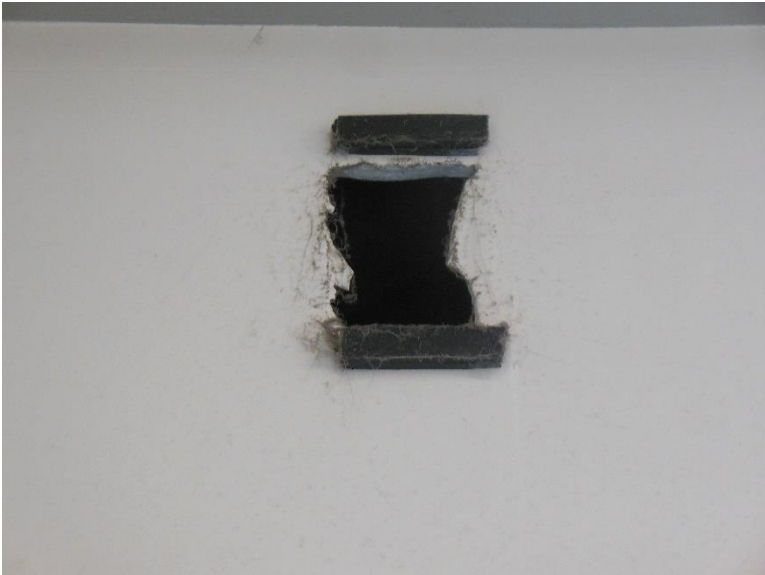

A2. Lobby interior wall with hole.



A3. Library vestibule; wall damage.



A4. Library vestibule;  
fabric wallcovering stained.

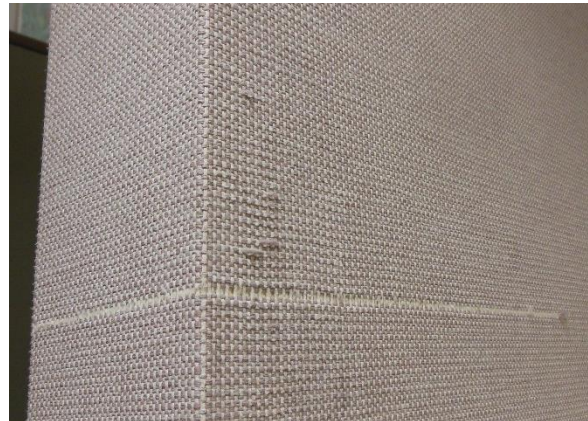

A5. Library upper floor;  
fabric wallcovering damaged.



A6. Library south side; lower level window sill vandalism and damage.



A7. Library lower level; wall damage.

## INTERIOR

- Ceilings Systems



C1. Corridor 112B; missing ceiling tile.



C2. Library second floor; stained ceiling tile.



C3. Library upper floor; broken/damaged ceiling tiles.



C4. Library upper floor; stained ceiling tiles at elevator.



## INTERIOR

- Entrances/Doors



D1. Learning Center area non-compliant exit; side clearance not provided, vision light too high, and exit sign not illuminated.



D2. Lobby Men's Restroom; damaged paint, and non-compliant door signage.



D3. Office 121; damaged frame at door lite.



D4. Men's Restroom, 2nd floor; door and wall ADA signage not provided.



D5. Lobby main doors; non-compliant push-side clearance. Electronic door operator low level access button is required by code.



D6. Exit doors, Corridor 112A; exit access blocked with tape.



D7. Exit door, Corridor 008, push-side clearance not provided.

## INTERIOR

- Floor Finishes



IF1. Learning Center carpet tile and wood base in excellent condition.



IF2. Learning Center carpet tile and rubber base in excellent condition.



IF3. Lobby rubber tile and rubber base with water damage at drinking fountains.



IF4. Corridor 112; original VCT and rubber base in poor condition.



IF5. Corridor 112; original VCT and rubber base in poor condition.



IF6. Library vestibule; resilient base in very poor condition.

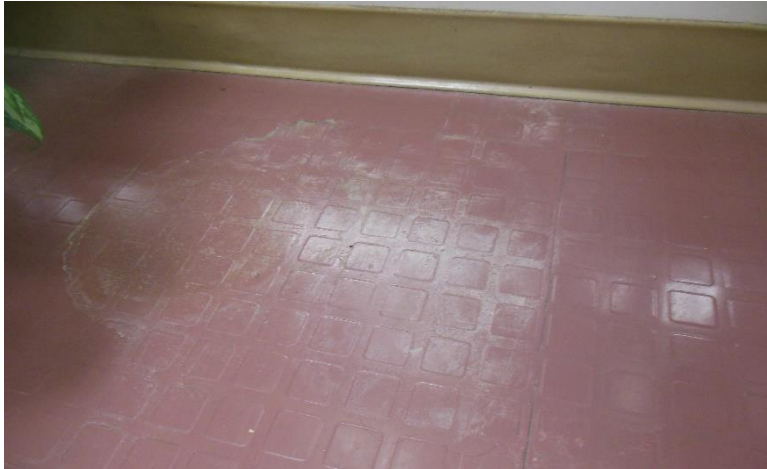

IF7. Library vestibule; rubber floor in very poor condition.



IF8. Library Café, upper floor; resilient cove base in very poor and unsanitary condition.

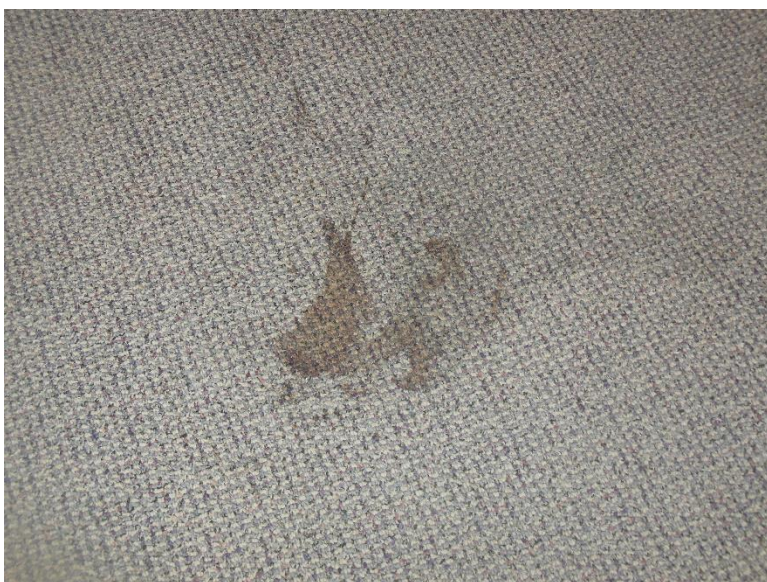

IF8. Library; broadloom carpet with stains throughout, typical.

## BUILDING SYSTEMS

- Mechanical



M1. Chiller enclosure. One unit is in use and in good condition.



M2. Mechanical equipment blocked by debris.

## BUILDING SYSTEMS

- Electrical



E1. Electrical equipment lacking clear floor space required by code.



E2. IT and Fire Alarm equipment.



E3. Women's Rstroom 126; lighting fixture lens.



E4. Library, first floor; electrical light fixture connection.

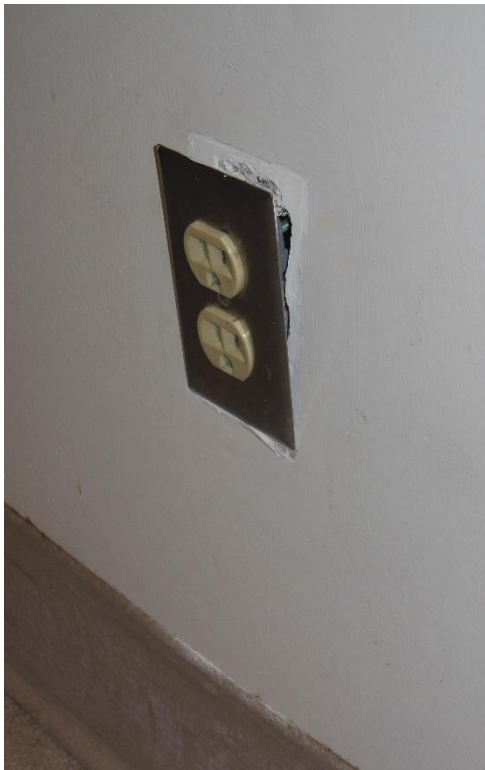

E5. Library, first floor; electrical duplex outlets, poor condition/installation.



## ACCESSIBILITY

- Restrooms



RR1. Women's Lobby restroom. Door finish repair required. Low level access button for electronic door operator is required by code, and ADA door signage is non-compliant.



RR2. Women's Lobby Restroom. Dispenser and disposal units protrude into required clear space below handrail.

## ACCESSIBILITY

- Drinking Fountains



DF1. Lobby; water bottle filling station and drinking fountain.



DF2. Second floor restrooms; non-compliant hi-low drinking fountains.



DF3. Corridor 112; non-compliant hi-low drinking fountains.



DF4. Top of Stairwell 147; non-compliant hi-low drinking fountains.



DF5. Top of Stairwell 136; non-compliant hi-low drinking fountains.

## ACCESSIBILITY

- Stairs



ST1. Library main interior staircase; ADA signage missing.



ST2. Library interior stairs; upper and lower visual warning stripes missing at stair nosings. Rubber treads worn and damaged.



ST3. Stairwell 136; non-compliant handrail heights and returns.



ST4. Stairwell 136; minimum stairwell width of 44" is not provided.

## ACCESSIBILITY

- Elevators



EV1. Library; first floor elevator entrance.



EV2. Elevator interior cab controls.



EV3. Inside elevator cab; floor indicator lights not operating.



EV4. Elevator floor Braille sign at jamb.

## ACCESSIBILITY

- Signage



S1. Learning Center; ADA compliant exiting signage.



S2. Evacuation maps provided at west side of building, not east.





S3. Library restrooms, second floor.  
Women's and Men's non-compliant wall signage.



S4. Library, lower level; exit sign not illuminated,  
and excessively high for visibility.

## ACCESSIBILITY

- Path of Travel



PT1. Non-compliant path at southeast side of building.

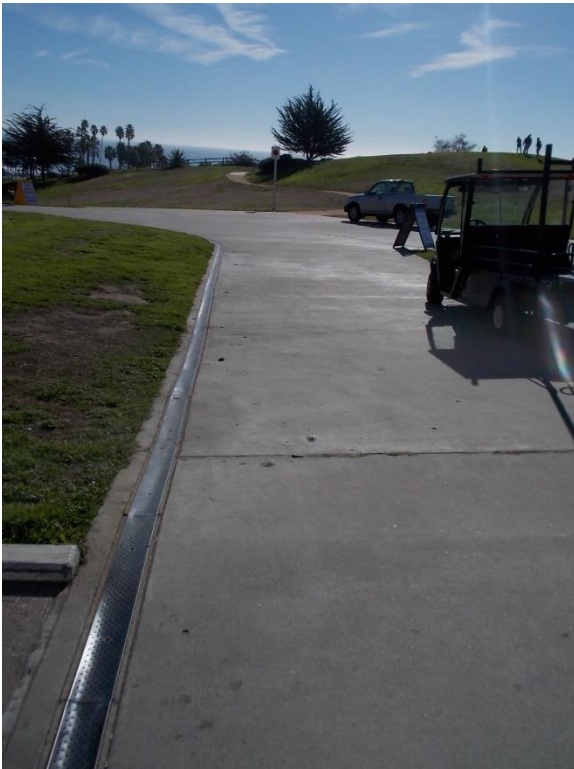

PT2. Non-compliant path at southwest side of building.



PT3. Main entrance, south side.  
Intermediate handrail at stairs required.



PT4. North side of building; non-compliant asphalt ramp.

# **APPENDIX C EXISTING BUILDING DETAILS**

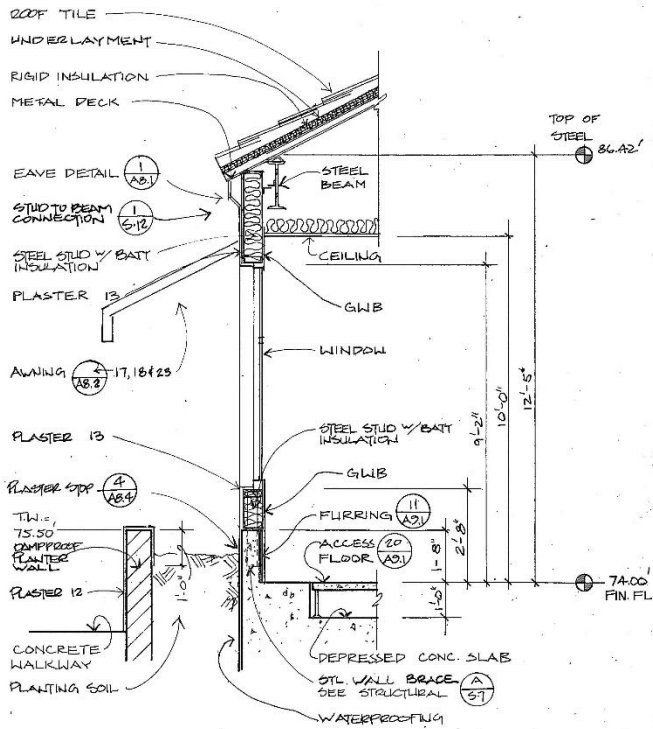

**WALL SECTION**

1/2" = 1'-0"

4

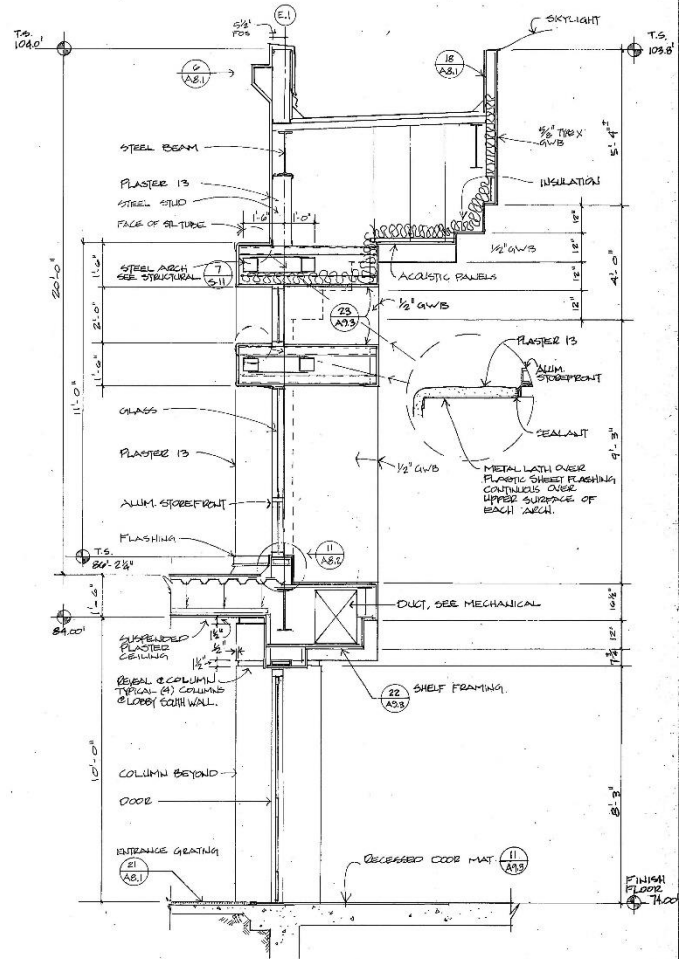

**WALL SECTION**

1/2" = 1'-0"

4

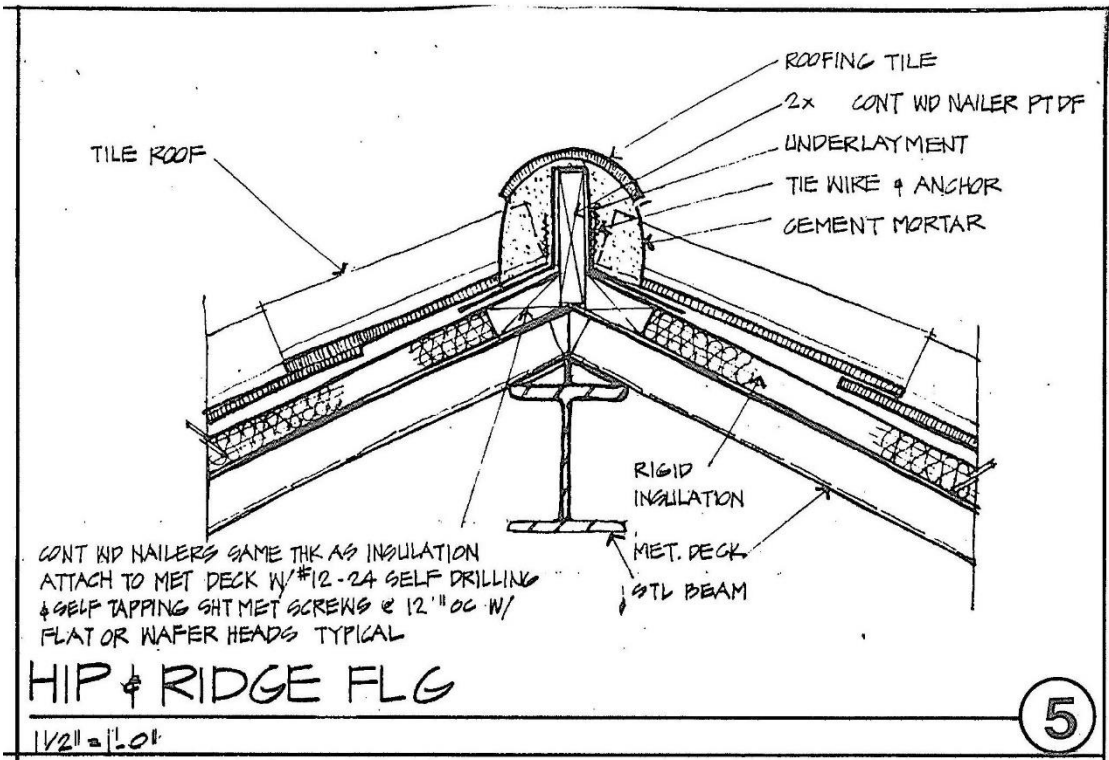
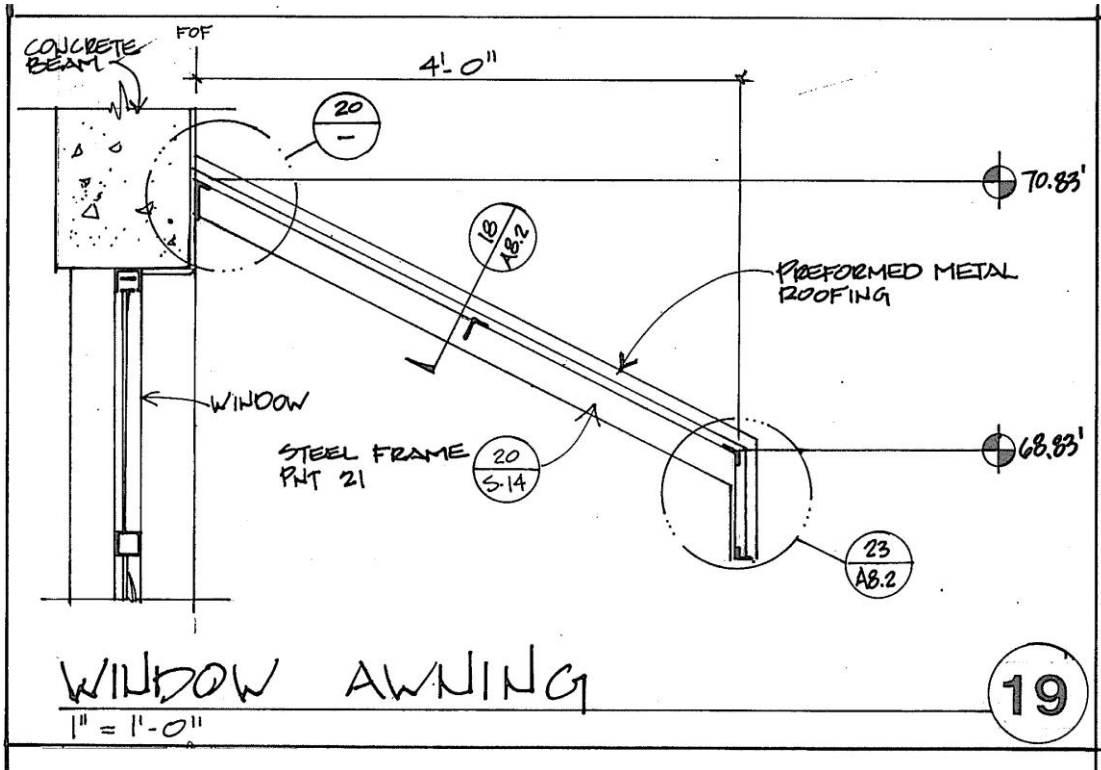

# Facility Condition Assessment Report STUDENT SERVICES

*Prepared for*



## **SANTA BARBARA CITY COLLEGE**

**Santa Barbara City College – Main Campus  
721 Cliff Drive  
Santa Barbara, CA 93109**

RJC Project No: 2015.46



*Prepared by*  
**RJC Inc.**

**Facility Condition Assessment Report**  
**Santa Barbara City College – Main Campus**  
**Student Services**  
**721 Cliff Drive**  
**Santa Barbara, CA 93109**

March 4, 2016

---

---

*TABLE OF CONTENTS*

*Description*

*Number*

*Page*

1. Facility Description	2
2. Major Findings	3
3. Site Findings	4
4. Architectural Findings	5
5. Mechanical Findings	6
6. Electrical Findings	7
7. ADA Building Descriptive Report	8
8. Inspectors Notes	9
9. Summary	9

*Appendix*

A. Building Plans	10
a. First Floor, and Basement	11
b. Second Floor	12
B. Photo Log and Narrative	13-42
C. Existing Building Details	43-45



# **1. Facility Description**

Year Built: 1965

Square Footage: 43,038 sf

Construction type: V 1-hour and L

Occupancy: Mixed, B-2 (offices and education), A-3 (assembly)

This building was originally designed and built as a two story Library with a partial basement. In 1991, the center atrium was infilled, and a complete building renovation occurred to create the Student Services Center. The building houses student services and staff offices.

Modifications to the building include: 1975-76 Power/Lighting Modifications, 1975 Handicap renovations, 1989 Interior Addition, 1988 Roof Panel, 1993 Second Floor Office renovation, 1999 Flooring replacement, 2000 HVAC Modification/Addition, 2001 Electrical/Communications plan room 250, 2001 Re-Roof, and an elevator addition.

The construction includes concrete slab below grade with footings and foundation walls, concrete shear walls, pre-cast tilt-up concrete walls, steel moment resisting frame at the first story addition, light metal frame at the second story addition, and post-tensioned structural elements. The exterior walls are painted lath and plaster, and are set back from the column and high arced covered walkway roof overhang. The roof system is built-up roofing over poured in place concrete deck, with framed acrylic skylights, roof drains, and plaster covered parapets with a quarry tile trim roof edge. The main east entrance doors are wood panel, while all other exterior glazed doors and windows are part of an aluminum storefront system. Vertical circulation elements include an interior elevator, and interior and exterior stairways. Exterior entry stairs have precast concrete risers and treads with painted warnings strips.

The interior spaces have 2x2 and 2x4 suspended acoustic tile, painted gypsum board, and acoustic plaster ceiling systems. Wall types include CMU and wood and metal stud interior partitions, with finishes consisting of fabric covered wainscots, painted gypsum board and veneer plaster. Floor finishes include 9x9 Vinyl Asbestos Tile (VAT), carpet tile, rubber and resilient sheet goods, with rubber wall base. Restrooms have resilient, ceramic and terrazzo tile floors, with FRP and ceramic and terrazzo wainscots, rubber base, painted gypsum board ceilings and metal or plastic toilet partitions. Interior spaces incorporate plastic laminate and wood casework, built-in file cabinets, marker boards, and fabric covered tack boards. Interior doors are a combination of stained wood and plastic laminate in metal and wood jambs with updated electronic card reader hardware. The building is served by an elevator. The exterior windows are both operable and fixed, with aluminum and steel frames

The building does not have a fire sprinkler system, but fire alarm system consists of audible and strobe annunciators throughout the building. The system is activated by pull stations and smoke detectors and is centrally monitored by a Simplex panel, and connected to the campus wide fire alarm system. The building also has security alarm, and an AED unit in the first floor lobby, and all levels have fire extinguishers spaced appropriately.

All floors of the building have both men's and women's accessible restrooms in addition to water fountains. The restrooms have the original ceramic floor and wall tile, plumbing fixtures, ceilings and lighting.

## 2. Major Findings

Although selected rooms and areas have been renovated previously, in addition to carpet and wall base replacement, the building has not had an overall comprehensive renovation since the atrium space was infilled over 25 years ago.

- Ceiling systems - A portion of suspended ceiling system is original and in fair to poor condition. Many suspended ceiling tiles are stained, damaged, require replacement, and at various locations grid members are bent and require refurbishment. The grid finish is colored, adding to the dated appearance. Additionally, the suspended ceiling system components such as: suspension hanger and bracing wire types and attachments, compression posts, main and cross runners, splices, expansion devices, intersection connectors, fire rating, and total system weight, likely no longer meet current ASTM ratings, the CBC, nor Department of the State Architect (DSA) requirements.
- Flooring - Areas which received new carpet tile and base remain in good condition. The resilient flooring green colors are dated and the finish conditions are stained, worn, and should be replaced. The basement area has the original 9x9 VAT which is badly damaged and exposed. Remediation and abatement at this damaged material is recommend now, as well as during any future renovation.
- Walls - The building has a variety of wall materials, most of which are in fair condition. The finish materials are damaged and stained, and require repainting or refurbishing. The fabric wall covering wainscot is stained, damaged, dirty, and should be replaced with a more durable material.
- Doors - The wood door stain and lacquer finishes show wear and should be refinished. The exterior pair of doors leading into the Disabled Student Programs and Services testing lab, does not have a compliant threshold. Doors with electronic door openers do not provide the code required lower-level push plates.
- Restrooms - Student restrooms are on both the first and second floors, while staff restrooms are only on the first floor. All floor finishes, colors, fixtures and equipment are in poor condition, with water leaks apparent and causing finish damage and staining. Plumbing piping has been replaced and/or rerouted, leaving unrepaired holes in the ceramic wall finishes. Metal partitions are rusted and should be replaced. ADA restroom door signs are non-compliant with current codes. Although the layouts and configurations of the student restrooms are somewhat efficient, these were originally designed to meet earlier ADA standards, and should be re-evaluated for compliance to current ADA codes. Staff restrooms do not meet dimensional requirements for a single occupancy restroom.
- Drinking Fountains - The building has drinking fountains on both floors, but building does not meet 50% ratio code requirement of hi-low accessible drinking fountains. One fountain has been replaced by a bottle filling station, and the alcove does not provide adequate wheelchair clearances. Fountains that splash and leak have caused water damage and staining on the flooring beneath.
- Life Safety Systems - The fire alarm system was upgraded and certified by the Department of the State Architect (DSA) in 2015 and requires no further work.

### **3. Site Findings**

The building sits on a flat site, however, adjacent exterior spaces are a lower elevations.

The site surrounding the building consists of plazas, paved walkways, ramps, stairs, and minor landscaping. The walkways on the north and west sides of the building are covered by a wood painted Pergola which provides minor shading. The concrete walkways around the building, which are intended to be the accessible path of travel, are very uneven, cracked, have abrupt changes in level, expel the user into the fire lane, have excessive cross and longitudinal slopes, and lead to excessively steep sidewalks.

Cars and carts park in the paved plaza on the east side of the building, creating unprotected vehicular influences with pedestrians. The plaza on the west side of the building is paved, shaded, and provides areas to sit.

Each side of the building has a separate entrance, which are accessed by walks, stairs, and ramps. These ADA ramps have excessive running slopes and include non-compliant handrails. The building occupancy dictates an additional middle handrail is required at the stairs leading to the main east building entrance. The handrails at the exterior staircases leading to the second floor exceed the height allowed by code.

The intended accessible path of travel to the building from the accessible parking stalls in Lot 1A is not clearly marked, curb ramps have non-compliant slopes and are missing truncated domes at the vehicular influences, and the concrete pathways are uneven and have tripping hazards.

Adjacent to the Student Services Building, an outdoor staircase leads down to Pershing Park. This staircase has open risers which are not permitted in ADA standards. A second well used concrete staircase, located at the northeast corner of Lot 1A, provides access to the campus from the public sidewalk on Cliff Drive below. The landings are not level throughout this staircase, and the stair nosings do not have adequate visual warning stripes. Security surveillance cameras are positioned along this route, but signs indicate the cameras are not monitored live. There is an emergency phone with blue lights on top in Lot 1A.

The path of travel from the adjacent public transportation bus stop on Cliff Drive to the Student Services building is not ADA compliant. There are excessive cross and longitudinal slopes, multiple abrupt changes in level and/or hazardous surface features, non-compliant curb ramps, and no level landing at the sidewalk location to board the bus. Curb ramps in this area are also non-compliant.

## ***4. Architectural Findings***

The following architectural items were discovered during the assessment:

**ROOF:** Roofing was replaced in 2001 and appears to be in good condition.

**CEILINGS:** The ceilings in the facility are the original suspended acoustic tile and plaster ceiling systems. Many lay-in tegular ceiling tiles are stained, damaged, require replacement, and at various locations grid members are bent and require refurbishment. The suspended ceiling system may no longer meet current code requirements and regulations, has not been upgraded, and would greatly benefit from refurbishing

**WALLS:** The exterior painted plaster wall finish is in overall fair condition, with various locations of peeling paint and hairline cracks that require repair and repainting.

Interior walls are painted gypsum board, veneer plaster, and painted concrete. Numerous walls, wall corners and wall finishes throughout the building are damaged and need repair. The basement gypsum walls have water damage and require renovation. Restroom ceramic wall finishes have holes, are stained, and require repair. Ceramic tile is mismatched at areas of previous repair. Fabric covered wainscots are stained and require removal or replacement. Multiple corridor corners and column edges are damaged, require repair, and could avoid further damage with the installation of corner guards.

**FLOORING:** Although the carpet tile and most rubber base throughout the building is in very good condition, areas with resilient flooring show wear and damage, and would benefit from replacement, specifically in the basement. Ceramic and terrazzo restroom floors are very dirty and dated and should be renovated. The surrounding concrete walkways have numerous uneven surfaces, cracks, non-compliant slopes, and should be repaired.

**RESTROOMS:** The restrooms have the original colors, finishes, and fixtures, which would benefit from a modernization to meet the lifespan of the building. Multiple toilet partitions are rusted and vandalized and should be replaced with products better suited to withstand significant wear and use. The layouts require reconfiguration to meet current accessibility codes for dimensional clearances.

## **5. Mechanical Findings**

The Student Services building mechanical system consists of two air cooled Trane 40 ton chillers in an exterior enclosure adjacent the parking lot, and one gas fired boiler in the basement inside the building. It is a four pipe hydronic system, and heating and cooling is provided by air handlers with ducted distribution. There are two AHUs on the second floor serving the first floor, split between north and south (not including the atrium in-fill area). The exhaust system with air distribution in the basement, serves the electrical room, restrooms and storage. In 1989 one rooftop AHU was added. The boiler was replaced in 2006, and the chiller in 2007.

Plumbing fixtures are original, using copper piping that was replaced in the 1991 renovation. Domestic hot water is provided by a 40 gallon gas water heater and a 6 gallon electric water heater.

The chillers, boiler, exhaust system, ducting, piping, piping insulation, disconnects, pumps, valving, controls and accessories are at the end of their useful life and should be replaced. These units use obsolete R-22 refrigerant, and asbestos may be present in the basement.

The belts, filters and motors are a regular, ongoing maintenance issue.

Some rooftop exhaust fans are original and some have been replaced on an as needed basis.

There are debris and storage items blocking the minimum clear working space around all mechanical indoor equipment.

All equipment was properly marked. Rooftop units, piping and curbs meet minimum clearances, supports are secured to the structure, properly seismically restrained, and vibration isolation is present. The disconnecting means are present, in good working order, and are in-site and readily accessible. Exterior ducts are protected by a weatherproof barriers, and duct smoke detectors were present. The outside air intake vent distances and air inlet screen protection are in place. The exhaust discharge clearances to walls, roofs, operable openings and grade are within code requirements. Rooftop condensate lines discharge flows to drains connected to sewer system. Refrigerant pipe and tubing are compliant and refrigerant detectors are present. Boiler shutoff valves are present in the supply/return piping. Pipe hangers/ anchors/supports are within proper spacing.

## **6. Electrical Findings**

The electrical system is fed from a 4.8 KV 200 amp switch to a 225 KVA pad-mounted transformer that delivers 120/208 V., and a 225 KVA transformer providing 277/480V., 3-phase, 4-wire power to the facility. Interior lighting is typically fluorescent fixtures with motion sensors. Emergency lights are present and illuminated emergency exit signs are installed at the main exits. The building does not have an emergency generator.

The main electrical switchgear is located in the basement and was installed in 1989. The switchgear appears in good condition, yet the typical lifespan is 25 years, and thus has reached the end its useful life and should be replaced. There are indoor substations located throughout the building. Around the main switchgear are were debris and storage items blocking the minimum clear working space.

Service Disconnecting Means are present, in good working order, are in-site and but are not readily accessible as there are debris and storage items blocking the minimum clear working space in front of electric equipment. Ground Fault Protection and grounding electrodes are present and appear in good working order. Electrical panels have circuit directories, but it is unknown if the directories are up to date. Energy efficient lighting for interior and exterior are being upgraded on an on-going basis. Life-safety elements and emergency lighting are present. Adequate illumination of interior and exterior spaces appears to be present, but indoor and outdoor lighting fixtures are older and may not meet current Title 24 code requirements.

## ***7. ADA Building Descriptive Report***

All building entries are intended to be the wheelchair accessible entrances, but the site lacks an adjacent compliant access ramp to access the entry level at the doors. The ramp running slopes are excessive and the handrails too short.

All entrances have automatic door openers, but when not activated the doors are heavy, difficult to open, and exceed the opening force allowed by code. The electronic door operator lower-level push plates, now required by code, are not provided.

Once inside the building, the corridor widths are compliant, but some doors do not offer adequate dimensional push/pull side clearances. An elevator provides access to all levels but has no verbal annunciator to announce the floor at which the car is stopping.

Exit doors are marked with the proper illuminated signage, but lack proper Braille and tactile exit signs.

Although the building does have updated compliant interior room identification signs, it lacks extensive interior directory, wayfinding and evacuation signs, as well as exterior visual, tactile or Braille door identification signs.

Stairway exiting signage is non-existent at all levels. Tactile identification signs identifying the floor level, stair level and exit level are non-existent. Stairwell doors leading to the exterior do not have ADA tactile exit signs.

There are three single-station drinking fountains in the building, but none are the hi-low type. One fountain is a bottle filling station in an alcove, and does not provide adequate side clearances. Two of the three fountains are required to be hi-low accessible drinking fountains, and therefore the building does not meet the 50% ratio required by code, and accommodations should be provided.

## **8. Inspector's Notes**

The building has been generally well maintained, but is not fully functional for its intended uses. It is in need of a modernization to be brought up to the level of other college and educational buildings of this type. This building is salvageable and is recommended for modernization versus replacement. A modernization of floors, walls, ceilings, HVAC, plumbing, lighting, and signage is recommended.

The basement has recently been flooded, and the damage to the floors and walls remain. It is highly recommended this area be further inspected and hazardous materials remediated.

A seismic study was conducted in 1996, with findings that indicate deficiencies are observed, but not significant enough to adversely affect life-safety performance of the building. Some exterior sheer walls and roof overhangs show hairline shrinkage cracks.

The surrounding site and building entrances are in need of modernization to be brought up to current ADA accessibility codes.

There are debris and storage items blocking the minimum clear working space around all mechanical and electrical indoor equipment. The items should be relocated immediately to increase building safety, eliminate fire hazards, and provide code required minimum clear working spaces.

## **9. Summary**

This existing building has not had a major modernization since the atrium space was infilled in 1991, when the facility use was converted from the Library to the Student Services Center. The atrium infill project created a disjointed layout, with gaps at new walls abutting existing arches, wide metal floor and overhead plastic expansion joint covers, and the revised second floor layout created ADA clearance issues at doors, and spaces without exterior light.

This is a heavily used building, and the existing ceiling system, resilient and ceramic flooring, wall and door finishes, casework and furnishing are dated, worn, damaged, are no longer aesthetically pleasing, and have reached the end of their useful life. These finishes and fixtures should be replaced with more durable, cleanable materials, and the entire building would benefit from a significant modernization to meet the quality and life-cycle of similar educational facilities.

All the basement finishes require restoration and should include hazardous materials clean up.

The surrounding exterior circulation route does not provide a compliant path of travel to the main building entrance, nor other ancillary exits. Signage, handrails and walking slopes should be renovated for proper accessibility.

The outdoor plazas and walkway areas have hazardous and abrupt changes in level, deteriorated materials, poorly marked entrances, and dimly lit exteriors. These areas would benefit from site improvement renovations to provide safer circulation, and create more inviting spaces for users to gather.



# **APPENDIX A BUILDING PLANS**

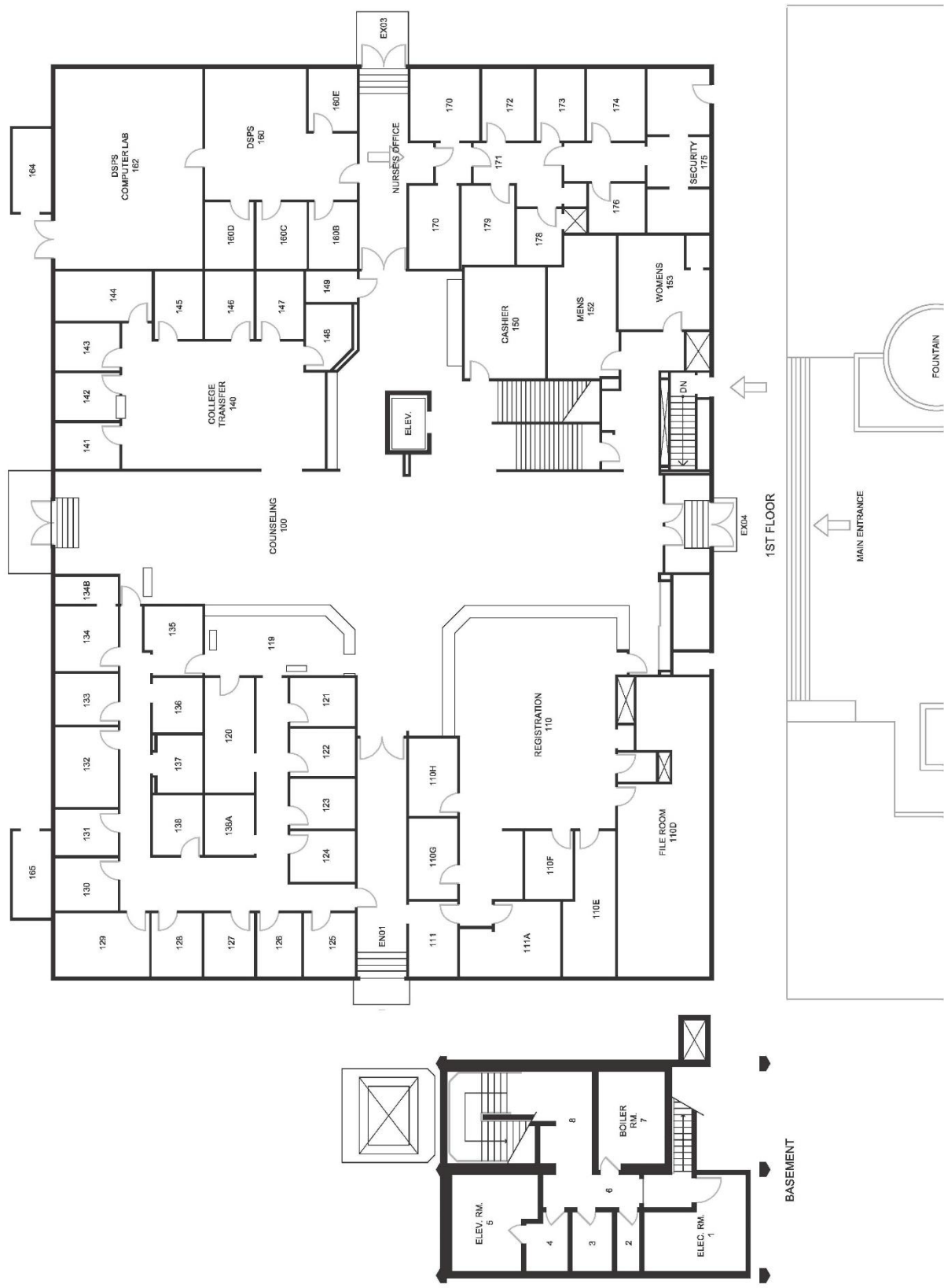

STUDENT SERVICES 1ST FLOOR PLAN / BASEMENT PLAN  
NO SCALE

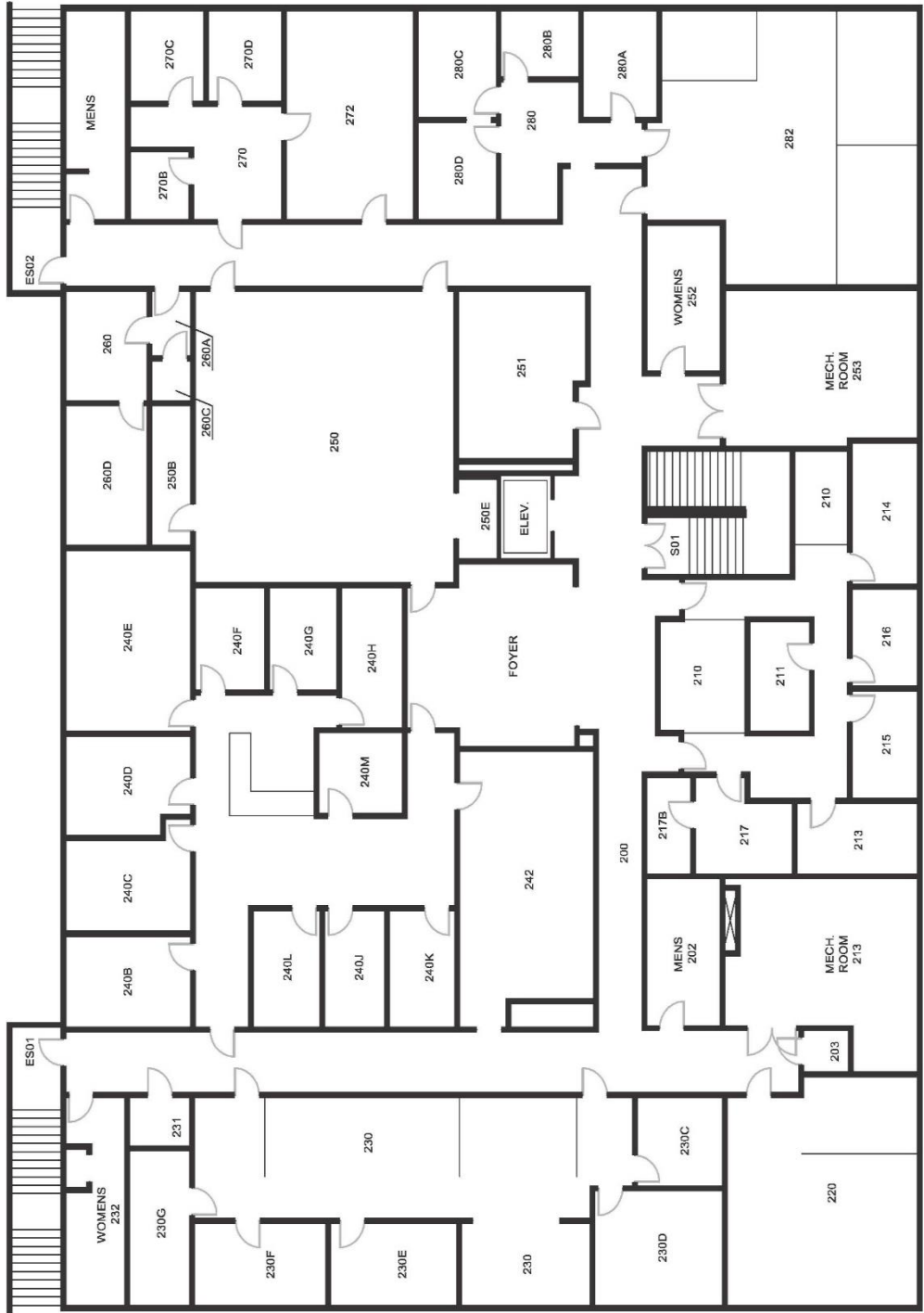

NO SCALE

STUDENT SERVICES 2ND FLOOR PLAN

# APPENDIX B

## PHOTO LOG and NARRATIVE

1. Architectural
  - a. Exterior
    - 1) Wall Finishes
    - 2) Roof Systems
    - 3) Entrances/Doors
    - 4) Windows
    - 5) Floor Finishes
  - b. Interior
    - 1) Wall Finishes
    - 2) Ceiling Systems
    - 3) Doors
    - 4) Floor Finishes
2. Building Systems
  - a. Mechanical
  - b. Electrical
3. Accessibility
  - a. Restrooms
  - b. Drinking Fountains
  - c. Stairs
  - d. Elevators
  - e. Signage
  - f. Path of Travel

## EXTERIOR

- Wall finishes



AE1. Exterior columns; peeling plaster paint.



AE2. Exterior walls; peeling plaster paint.



AE3. Exterior half wall; damaged plaster and paint.at corner condition.



AE4. Exterior wall; cracked plaster finish.

## EXTERIOR

- Roofs Systems

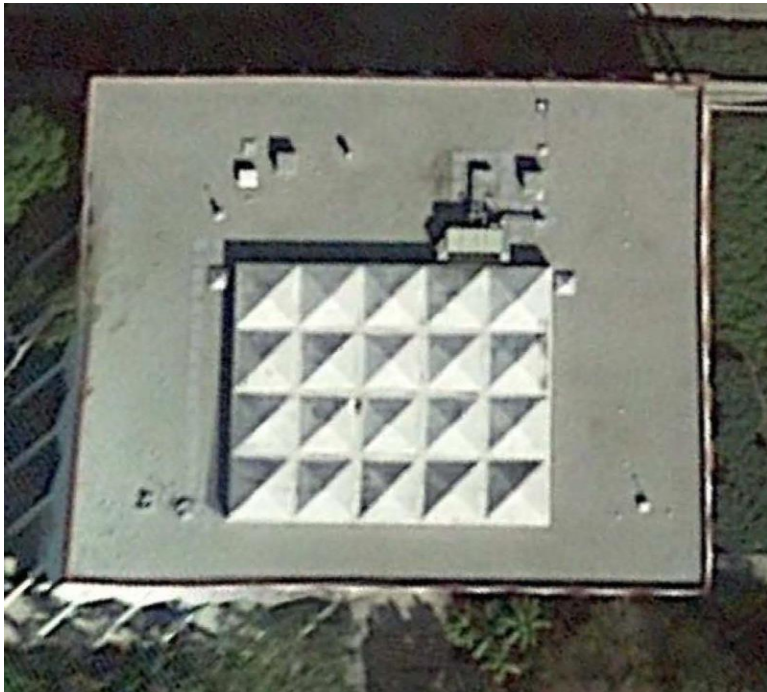

R1. Overall roof; built-up roof system, skylights and mechanical units.



R2. Exterior underside of roof overhang.

## EXTERIOR

- Entrances/Doors



D1. East side entrance; doors require excessive force to open, electronic door opener lower-level push plate not provided and ISA sign not installed.



D2. North side entrance; ISA sign not installed.





D3. DSPS Testing Lab; non-compliant threshold.

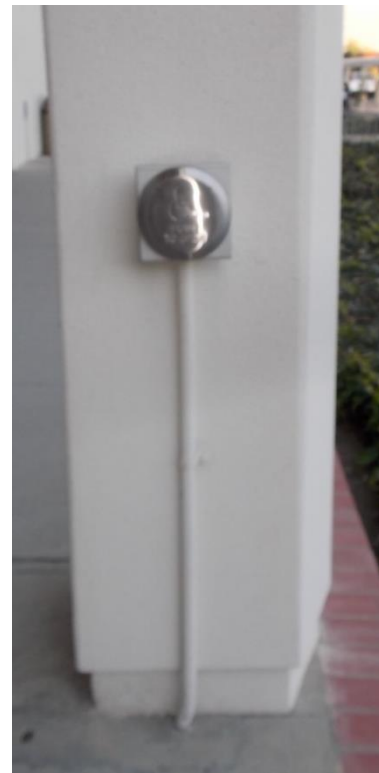

D4. South side entrance; doors require excessive force to open, electronic door opener lower-level push plate not provided and ISA sign not installed.



D5. Storage 164 door; damaged louver.



D6. West side entrance; door floor operator with exposed concrete.

## EXTERIOR

- Windows



EW1. Exterior windows.



EW2. Exterior storefront; east side.

## EXTERIOR

- Floor Finishes



EF1. Exterior walkway; abrupt changes in level.



EF2. Exterior walkway; cracked concrete, excessive slopes, and abrupt changes in level. End of walkway terminates into fire truck lane.



EF3. Northeast exterior walkway at top of ramp; cracked concrete.



EF4. North side entrance; cracked concrete walkway.

## INTERIOR

- Wall finishes



AI1. Basement; interior drywall and base damage.



AI2. Second floor corridor; fabric covered wainscot stains and corner damage.



AI3. Second floor Atrium infill space; awkward wall transitions.



AI4. Elevator cab interior; damaged wall panels.



A15. Wing wall damaged corner.



A16. Restroom wall tile mismatched.



A17. Men's Restroom accessible stall; ceramic wall finishes have holes, and graffiti on wall finish.



## INTERIOR

- Ceilings Systems



C1. Second floor Atrium infill space; building expansion joint cover.



C2. Second floor; ceiling tile damaged.

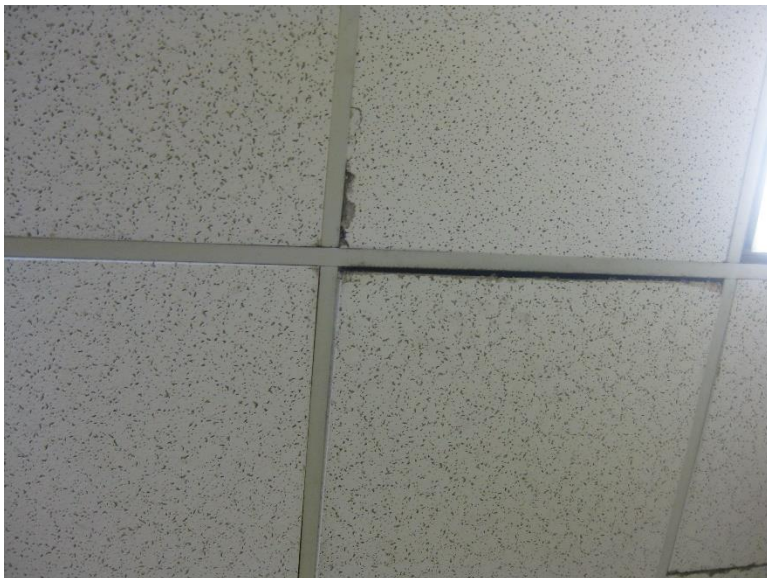

C3. Suspended ceiling tile; damaged.



C4. Suspended ceiling tile; stained.



C5. Second floor Women's Restroom; gypsum board ceiling stained.

## INTERIOR

- Doors



D1. First floor north east exit; electronic door operator low level access button required by code is not installed, and tactile exit signage not provided.



D2. First floor exit; electronic door operator low level access button required by code is not installed, and tactile exit signage not provided.



D3. Second floor exit to stairs; tactile exiting signage not provided.



D4. Second floor office; pull-side clearance not met.



D5. Second floor restroom; push-side clearance not met, wall signage missing.

## INTERIOR

- Floor Finishes



IF1. Second floor Atrium infill space; building expansion joint cover lifted, and rubber base damaged.



IF2. Second floor corridor; carpet tile, walk-off mat and rubber base in good condition.



IF3. Basement; base damage at wall and stair riser.



IF4. Basement; 9x9 VAT flooring damage.



IF5. Basement; 9x9 VAT flooring damage.

## BUILDING SYSTEMS

- Mechanical



M1. Boiler in basement.



M2. Mechanical equipment lacking clear floor space required by code.

## BUILDING SYSTEMS

- Electrical



E1. Electrical equipment.



E2. Electrical equipment lacking clear floor space required by code.



## ACCESSIBILITY

- Restrooms



RR1. Women's Restroom; wall mounted ADA signage and electronic door opener lower-level push plate not provided.



RR2. Sink does not provide paddle faucet fixture handles, knee protection is not provided at under sink plumbing traps.



RR3. Men's Restroom accessible stall; ceramic wall finishes have holes and dispenser mounting location interferes with the required clear space above side handrail.



RR4. Women's Restroom ambulatory stall; wall finishes have holes and dispenser mounting location interferes with the required clear space above side handrail.

## ACCESSIBILITY

- Drinking Fountains



DF1. First floor single drinking fountain; hi-low drinking fountain not provided and flooring damaged.



DF2. Bottle filling station/drinking fountain. Compliant maneuvering clearances not provided.

## ACCESSIBILITY

- Stairs



S1. Basement stairs; severely damaged materials, and non-compliant handrails.



S2. Exterior east stairs; lower handrail extensions are non-existent, gripping surface is too wide, the top and bottom landings have excessive slope and are not level.



S3. Interior staircase; stair nosings not contrasting, handrails not compliant, and stair signage not provided.



S4. Exterior northwest stair; stair nosing stripping faded, handrail heights and returns non-compliant.

## ACCESSIBILITY

- Elevators



EV1. Elevator access to all floors.



EV2. Elevator car interior.



EV3. Braille floor level sign.

## ACCESSIBILITY

- Signage



S1. Women's Restroom entrance; wall mounted room ID sign missing.



S2. Directory sign; no evacuation or other way finding signs are in the facility.

## ACCESSIBILITY

- Path of Travel



PT1. Exterior north ramp; non-compliant ramp. Handrails heights are too short, gripping surface is too wide, and ramp has excessive running slope. ADA directional signage is not provided.



PT2. Exterior walkway Pergola; non-compliant path of travel. Concrete surface is cracked, uneven and has excessive cross slopes. ADA directional signage is not provided.





PT3. Exterior sidewalk; non-compliant path of travel. Abrupt changes in level.

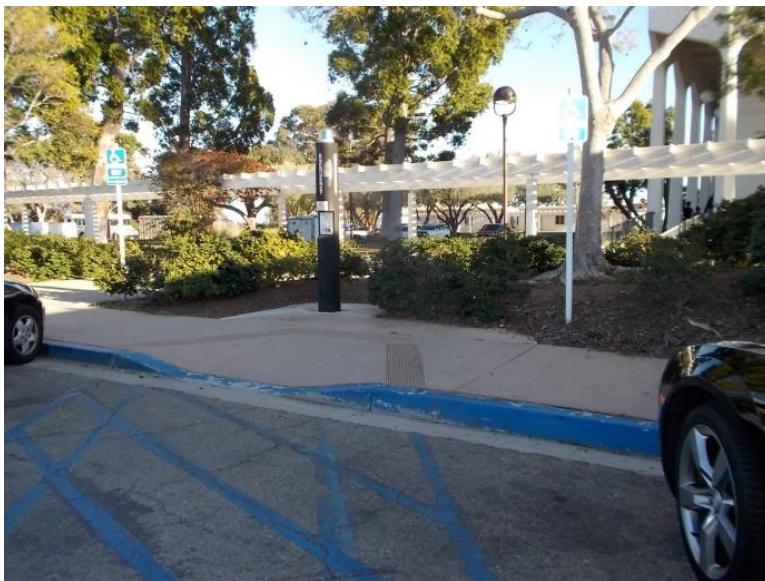

PT4. Non-compliant curb ramp. Truncated domes are not present, and top landing is not deep enough. The emergency phone also impedes into the clear space of the upper landing. Accessible parking stall stripping is faded and markings unclear.

# **APPENDIX C EXISTING BUILDING DETAILS**

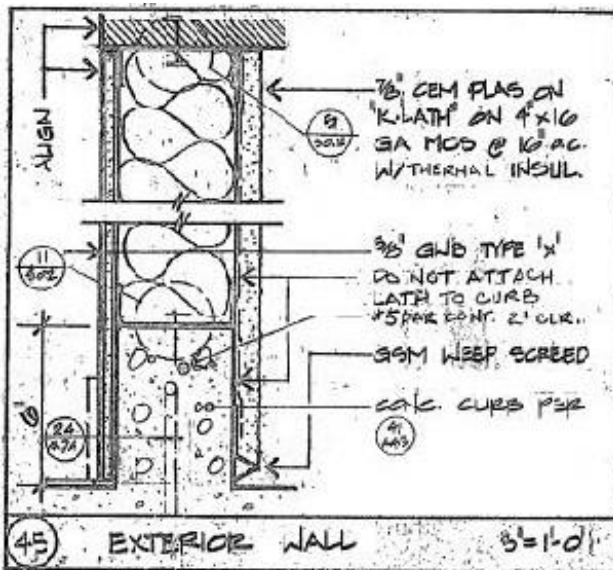
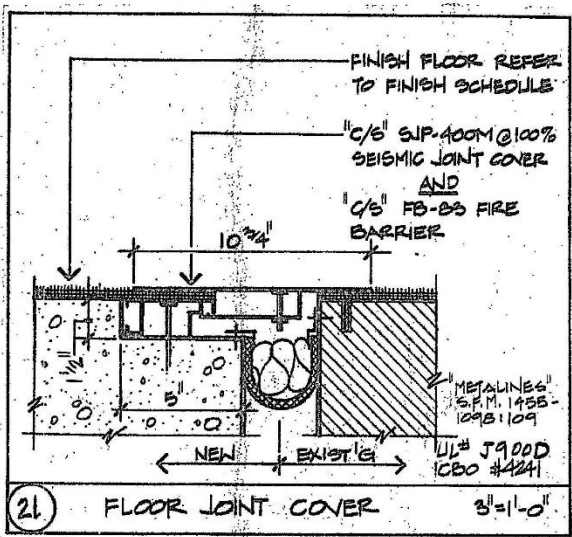
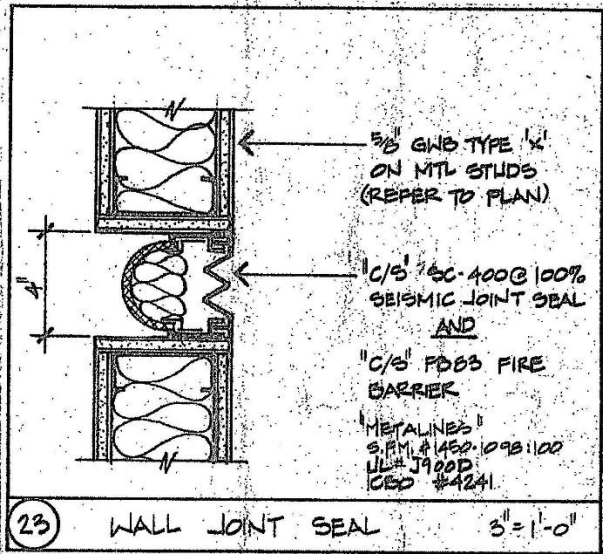
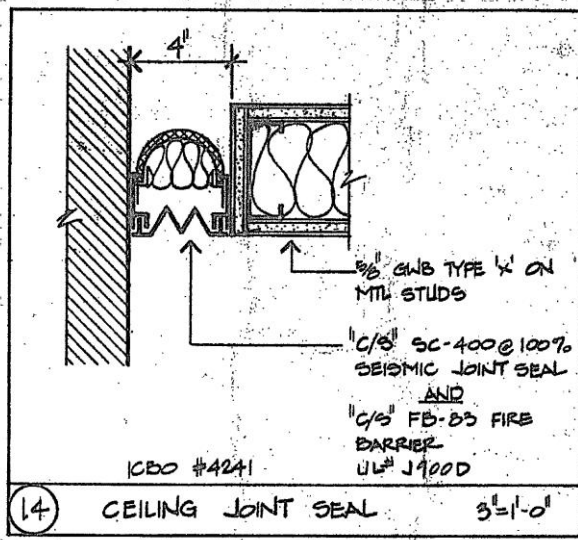

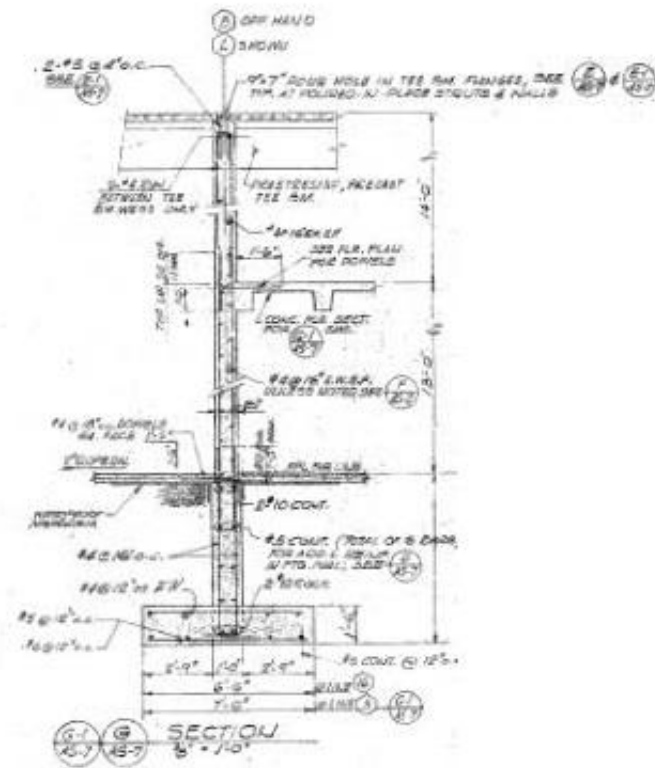
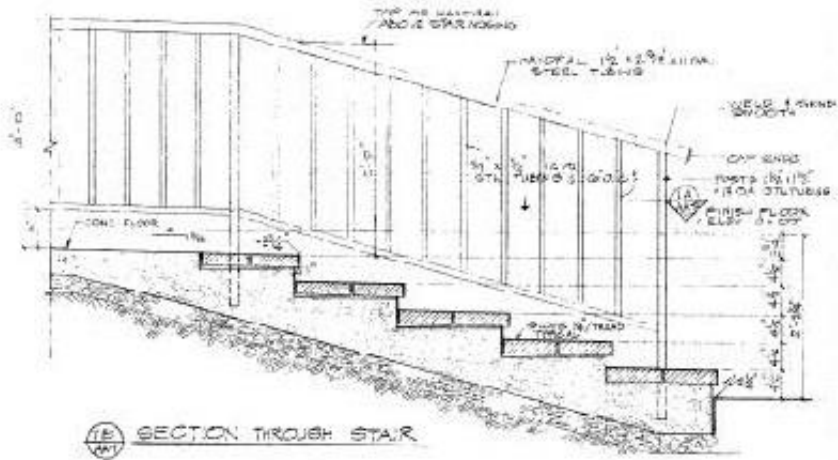

# Facility Condition Assessment Report WAKE CENTER

*Prepared for*



**SANTA BARBARA CITY COLLEGE**

**Wake Center  
300 North Turnpike Road  
Santa Barbara, CA 93111**

RJC Project No: 2015.46



*Prepared by*  
**RJC Inc.**

**Facility Condition Assessment Report**  
**Santa Barbara City College**  
**Wake Center**  
**300 North Turnpike Road**  
**Santa Barbara, CA 93111**

March 04, 2016

---

---

*TABLE OF CONTENTS*

*Description*

<i><u>Number</u></i>	<i><u>Page</u></i>
1. Facility Description	2
2. Major Findings	3
3. Site Findings	4
4. Architectural Findings	5
5. Mechanical Findings	6
6. Electrical Findings	6
7. ADA Building Descriptive Report	7
8. Inspectors Notes	8
9. Summary	8

*Appendix*

A. Building Plans	9
a. First Floor	10
B. Photo Log & Narrative	11-34
C. Existing Building Details	35-38

# **1. Facility Description**

Year Built: 1956

Floor Area: 44,600 sf

Construction type: Mixed occupancy, B-2 (offices and education), A-3 (assembly)

The Wake Center was originally built in 1956 as the Cathedral Oaks Elementary School, and is one of the College's two Continuing Education centers. The site currently includes 38,354 square feet of permanent buildings, 14,389 square feet of portable classrooms, and occupies approximately 9-1/2 acres. A large auditorium faces the entry parking lot, and adjacent classrooms and administration building surround a landscaped open space. The site is generally flat on the west side and slopes on the east. The permanent and portable buildings are surrounded by both paved and landscaped areas, offering several options to traverse the site using sloped walks and stairs.

The facility is located in a residential section of Santa Barbara County, approximately 10 miles north of the main campus with gas stations, commercial, restaurants and hotel lodging nearby. The facility is used by the "Adult Education" program offered through SBCC under the name of the Center for Lifelong Learning, serving both young and older students. Classes are in session during both the day and night, all year round, following the same school calendar as Santa Barbara City College.

The classroom buildings serve creative hands-on courses such as glass fusing, wood working, sewing, weaving, jewelry, computer and career skills, while the auditorium is used for fitness classes. A construction technology program is housed in two of the portable buildings.

The existing permanent buildings are one story with converted patio spaces, built with CMU and pipe column construction, slab on grade and concrete footings. The exterior building finish is painted CMU, and the built-up roof system has metal gutters and downspouts. A covered exterior corridor with concrete walkways follows the building layouts, with a central office and two-story auditorium and adjacent cafeteria.

Multiple portable classroom buildings are on the east portion of the site, accessed by stairs and ramps with handrails. These buildings have painted wood siding with Masonite trim, dual pane operable windows with aluminum frames, and galvanized metal roofs with gutters and downspouts. Interior spaces have suspended acoustical ceiling systems, broadloom carpet with resilient base, and painted gypsum board walls.

The permanent building's interior spaces have glue on acoustic tile, suspended acoustic tile and plaster ceilings, painted walls, wood trim, built-in casework, carpet, rubber wall base, and VCT flooring. Some classrooms are equipped with whiteboards, overhead media projectors and pull-down screens. The exterior fenestration has both operable and fixed glass windows with painted wood frames. Doors are painted solid wood with glass transoms.

Accessible women's and men's restrooms are located in the center of campus, and drinking fountains are placed along the covered walkway. The restrooms have the original ceilings, toilet partitions, ceramic floor and wall tile, with newer plumbing fixtures and lighting.

All spaces utilize an addressable fire alarm system, fire alarm pull stations, and have fire extinguishers at the exits. There are two Automated External Defibrillators (AED) stations as well as four emergency phones with blue lights on top.

## **2. Major Findings**

The exterior of the buildings have recently been repainted, and continue to be in very good condition.

The following are major findings discovered during the assessment:

- Ceiling systems - The glue on acoustic ceiling tiles are fair condition, with minor damage and staining present. The auditorium ceiling tiles have been secured in place with screws. A few spaces have been updated with suspended acoustic ceiling systems, which are in fair condition, but components such as: suspension hanger and bracing wire types and attachments, compression posts, main and cross runners, splices, expansion devices, intersection connectors, fire rating, and total system weight, likely no longer meet current ASTM ratings, the CBC, or Department of the State Architect (DSA) requirements.
- Interior lighting - Although some rooms have had lighting renovations, most spaces have older light fixtures which may no longer meet Energy (Title 24) requirements, and should be replaced.
- Restrooms - The men's and women's restrooms have been partially renovated to meet ADA requirements, but did not receive a major renovation, and the finishes and fixtures are in poor condition. The ceramic floor and wall tile, and toilet partitions are original. These spaces would benefit from a major renovation.
- Drinking Fountains - Drinking fountains are located along the exterior corridors, are antiquated and do not meet current codes. No hi-low fountains are provided, and therefore, the site does not meet the 50% ratio of hi-low accessible drinking fountains required by code, and accommodations should be provided.
- Life Safety Systems - The fire alarm was updated 1998, and appears to be in good working order. There is an AED station inside the auditorium and one in the exterior corridor. Four Emergency phones are on located throughout the site. These emergency items appear to be new, and in proper working order.
- Roofing - The built-up roofing system was repaired and partially replaced in 1998 and 2003, and appears to be in good condition.
- Parking - Both the west and east parking lot asphalt is in poor and deteriorated condition, and requires restoration.



### **3. Site Findings**

The buildings on this site are surrounded by grass, trees, landscaping and parking lots. The front west parking lot is accessed via the main driveway off North Turnpike Road, and the lower eastern lots at the rear of the property are reached by access roads at both the north and south edges of the site. Contrasting the other SBCC facility locations, the public generally accesses the Wake Center by vehicle, not predominately on foot.

The asphalt surface in all parking lots are in poor condition and the stripping is faded. The surface has raveling, alligator cracks, upheaval and depressions. Cracks have been filled with slurry, but the surfaces would benefit from a full restoration and restriping.

The proper number and type of accessible parking spaces are provided throughout the site, but there are not safe or compliant paths of travel from these spaces to the walkways or classrooms they serve.

The intended accessible path of travel walkways within the facility are accessed from the parking lots by sloped asphalt ramps, but are not marked with any way finding signage.

Within the campus, circulation around the buildings is upon both asphalt and concrete paving. The main classrooms and office entrances are protected by roof overhangs and an overhead canopy system, while the portable buildings are accessed directly from the parking lots. There are multiple locations where the concrete walkways are cracked, uneven, and require repair or replacement.

The north and east sides of the campus have an exterior staircases with cracked concrete, faded nosing stripping and non-compliant handrails. There are no wayfinding signs directing the user to an alternate accessible path. These staircases would benefit from the addition of signage, and ramps or sloped walkways.

The site is lit by pole and flood lighting, and surface mounted fixtures in the walkway overhangs. The outdoor lighting should be reevaluated for Title 24 compliancy.

## ***4. Architectural Findings***

The following architectural items were discovered during the assessment:

**ROOF:** The built-up roofing system appears to be in good condition.

**CEILINGS:** Ceilings are a variety of plaster, glue on acoustic tile, and suspended ceiling systems. The enclosed patio ceilings have exposed roof systems, not matching other interior ceiling materials. The facility would benefit from a full modernization of all ceiling systems.

**WALLS:** Interior walls in both the permanent and portable buildings are stained, damaged, and are in general need of repair and repainting. The exterior paint at both the permanent and portable buildings is in very good condition.

**FLOORING:** The exterior concrete walkways are in fair condition with cracks, uneven surfaces and deteriorated materials. The interior flooring varies throughout the facility and includes broadloom carpet, carpet tile, VCT, wood, and exposed concrete. Although the carpet tile is in good condition, all other finish materials are dated, worn, and should be replaced. During any renovation, abatement may be required in some areas with 9"x9" resilient tile flooring.

**RESTROOMS:** Though the restrooms have been made ADA compliant, and the plumbing fixtures appear to be functional, the accommodations have been made in a piecemeal fashion. The finishes, colors, fixtures and equipment are dated, and damaged from years of use, and are in need of repair and restoration. ADA restroom signage is also non-compliant and the doors utilize electric door operators, but lack the lower level push plate now required by code.

## ***5. Mechanical Findings***

The original heating systems for the Wake Center consist of gas fired forced air heating units located in small mechanical rooms within in or close to the spaces served.

Some cooling systems have been added by installing cooling coils directly onto the forced air units. In some areas, air cooled condensing units have located on the roof above. Cooling has also been added by using mini split heat pump systems.

The air distribution and some zoning is insufficient and causing comfort issues for the occupants.

Outside air intakes are present but many have been blocked off.

Forced air units, cooling coils, condensing units and controls are at the end of their useful life and should be replaced with high efficiency units with cooling coils and high efficiency condensers.

The mini-split heat pumps should be removed as they conflict with the heating systems, (heating and cooling can be performed at the same time).

Air distribution should be replaced with corrected zoning and sizes. Outside air ducts should be replaced with volume dampers installed for proper balance.

The site would benefit from a complete HVAC upgrade including air distribution and controls.

## ***6. Electrical Findings***

Upgrades to the electrical and fire alarm systems were made in 1998. Electrical service and panel upgrades were made in 1994, 1996, 1997, 2004 and 2007.

Service Disconnecting Means are present, in good working order, are in-site, but are not readily accessible as there are debris and storage items blocking the minimum clear working space in front of electric equipment. Ground Fault Protection and grounding electrodes are present and appear in good working order. Electrical panels have circuit directories, but it is unknown if the directories are up to date. Energy efficient lighting for interior and exterior are being upgraded on an on-going basis. Life-safety elements and emergency lighting are present. Adequate illumination of interior and exterior spaces appears to be present, but indoor and outdoor lighting fixtures are older, and may no longer meet current Title 24 code requirements.

## ***7. ADA Building Descriptive Report***

The building access from both parking lots lack any wayfinding signage. The lower parking lot utilizes long exterior concrete staircases with non-compliant handrails and landings to get up to the level of the classrooms.

Most permanent classroom and office entrances provide compliant thresholds, but many of the portable buildings do not. There are multiple exit and interior doors that do not provide adequate push-pull side clearances.

Classroom 32, which houses the weaving lab, was added onto the auditorium building at a later date, and provides neither an accessible entrance to the space, nor accommodations within the space at the change in floor height.

Casework within classrooms and offices provides neither clear floor spaces, nor lowered counter heights to accommodate wheelchair users.

Men's and women's student restrooms have been made ADA compliant, but lack the electric door opener lower level push plate at the now required by code.

The site does not provide the required number of hi-low drinking fountains.

The buildings do have updated compliant exterior room identification signs, nor do they have proper tactile exiting signs. Site wayfinding signage is also needed to direct users to the accessible site entrance.

## **8. Inspector's Notes**

The building has been generally well maintained, but is not fully functional for its intended uses. It is in need of a significant modernization to be brought up to the level of other college and educational buildings of this type. A modernization of entrances, floors, walls, ceilings, lighting, mechanical, plumbing, fixtures and equipment is recommended.

The surrounding site is in need of modernization to be brought up to current ADA accessibility codes.

## **9. Summary**

The Wake Center campus is well used and beloved by the community, but has not had a comprehensive modernization since the buildings were built almost 60 years ago. Some of the buildings' exterior patios have been renovated without proper construction techniques, and have pad-a-locked exits causing potential life safety hazards. The interior space next to the auditorium was the Student Services office, but is no longer used due to a lack of funding. The Kitchen cafeteria has new fixtures and in good condition, but is also under-utilized.

The interior finishes, casework, equipment, utilities, and HVAC systems in both permanent and portable buildings are outdated, deficient and worn, have reached the end of their useful life, and would benefit from a major modernization to meet the quality and life-cycle of similar educational facilities.

The surrounding exterior circulation does not provide a successive compliant path of travel from the accessible parking stalls onto the walkways. Building and site signage, handrails, ramps, walking slopes and building entrances should be renovated for proper accessibility.

The existing buildings are considered salvageable, but due to the age of the facility, the elementary school design and the potential for hazardous materials modernization, it is not a feasible or recommended solution. Instead, rebuilding a new facility in a denser, more efficient configuration is recommended.

Redeveloping the existing Wake Center facility would allow the College to take advantage of and efficiently utilize the 9-1/2 acre site, and develop it into a mixed use campus for both instructional programs and the Center for Lifelong Learning. These programs would not only provide students with new state-of-the-art facilities, it would also reduce parking demand at the main campus, address regulatory limitations on growth at the main campus, and maximize use of the District's only property that has potential for growth and expansion.

# **APPENDIX A BUILDING PLANS**

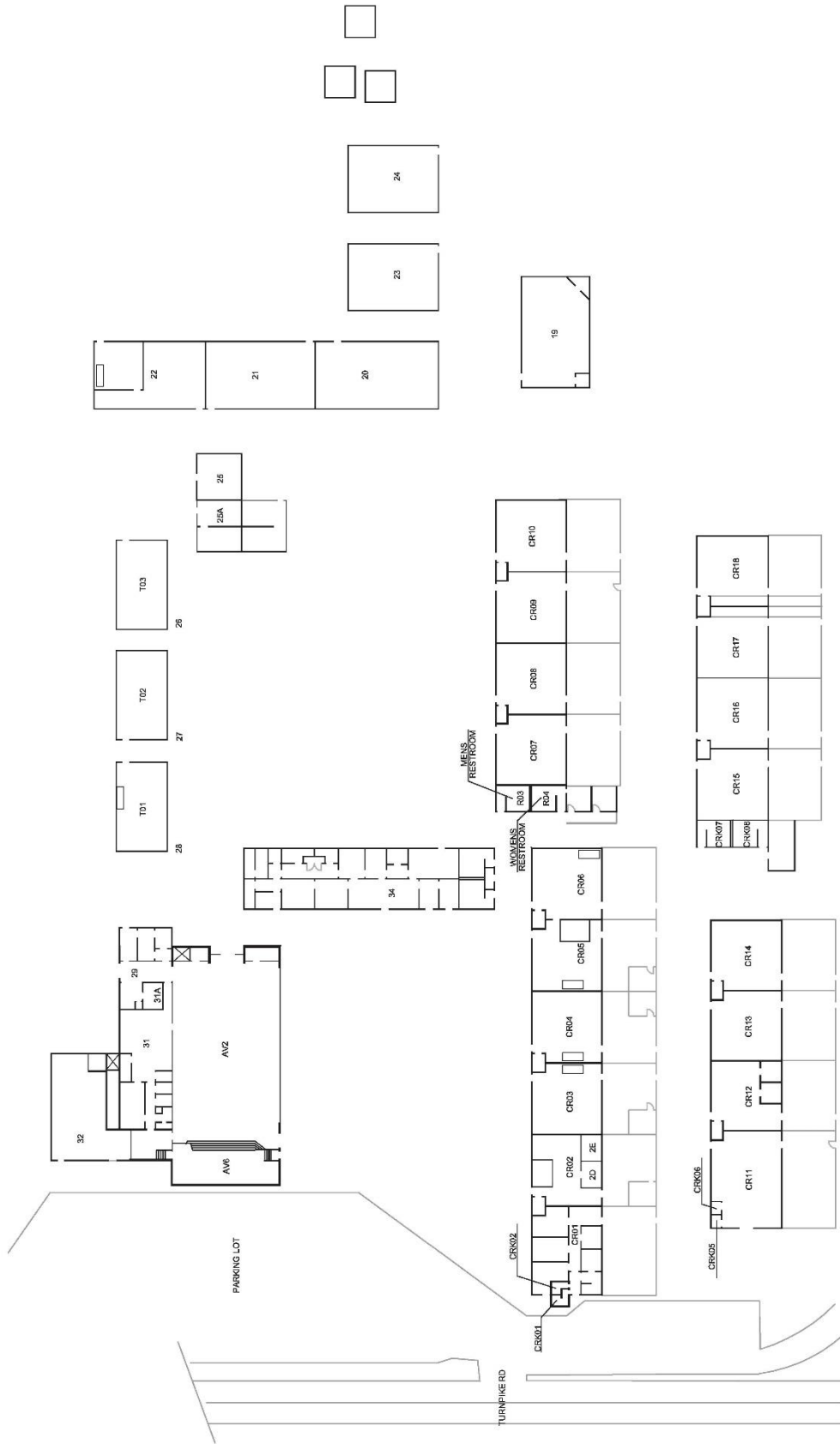

NO SCALE

WAKE CENTER SITE / FLOOR PLANS

# APPENDIX B

## PHOTO LOG & NARRATIVE

1. Architectural
  - a. Exterior
    - 1) Wall Finishes
    - 2) Roof Systems
    - 3) Entrances/Doors
    - 4) Windows
    - 5) Floor Finishes
  - b. Interior
    - 1) Wall Finishes
    - 2) Ceiling Systems
    - 3) Doors
    - 4) Floor Finishes
2. Building Systems
  - a. Mechanical
  - b. Electrical
  - c. Plumbing
3. Accessibility
  - a. Restrooms
  - b. Drinking Fountains
  - c. Stairs
  - d. Elevators - none.
  - e. Signage
  - f. Path of Travel



## EXTERIOR

- Wall finishes



AE1. Exterior patio CMU wall; damaged.



AE2. Exterior wall; painted CMU and wood, good condition.



AE3. Exterior wood patio fence; damaged paint.



AE4. Exterior painted concrete and plaster.

## EXTERIOR

- Roofs Systems



R1. Overall site; roofs.



R2. Gutter and downspout.



R3. Enclosed patio; underside of exposed roof structure.

## EXTERIOR

- Entrances/Doors



D1. Classroom 16; exterior door; fan in transom.



D2. Portable 22, excessive threshold height.



D3. Classroom patio; locked gate to exterior.



D4. Classroom patio; locked gate to exterior.

## EXTERIOR

- Windows



EW1. Exterior fixed wood windows; new paint.



EW2. Exterior fixed wood windows; new paint.

## EXTERIOR

- Floor Finishes



EF1. Exterior corridor walkway; cracked and degraded concrete.



EF2. Exterior sidewalk transition; abrupt change in level.



EF3. Exterior corridor walkway; cracked and degraded concrete.



EF4. Exterior corridor walkway; abrupt changes in level.

## INTERIOR

- Wall finishes



AI1. Auditorium; water damaged exposed CMU and wood finishes.



AI2. Office 29; painted drywall.



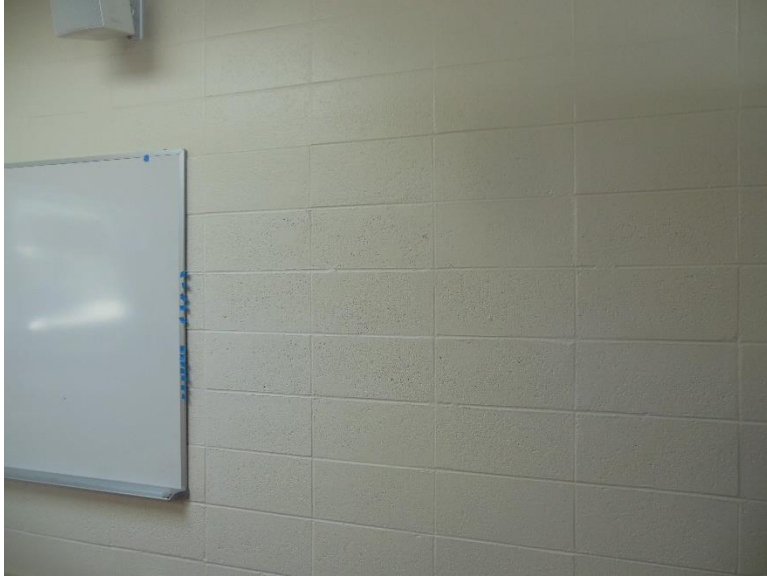

AI3. Classroom; painted interior CMU wall.



AI4. Restroom foyer, original ceramic tile wainscot.

## INTERIOR

- Ceilings Systems



C1. Classroom; glue on ceiling tiles, typical.



C2. Auditorium; glue on ceiling tiles, screwed into sub-structure.



C3. Office 2; glue on ceiling tiles with surface mounted lights.



C4. Classroom 32; suspended ceiling system, with recessed lights, typical.

## INTERIOR

- Doors



D1. Office 2; interior door.



D2. Classroom 32; interior roll-up door.

## INTERIOR

- Floor Finishes



IF1. Auditorium; VCT.



IF2. Office 02; 4; broadloom carpet and rubber base.



IF3. Classroom; VCT.

## BUILDING SYSTEMS

- Mechanical



M1. Gas fired forced air heating units in mechanical closet, typical.



M2. Gas fired forced air heating units; clear floor space not provided.

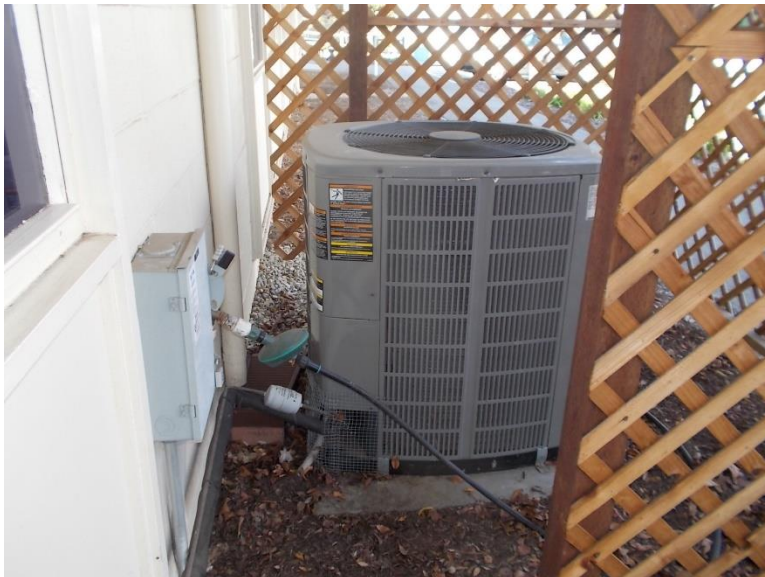

M3. Outside Administration Offices; mini split heat pump system.



M4. Mechanical space under Kitchen; exposed insulation.



M5. Hot water heater, clear floor space not provided.

## BUILDING SYSTEMS

- Electrical

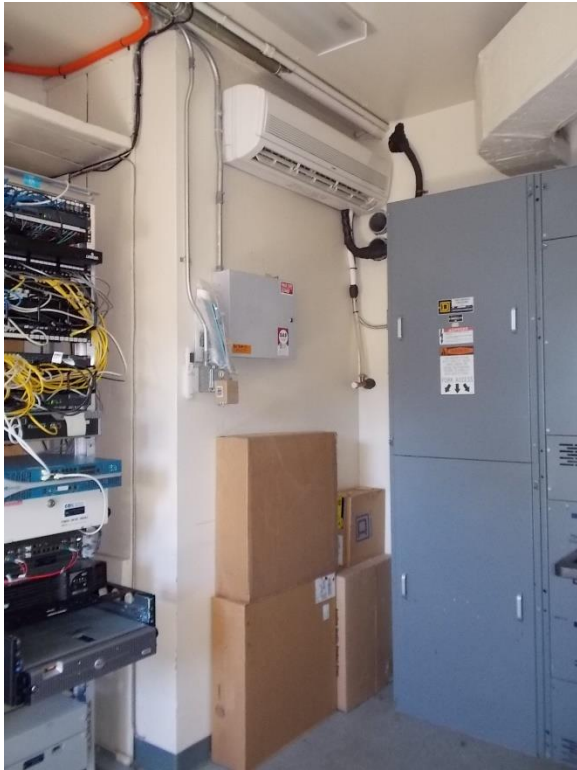

E1. Electrical transformer; with AC unit.



E2. Classroom; exposed conduit and wall mounted duplex outlet.



E3. Glass fusing classroom; power supply hanging from above.



## ACCESSIBILITY

- Restrooms



RR1. Women's Restroom; laboratories.



RR2. Women's Restroom; accessible stall, missing back handrail and stall size too small.



RR3. Men's Restroom; lavatories and urinals.



RR4. Men's Restroom; missing back handrail; and stall size too small.



RR5. Mens foyer; door clearances not provided.

## ACCESSIBILITY

- Drinking Fountains



DF1. Drinking fountain in exterior walkway; hi-low fountains are not provided.



DF2. Drinking fountain in exterior walkway; hi-low fountains are not provided.

## ACCESSIBILITY

- Stairs

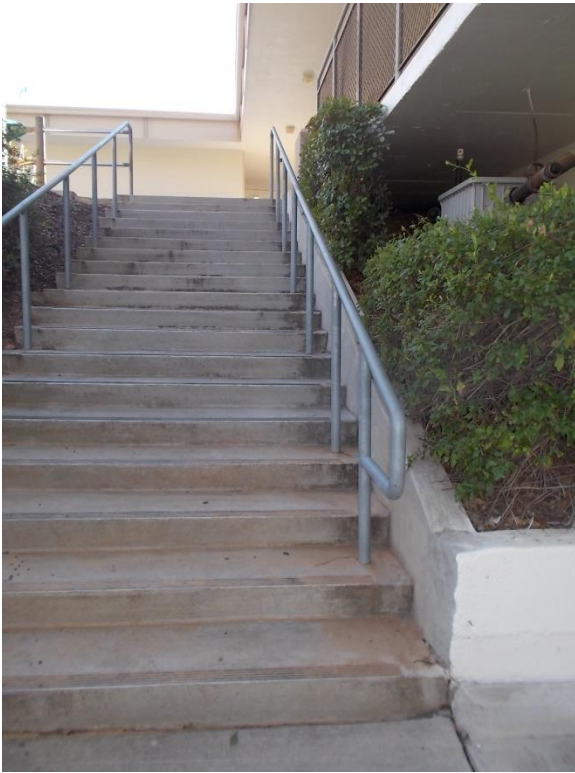

ST1. Exterior stairs to Auditorium; non-compliant handrails, and signage missing.

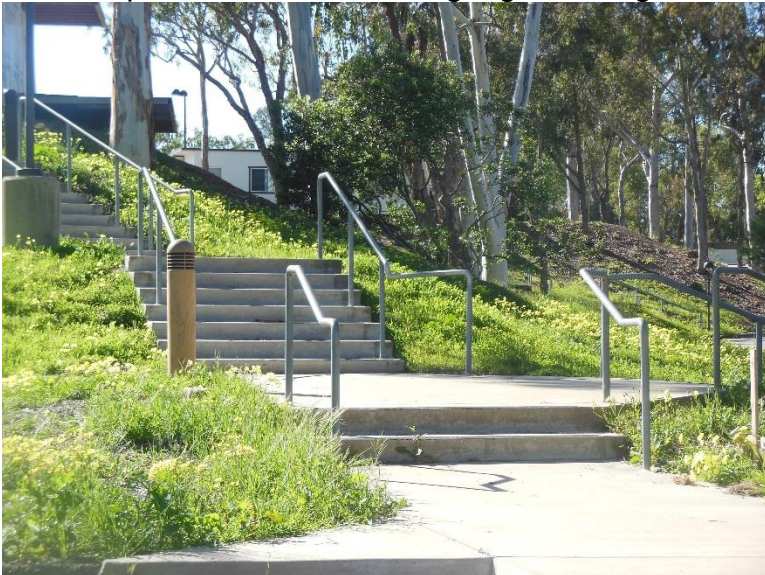

ST2. Exterior stairs from lower lot to upper campus; non-compliant handrails, stair nosing and signage missing.

## **ACCESSIBILITY**

- Elevators

None on site.

## ACCESSIBILITY

- Signage



S1. Exterior room identification and wayfinding signs; non-compliant.



S2. Restroom room identification signs; non-compliant mounting locations.

## ACCESSIBILITY

- Path of Travel



PT1. Room 32; door threshold exceeds 1/2" maximum.



PT2. Exterior walkway; uneven, excessive slopes at path of travel.

# **APPENDIX C EXISTING BUILDING DETAILS**



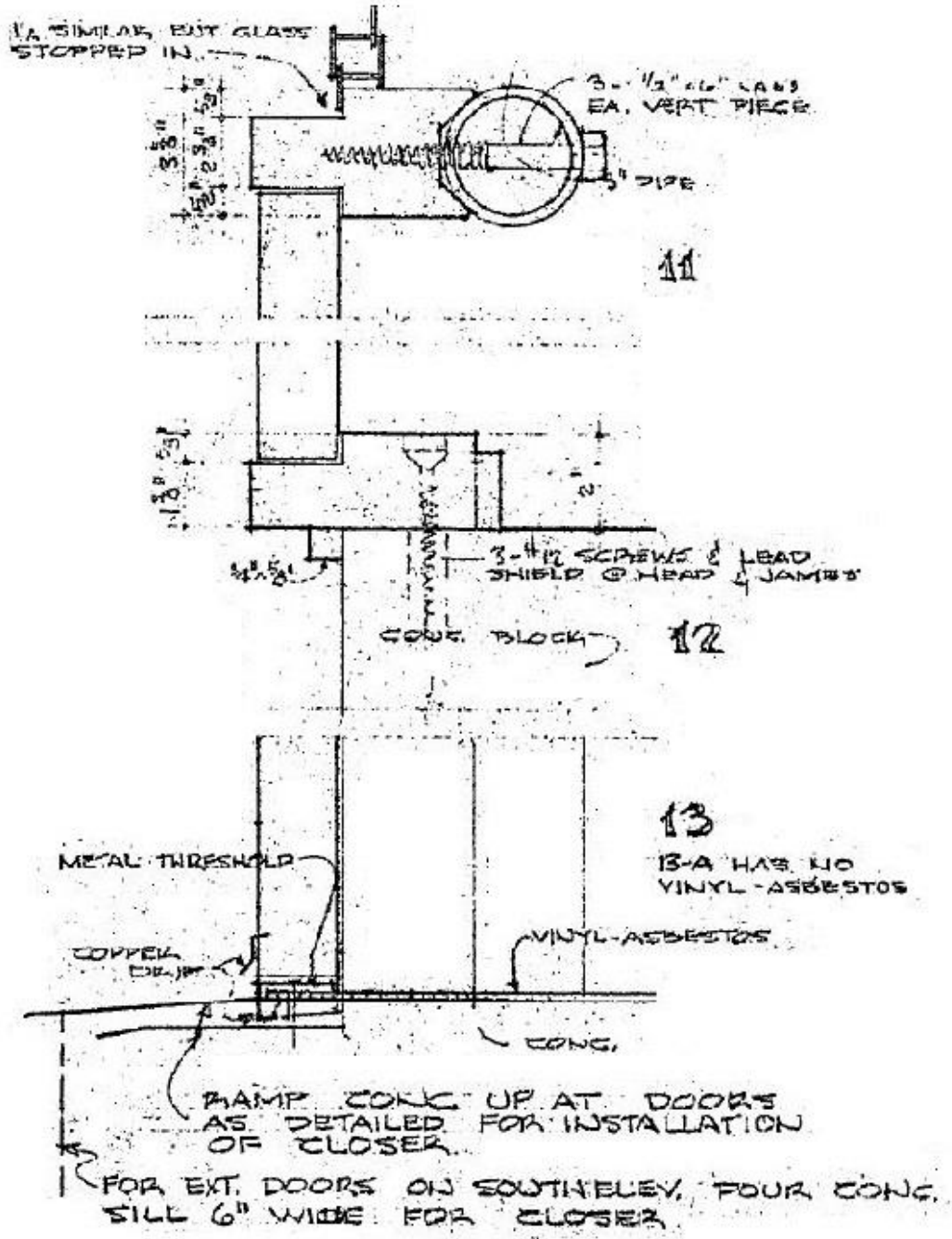



# Facility Condition Assessment Report SCHOTT CENTER

*Prepared for*



**SANTA BARBARA CITY COLLEGE**

**Schott Center  
310 West Padre Street  
Santa Barbara, CA 93105**

RJC Project No: 2015.46



*Prepared by*  
**RJC Inc.**

**Facility Condition Assessment Report**  
**Santa Barbara City College**  
**Schott Center**  
**310 West Padre Street**  
**Santa Barbara, CA 93105**

March 04, 2016

---

---

*TABLE OF CONTENTS*

*Description*

<i><u>Number</u></i>	<i><u>Page</u></i>
1. Facility Description	2
2. Major Findings	3
3. Site Findings	4
4. Architectural Findings	5
5. Mechanical Findings	6
6. Electrical Findings	6
7. ADA Building Descriptive Report	7
8. Inspectors Notes	8
9. Summary	8

*Appendix*

A. Building Plans	9
a. First Floor	10
B. Photo Log and Narrative	11-42
C. Existing Building Details	43-46

# **1. Facility Description**

Year Built: 1934

Floor Area: 27,271 sf

Construction type: Mixed occupancy, B-2 (offices and education), A-3 (assembly)

The Schott Center was originally built in 1934, as the Garfield Elementary School, and currently includes 20,072 square feet of permanent buildings, 4,320 square feet of portable classrooms, and 2,879 square feet of ceramic facility and storage buildings. It occupies approximately three-quarters of a standard city block. It is surrounded by both paved and landscaped areas, offering several locations to enter the site using sloped walks and stairs.

The facility is located in a central downtown mixed-use area, with residential, religious, office and medical buildings located nearby. The facility is used by the “Adult Education” program, offered through Santa Barbara City College under the name of the Center for Lifelong Learning, serving both young and older students. Classes are in session during both the day and night, all year round, following the same school calendar as SBCC.

The existing permanent buildings are one story with some utilized attic space, built with wood frame construction, slab on grade and concrete post footings. The exterior building finish is painted plaster, and the clay tile roof system has copper gutters and downspouts. An exterior concrete walkway is covered by a canopy system with painted exposed wood trusses and decorative corbel brackets. This exterior walkway follows the building layout, with office and classroom doors opening directly into it.

Four portable classroom buildings are on the north portion of the site, accessed by stairs and ramps with handrails. These buildings have painted wood siding with Masonite trim, dual pane operable windows with aluminum frames, and galvanized metal roofs with gutters and downspouts. Interior spaces have suspended acoustical ceiling systems, broadloom carpet with resilient base, and painted gypsum board walls.

The permanent building’s interior spaces have suspended acoustic tile and plaster ceilings, painted plaster walls, wood trim, built-in casework, carpet, rubber wall base, and VCT flooring. Some classrooms are equipped with whiteboards, overhead media projectors and pull-down screens. The exterior fenestration has both operable and fixed glass windows with painted wood frames. Entry doors are painted solid wood with vision panels and glass transoms, and interior doors are painted wood.

Instructional spaces are situated around the perimeter of the facility, with administration offices and an auditorium space centrally located. Accessible women’s and men’s restrooms are located on the west side of campus, and drinking fountains are placed along the covered walkway. The restrooms have the original ceilings, toilet partitions, ceramic floor and wall tile, with newer plumbing fixtures and lighting.

All spaces utilize an addressable fire alarm system, fire alarm pull stations, and have fire extinguishers at the exits. There are two Automated External Defibrillators (AED) stations as well as two emergency phones with blue lights on top.

## **2. Major Findings**

In 2014 all windows and doors in the permanent buildings were abated, repaired, and repainted, and continue to be in excellent condition.

The following are major findings discovered during the assessment:

- Ceiling systems - Most of the suspended ceiling systems in the classrooms are in good condition, with some minor damage and staining present. The plaster ceilings in the offices and the suspended ceilings in the portable building classrooms are stained, damaged, and have miss-matched colors and finishes. Components such as: suspension hanger and bracing wire types and attachments, compression posts, main and cross runners, splices, expansion devices, intersection connectors, fire rating, and total system weight, likely no longer meet current ASTM ratings, the CBC, or Department of the State Architect (DSA) requirements.
- Interior lighting - Although some classrooms have had lighting renovations, other spaces have older light fixtures which may no longer meet Energy (Title 24) requirements and should be replaced.
- Restrooms - The men's and women's restrooms were partially renovated in 2008 to meet ADA requirements, but did not receive a major renovation, and the finishes and fixtures are in poor condition. The ceramic floor and wall tile, and marble toilet partitions are original. These spaces would benefit from a major renovation.
- Drinking Fountains - Three single drinking fountains with guardrails are located in the exterior corridor, but no hi-low fountains are provided. Therefore, the site does not meet the 50% ratio of hi-low accessible drinking fountains required by code, and accommodations should be provided.
- Life Safety Systems - The fire alarm was updated 2004, and appears to be in good working order. There is an AED station inside the auditorium and one in the exterior corridor outside Room 17. Emergency phones are located next to Room 16, and at the main vehicular entrance at the east side of the campus. These emergency items appear to be new, and in proper working order.
- Roofing - The clay tile roofing system was replaced in 1998 and appears to be in good condition.
- Parking - Both the center and west parking lot asphalt is in very poor and deteriorated condition and requires restoration.
- Auditorium - The drapery lining is badly torn and requires replacement.

### **3. Site Findings**

The permanent buildings are configured in a “C” shape layout, oriented on the site with large windows facing the street, surrounded by grass, trees, and landscaping.

The site is slightly higher than the adjacent public street, creating both sloping and staircase entry points. The three main entrances from the public right of way are on the west, east and south sides of the site. A central interior parking lot is accessed via the east side of the site, and a smaller exterior lot from the west. Parking on the site is somewhat limited, and students occasionally utilize neighborhood street parking. Bicycle and scooter parking is provided near the vehicular driveway, which is also adjacent the public bus stop.

Although the public sidewalks surrounding three sides of the facility are beyond the property line, these sidewalks provide access to all entry points onto the campus, as well as to the public bus stop. These public walks have excessive cross and longitudinal slopes, abrupt changes in level, hazardous surface features, and non-compliant curb ramps.

The intended accessible path of travel into the facility is on the east side, but is not marked with an International Symbol of Accessibility (ISA) sign.

The south and west sidewalks lead up to staircase entries with cracked concrete, faded nosing stripping and non-compliant handrails. There are no wayfinding signs directing the user to the accessible east entrance. These staircases would benefit from the addition of signage, and a ramp or sloped walkway.

Once on the campus property, circulation around the buildings is upon both asphalt and concrete paving. The main classroom and office entrances are protected by an overhead canopy system. There are multiple locations where the concrete walkway is cracked and requires repair or replacement.

The asphalt surface at both parking lots is in very poor condition, and the stripping is faded. The asphalt surface has raveling, alligator cracks, upheaval, and depressions. Cracks have been filled with slurry, but the surfaces would benefit from a full restoration and restriping. Additionally, the main lot slopes toward a poor draining catch basin in the southwest corner by Rooms 17 and 20. During periods of heavy rain, this area floods up to the doors, due to excessive storm water retention.

The proper number and type of accessible parking spaces are provided, but there is not a safe, nor compliant, path of travel from these spaces to the walkways. Curb ramps protrude into the vehicular space, have non-compliant slopes, and do not have truncated domes.

## ***4. Architectural Findings***

The following architectural items were discovered during the assessment:

**ROOF:** The clay tile roofing system was replaced in 1998 and appears to be in good condition.

**CEILING:** Ceilings are original plaster and suspended acoustical ceiling systems. Plaster ceilings require repainting, and those suspended ceiling not recently renovated required replacement.

**WALLS:** Interior walls at both the permanent and portable buildings are stained, damaged, and in general need of repair and refinishing. The exterior plaster paint is in fair condition, but at locations where partial repainting was performed due to damage and/or vandalism, the hue of the repainted surfaces doesn't match the adjacent surface color. Overall exterior wall painting should be performed.

**FLOORING:** The exterior concrete walkways are in poor condition with deep cracks and uneven surfaces and deteriorated materials. The interior flooring varies throughout the facility and includes broadloom carpet, carpet tile, VCT, wood, and exposed concrete. Although the carpet tile is in good condition, all other finish materials are dated and worn, and should be replaced. During any renovation, abatement may be required in some areas with 9"x9" resilient tile flooring.

**RESTROOMS:** Though the student restrooms have been made ADA compliant, and the plumbing fixtures appear to be functional, the accommodations have been made in a piecemeal fashion. The finishes, colors, fixtures and equipment are dated and damaged from years of use, and are in need of repair and restoration. ADA restroom signage is also non-compliant. There are small staff restrooms adjacent Offices 9 and 13, and Classroom 27 that have not been modernized and remain non-compliant. Exit doors utilize electric door operators, but lack the lower level push plate now required by code.



## ***5. Mechanical Findings***

The original heating systems for the Schott Center consist of gas fired forced air heating units located in small mechanical rooms within the space they are serving.

Some cooling has been added using mini split heat pump systems.

The air distribution and some zoning is insufficient and causing comfort issues for the occupants.

Outside air intakes are present but many have been blocked off.

The forced air units are at the end of their useful life and should be replaced with high efficiency units with cooling coils and high efficiency condensers.

The mini-split heat pumps should be removed as they conflict with the heating systems (heating and cooling can be performed at the same time).

Air distribution should be replaced with corrected zoning and sizes. Outside air ducts should be replaced with volume dampers installed for proper balance.

The site would benefit from a complete HVAC upgrade including air distribution and controls.

## ***6. Electrical Findings***

Inside Room 13, there is a distribution panel, electrical panel, a transformer, and the main utility service meter. This equipment is located immediately adjacent an office working space, and produces copious amounts of noise. Southern California Edison personnel must enter this office and relocate furniture in order to read the meter.

The following electrical renovations have been performed at this facility: electrical service revisions, Computer Lab 16 power and data renovations in 2001, panel upgrades in 2004, and parking lot light replacement in 2010.

The portable buildings have old, antiquated surface mounted duplex receptacles and conduit.

Service Disconnecting Means are present, in good working order, are in-site and but are not readily accessible as there are debris and storage items blocking the minimum clear working space in front of electric equipment. Ground Fault Protection and grounding electrodes are present and appear in good working order. Electrical panels have circuit directories, but it is unknown if the directories are up to date. Energy efficient lighting for interior and exterior are being upgraded on an on-going basis. Life-safety elements and emergency lighting are present. Adequate illumination of interior and exterior spaces appears to be present, but indoor and outdoor lighting fixtures are older and may no longer meet current Title 24 code requirements.

## ***7. ADA Building Descriptive Report***

The three site entries are through arched openings with decorative metal gates. The east entry is intended to be the wheelchair accessible entrance, but lacks any ISA symbol signage. The west and south entries are upon stairs with non-compliant handrails.

On the south side of the site, most of the existing exterior office door thresholds were originally constructed with more than a 1/2" height differential, making them non accessible for current ADA standards. Sloped concrete approaches have since been constructed at many of these doors, providing compliant side approach access. Although these rooms are now accessible, these ramps protrude out, and reduce the width of the walkway path of travel to less than is allowed by code.

There are multiple exit and interior doors that do not provide adequate push-pull side clearances.

An interior sloping ramp provides access into Offices 13A through 13D, but the top and bottom landings, ramp width and slope do not meet ADA requirements.

The exterior entry ramps and side exit stairs to portable building Classrooms 28A, 29, 30 and 31, have non-compliant handrails and slopes.

Casework within classrooms and offices do not provide clear floor spaces, nor do they provide lowered counter heights to accommodate wheelchair users.

The site does not provide the required number of hi-low drinking fountains.

Although the buildings do have updated compliant exterior room identification signs, some rooms lack proper tactile exiting signs. Site wayfinding signage is also needed to direct users to the accessible site entrance.

Men's and women's student restrooms have been made ADA compliant, but the small staff restrooms adjacent Offices 9 and 13, and Classroom 27 have not been modernized and remain non-compliant.

## **8. Inspector's Notes**

The buildings has been fairly well maintained, but are not fully functional for its intended uses. They are in need of a modernization to be brought up to the level of other college and educational buildings of this type. This building is historic, yet salvageable, and is recommended for modernization versus replacement. A modernization of entrances, floors, walls, ceilings, lighting, mechanical, plumbing, fixtures, and equipment is recommended.

The surrounding site is in need of modernization to be brought up to current ADA accessibility codes.

## **9. Summary**

The Schott Center campus has historical significance and is beloved by the community, but has not had a comprehensive modernization since the buildings were built over 80 years ago. The interior building finishes, casework, equipment, utilities, and HVAC systems are outdated, deficient and worn, have reached the end of their useful life, and would benefit from a significant modernization to meet the quality and life-cycle of similar educational facilities.

The surrounding exterior circulation does not provide a successive compliant path of travel onto the campus from the public right of way, public transportation, or the accessible parking stalls.

Signage, handrails, ramps, walking slopes and building entrances should be renovated for proper accessibility.

# **APPENDIX A BUILDING PLANS**

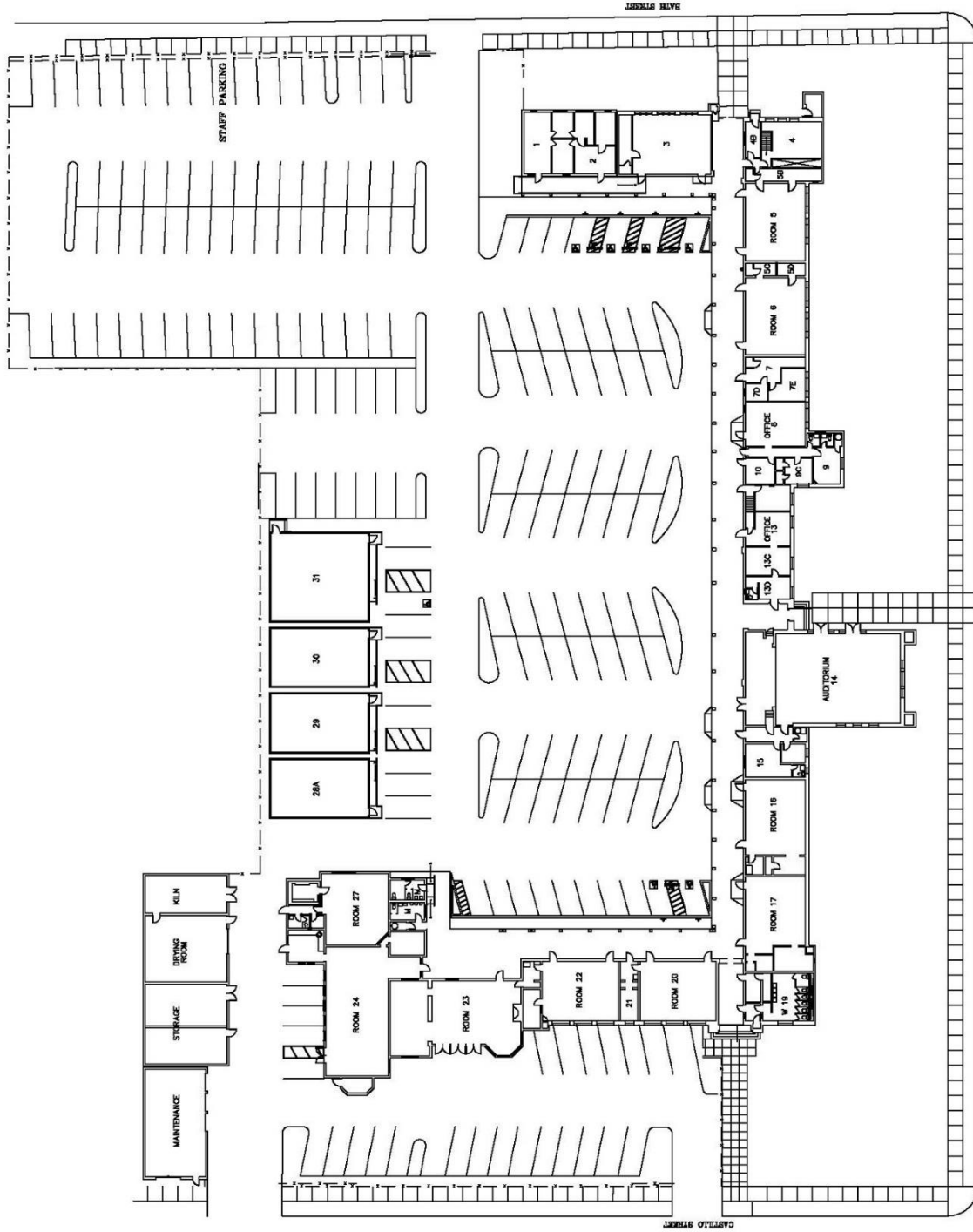

NO SCALE

SCHOTT CENTER SITE / FLOOR PLANS

# APPENDIX B

## PHOTO LOG and NARRATIVE

1. Architectural
  - a. Exterior
    - 1) Wall Finishes
    - 2) Roof Systems
    - 3) Entrances/Doors
    - 4) Windows
    - 5) Floor Finishes
  - b. Interior
    - 1) Wall Finishes
    - 2) Ceiling Systems
    - 3) Doors
    - 4) Floor Finishes
2. Building Systems
  - a. Mechanical
  - b. Electrical
  - c. Plumbing
3. Accessibility
  - a. Restrooms
  - b. Drinking Fountains
  - c. Stairs
  - d. Elevators
  - e. Signage
  - f. Path of Travel

## EXTERIOR

- Wall finishes



AE1. Permanent building exterior arch; peeling painted plaster.



AE2. Permanent building exterior wall; painted plaster, non-matching colors.



AE3. Permanent building exterior corridor wall; painted plaster damaged.



AE4. Portable building, exterior painted siding, damaged.



## EXTERIOR

- Roof Systems



R1. Portable Classroom 28A; underside of roof overhang, rusted.



R2. Permanent buildings, copper gutters, downspouts and supports in good condition.





R3. Kitchen; clay tile and roof chimney/vent, and built-up roofing over walkway canopy.



R4. Asphalt roofing over Offices 1, 2 and 3 in good condition.

## EXTERIOR

- Entrances/Doors



D1. Entrance from west side of site; missing handrails on right.



D2. Entrance from east side of site; missing ISA signage.



D3. Entrance from south side of site; non-compliant handrail returns.



D4. Auditorium backstage door; pull-side clearances not met, stairs not accessible.



D5. Office 13D door; pull-side clearances not met.



D6. Classroom 4, non-compliant threshold.

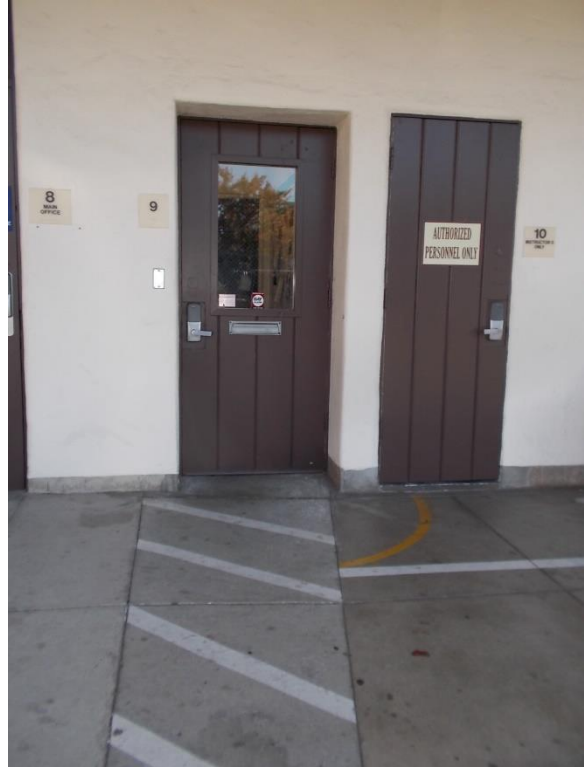

D7. Office 9 and Storeroom 10, non-compliant thresholds.

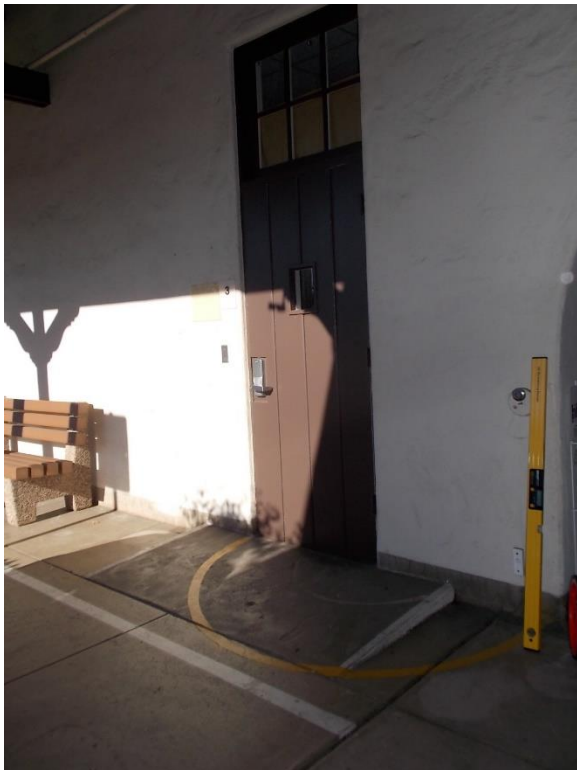

D8. Classroom 3; no level landing at entry.



D9. Classroom 23; non-compliant thresholds and no level landing at exit.

## EXTERIOR

- Windows



EW1. Exterior fixed wood windows; with new painted frames in excellent condition.



EW2. Women's restroom operable wood window with bars, and newly painted frame.



EW3. Exterior aluminum windows; frames don't match other existing windows.



EW4. Exterior fixed wood windows; with newly painted frame in excellent condition.

## EXTERIOR

- Floor Finishes



EF1. Exterior corridor walkway; cracked and degraded concrete.



EF2. Exterior sidewalk, west side; cracked and degraded concrete.



EF3. Asphalt parking lot; degraded materials, poor condition.



EF4. Drainage catch basin on parking lot with degraded surrounding asphalt materials.



## INTERIOR

- Wall finishes



AI1. Women's Restroom, ceramic wall tile damaged.



AI2. Office; hole in wall.



AI3. Office 11 foyer, plaster wall damage.



AI4. Classroom 22; fabric covered tackboard, paint damaged.

## INTERIOR

- Ceilings Systems



C1. Office; suspended acoustical ceiling system.



C2. Classroom; suspended ceiling system in good condition.



C3. Copy Room 10; glued on ceiling tile, damaged.



C4. Portable Classroom 29; damaged and miss-matched suspended ceiling tiles.

## INTERIOR

- Entrances/Doors



D1. Office 13; push-side clearance not provided, ramp is non-compliant, and adjacent door has non-compliant hardware and opens into the ramp.



D2. Classroom 22; interior painted wood door, push-side clearance not provided.



D3. Office 15; interior painted wood door, ADA room ID signage not provided.



D4. Office 11; interior painted wood door; pull-side clearance not provided.

## INTERIOR

- Floor Finishes



IF1. Main Office Room 8, damaged VCT at door.



IF2. Copy room 10; carpet tile in good condition.



IF3. Office 11 foyer, VCT floor damage.



IF4. Classroom 22; concrete topping material damage.



## BUILDING SYSTEMS

- Mechanical



M1. Outside Room 1; mini-split heat pump system.



M2. Office 12; wall mounted AC unit.



M3. Gas fired forced air heating units in mechanical closet adjacent space served, typical.

## BUILDING SYSTEMS

- Electrical



E1. Men's Restroom/Kitchen 27 exterior; electrical transformer, electrical panel and disconnect.



E2. Office 13 interior; main distribution panel, service meter, distribution panel and transformer, behind screen.

## ACCESSIBILITY

- Restrooms



RR1. Women's Restroom; lavatories and fixtures.



RR3. Women's Restroom; toilet compartments.



RR3. Men's Restroom; lavatories and fixtures.



RR4. Men's Restroom; toilet paper dispenser located too high above toilet, and protrudes into clear space above grab bar.

## ACCESSIBILITY

- Drinking Fountains



DF1. Drinking fountain in exterior walkway; hi-low fountains not provided.



DF2. Drinking fountain in exterior walkway; Handrails not provided.



DF3. Drinking fountain in exterior walkway; hi-low fountains not provided

## ACCESSIBILITY

- Stairs

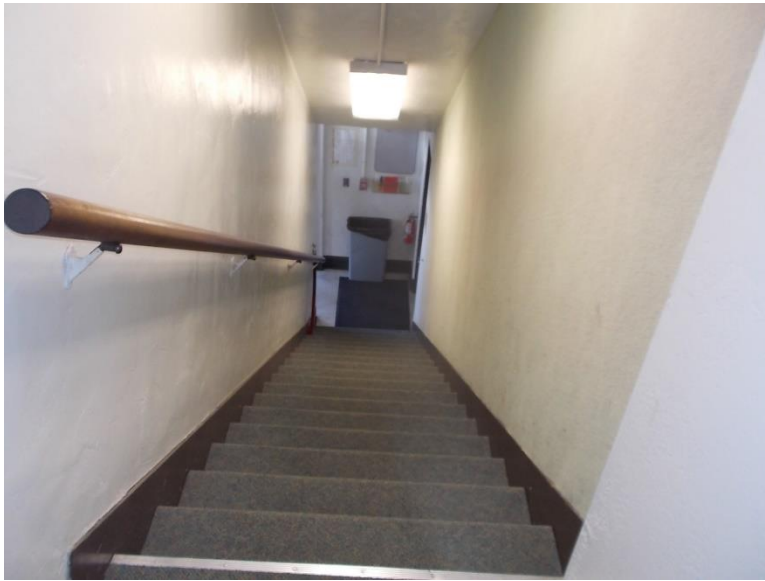

ST1. Interior stairs to Room 12; non-compliant stairwell width and handrails, and signage missing.



ST2. Stairs at west entrance; non-compliant handrails, stair nosing faded, and degraded concrete materials.

## **ACCESSIBILITY**

- Elevators

None on site.

## ACCESSIBILITY

- Signage



S1. Classroom 5; typical room ID wall signage.



S2. Women's Restroom entrance; room ID signage mounted on wrong side of door



## ACCESSIBILITY

- Path of Travel



PT1. Exterior walkway to south entry; path of travel with excessive slopes, hazardous surface features, and no wayfinding signage.



PT2. Exterior walkway; path of travel interrupted by ramp.



PT3. Curb ramp to parking lot; ramp cannot project into the path of cars, and are missing truncated domes. Concrete surface is cracked and degraded.



PT4. Curb ramps to parking lot; ramp cannot project into the path of cars, and are missing truncated domes. Asphalt surface is degraded.



PT5. Ramped walk to Men's restroom; non-compliant handrails.



PT6. Landing at ramped walk to Men's restroom; abrupt change in level.



PT7. Exterior walkway; path of travel interrupted door swing, and curb edge not provided.



PT8. Exterior walkway; path of travel with hazardous surface feature and no level landing at bottom of ramp.



PT9. Accessible stall stripping degraded, layout not-compliant and no safe path from stalls to covered walkway.



PT10. Public sidewalk at east side of site, near bus stop; abrupt changes in level, and excessive cross slope.

# **APPENDIX C**

## **EXISTING BUILDING DETAILS**

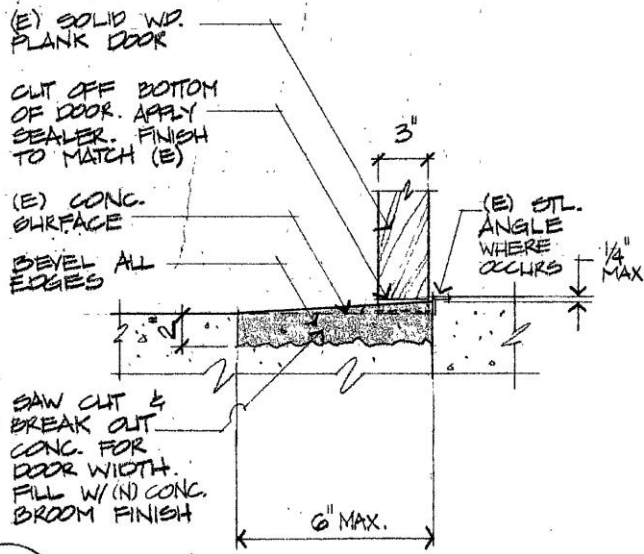

**5** DOOR THRESHOLD 1/2"=1'-0"

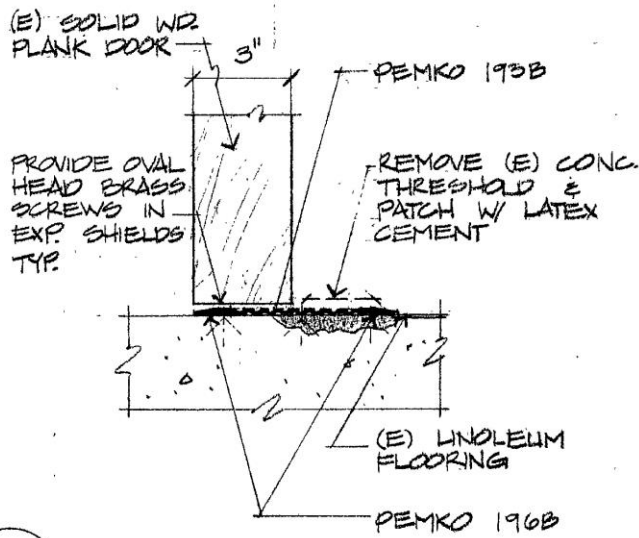

**6** DOOR THRESHOLD 3"=1'-0"

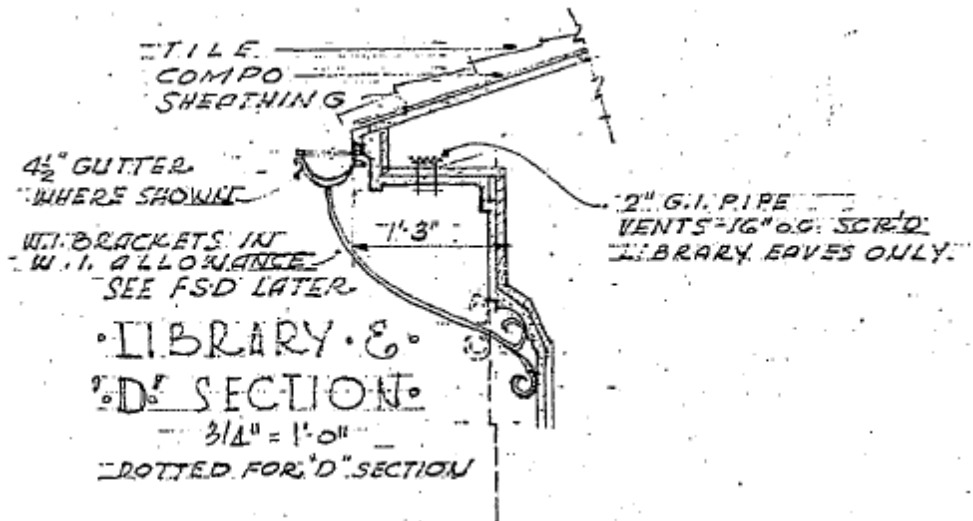
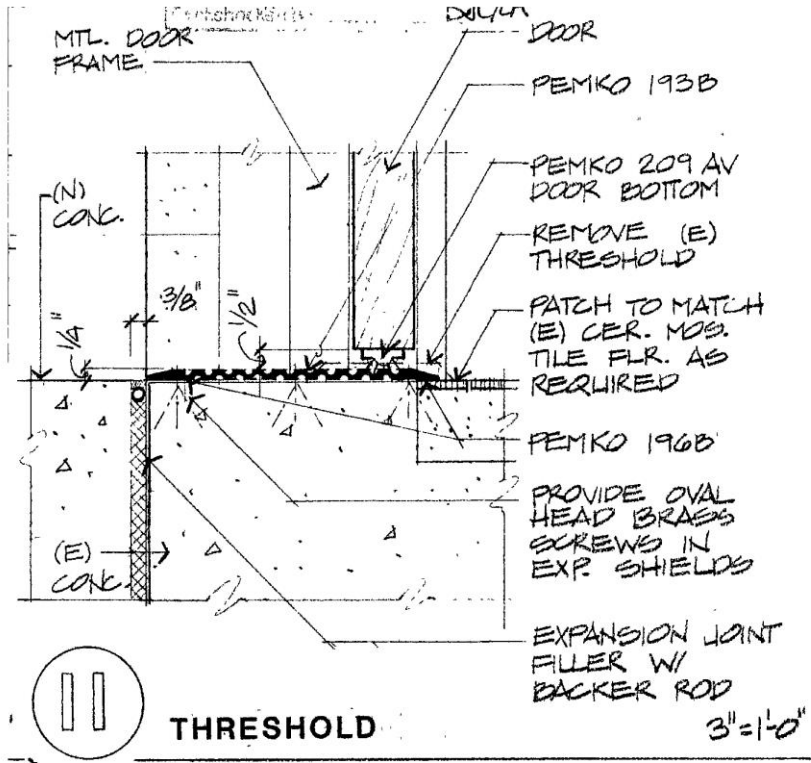



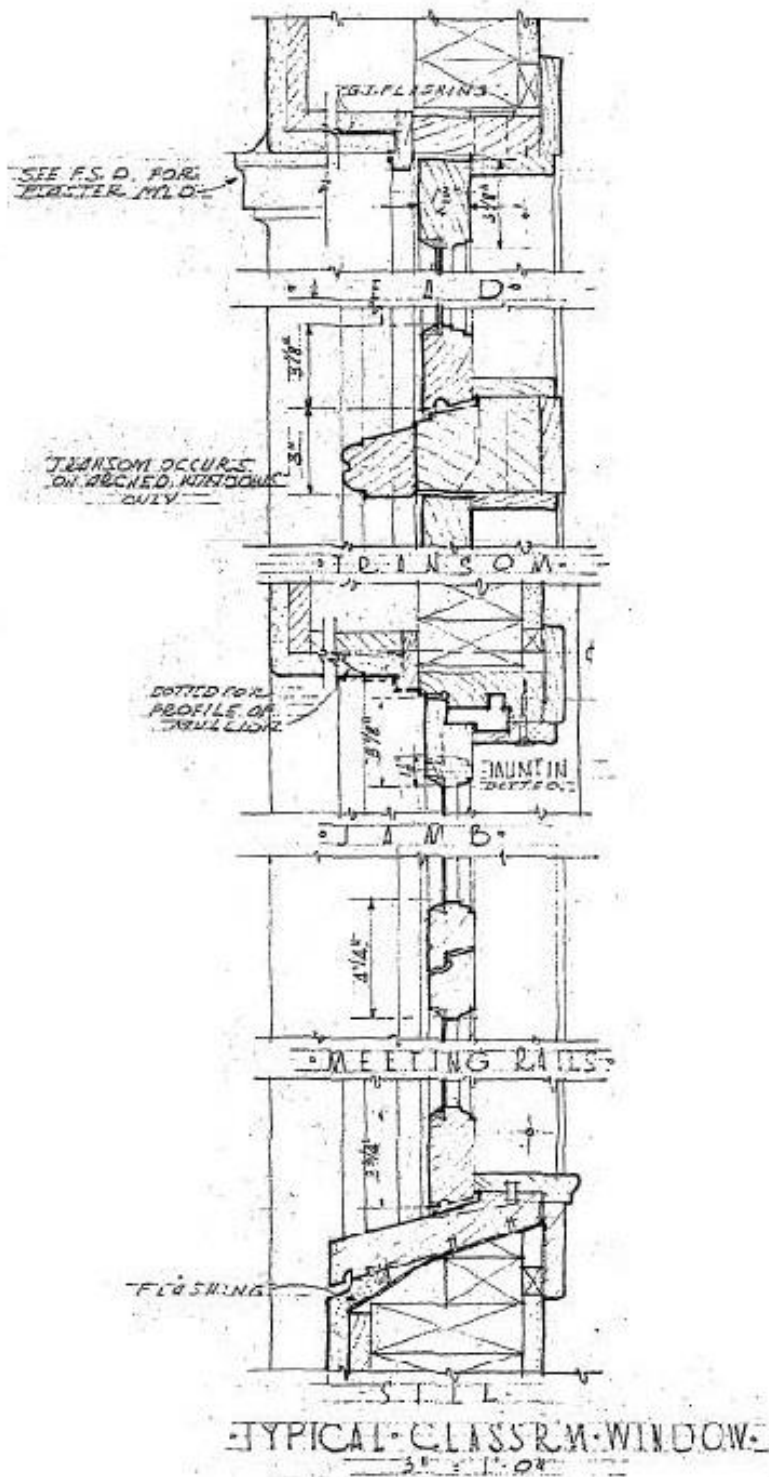

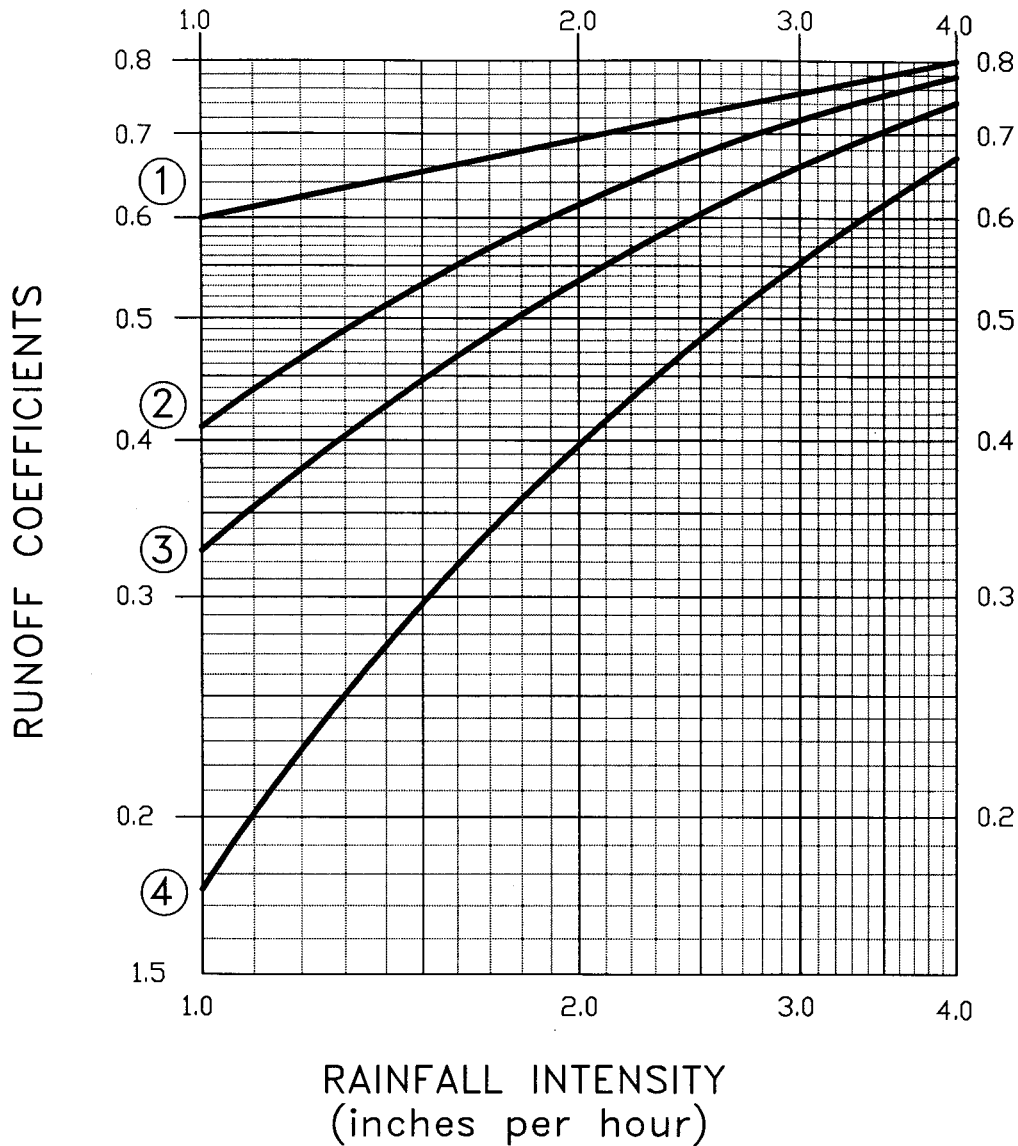

LEGEND	
①	COMMERCIAL
②	SOUTH COAST SINGLE FAMILY*
③	NORTH COUNTY SINGLE FAMILY,* SOUTH COAST AGRICULTURE
④	NORTH COUNTY AGRICULTURE

\* Single family lots with an average of 10,000 sq. ft. or more, interpolate between Single Family and Agriculture.

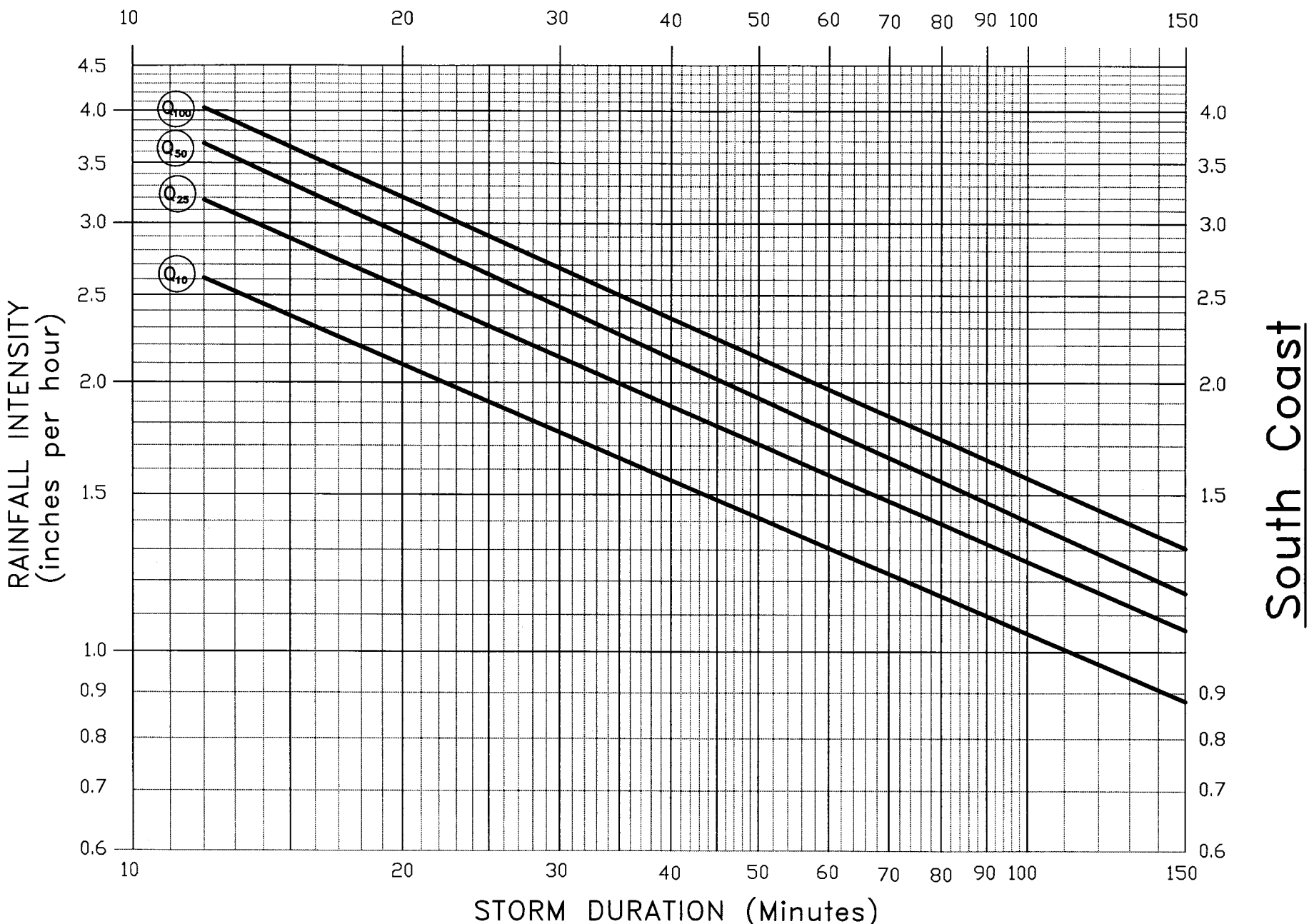

South Coast

SANTA BARBARA COUNTY FLOOD CONTROL AND WATER CONSERVATION DISTRICT

Approved by:

Feb. 25, 2004

*RAINFALL INTENSITY-DURATION CURVES*

SHEET 5 OF 6

*John D. Fin* 3/2/04  
FLOOD CONTROL DISTRICT / DATE

# Hydrology Demands

Project Name: Santa Barbara City College

## Main Campus

Tributary Area	Area (acres)	Length (feet)	ΔH (feet)	slope	T <sub>L</sub> (min)	V	T <sub>T</sub> (min)	T <sub>C</sub> (min)	C <sub>25</sub>	C <sub>100</sub>	I <sub>25,peak</sub>	I <sub>100,peak</sub>	Q <sub>25,peak</sub>	Q <sub>100,peak</sub>
Drainage Area A	1.86	299	25	0.0819	10.00	5.82	0.86	11.00	0.76	0.80	3.18	4.03	5	6
Drainage Area B	2.06	1485	86	0.0579	10.00	4.89	5.06	15.00	0.75	0.79	2.89	3.65	5	6
Drainage Area C	11.30	1275	84	0.0659	10.00	4.14	5.13	15.00	0.75	0.79	2.89	3.65	25	33
Drainage Area D	5.09	822	25	0.0304	10.00	3.55	3.86	14.00	0.75	0.79	2.97	3.76	11	15
Drainage Area E	13.44	1058	65	0.0614	10.00	5.04	3.50	13.00	0.76	0.80	3.07	3.89	31	42
Drainage Area F	2.57	805	59	0.0733	10.00	4.37	3.07	13.00	0.76	0.80	3.07	3.89	6	8
Drainage Area G	3.32	635	55	0.0866	10.00	5.98	1.77	12.00	0.76	0.80	3.18	4.03	8	11
Drainage Area H	3.42	1583	77	0.0486	10.00	4.48	5.88	16.00	0.75	0.78	2.81	3.54	7	9
Drainage Area I	13.99	706	64	0.0907	10.00	6.12	1.92	12.00	0.76	0.80	3.18	4.03	34	45
Drainage Area J	2.41	643	12	0.0187	10.00	2.78	3.86	14.00	0.75	0.79	2.97	3.76	5	7
Drainage Area K	2.76	1233	71	0.0576	10.00	4.88	4.21	14.00	0.75	0.79	2.97	3.76	6	8
Drainage Area L	20.33	2212	39	0.0176	10.00	2.14	17.21	27.00	0.71	0.75	2.23	2.81	32	43
Drainage Area M	6.44	730	92	0.1260	10.00	5.73	2.12	12.00	0.76	0.80	3.18	4.03	16	21
Drainage Area N	2.46	288	61	0.2118	10.00	7.43	0.65	11.00	0.76	0.80	3.18	4.03	6	8
Drainage Area O	2.87	884	65	0.0735	10.00	5.51	2.67	13.00	0.76	0.80	3.07	6.89	7	16
<b>Totals</b>	<b>94.32</b>												<b>203</b>	<b>277</b>

## Schott Campus

Drainage Area 1	1.73	485.00	7.70	0.01588	10.00	2.56	3.16	13.00	0.76	0.8	3.18	4.03	4	6
Drainage Area 2	1.57	572.00	7.90	0.01381	10.00	2.39	3.99	14.00	0.76	0.8	3.18	4.03	4	5
<b>Totals</b>	<b>3.30</b>												<b>8</b>	<b>11</b>

## Wake Campus

Drainage Area 1	0.50	465.00	7.80	0.01677	10.00	2.63	2.94	13.00	0.76	0.8	3.18	4.03	1	2
Drainage Area 2	2.58	453.00	4.00	0.00883	10.00	1.91	3.95	14.00	0.76	0.8	2.89	3.65	6	8
Drainage Area 3	2.27	453.00	7.00	0.01545	10.00	2.53	2.99	13.00	0.76	0.8	2.89	3.65	5	7
Drainage Area 4	4.29	820.00	26.00	0.03171	10.00	3.62	3.78	14.00	0.76	0.8	2.97	3.76	10	13
Drainage Area 5	0.65	177.00	26.00	0.14689	10.00	6.18	0.48	10.00	0.76	0.8	3.07	3.89	2	2
<b>Totals</b>	<b>10.29</b>												<b>23</b>	<b>31</b>

Pavement & small upland gullies      20.328  
 Grassed waterways                              16.135

## Santa Barbara County Flood Control and Water Conservation District

*Program Rational - XL***User Data:**

<b>Project Name:</b>	Main Campus	<b>Project Number:</b>	1500059
<b>Date of Run:</b>	4/4/2016	<b>Run By:</b>	GT
<b>Notes:</b>	Drainage Area A		

**Input Data:**

<b>Location:</b>	South Coast	<b>Land Use Type:</b>	Commercial
<b>Area (Acres):</b>	1.86	<b>Time of Concentration (Min.):</b>	12
<b>Calculated Runoff Coefficient:</b>	Q10: 0.73	Q25: 0.76	Q50: 0.79
<b>User Selected Runoff Coefficient (Optional):</b>			
			Q100: 0.80
			<b>Calculate</b>

**For Large Lot Subdivisions (>10,000 sq. ft.):**

	Low Value:	High Value:	User Selected:
Q10:			
Q25:			
Q50:			
Q100:			

**Enter Selection**

**Results:**

	Rainfall Intensity:	Runoff Coef:	Q (cfs):
Q10:	2.61	0.73	4
Q25:	3.18	0.76	4
Q50:	3.68	0.79	5
Q100:	4.03	0.80	6

**View RI Curves**      **Print**  
**View RC Curves**      **Exit**

## Santa Barbara County Flood Control and Water Conservation District

*Program Rational - XL***User Data:**

<b>Project Name:</b>	Main Campus	<b>Project Number:</b>	1500059
<b>Date of Run:</b>	4/4/2016	<b>Run By:</b>	GT
<b>Notes:</b>	Drainage Area A		

**Input Data:**

<b>Location:</b>	South Coast	<b>Land Use Type:</b>	Commercial
<b>Area (Acres):</b>	1.86	<b>Time of Concentration (Min.):</b>	12
<b>Calculated Runoff Coefficient:</b>	Q10: 0.73	Q25: 0.76	Q50: 0.79
<b>User Selected Runoff Coefficient (Optional):</b>			
			Q100: 0.80
			<b>Calculate</b>

**For Large Lot Subdivisions (>10,000 sq. ft.):**

	Low Value:	High Value:	User Selected:
Q10:			
Q25:			
Q50:			
Q100:			

**Enter Selection**

**Results:**

	Rainfall Intensity:	Runoff Coef:	Q (cfs):
Q10:	2.61	0.73	4
Q25:	3.18	0.76	4
Q50:	3.68	0.79	5
Q100:	4.03	0.80	6

**View RI Curves**      **Print**  
**View RC Curves**      **Exit**

## Santa Barbara County Flood Control and Water Conservation District

## Program Rational - XL

## User Data:

Project Name:	Main Campus	Project Number:	1500059
Date of Run:	4/4/2016	Run By:	GT
Notes:	Drainage Area B		

## Input Data:

Location:	South Coast	Land Use Type:	Commercial	
Area (Acres):	2.06	Time of Concentration (Min.):	15	
Calculated Runoff Coefficient:	Q10: 0.72	Q25: 0.75	Q50: 0.77	Q100: 0.79
User Selected Runoff Coefficient (Optional):				
				Calculate

## For Large Lot Subdivisions (&gt;10,000 sq. ft.):

	Low Value:	High Value:	User Selected:
Q10:			
Q25:			
Q50:			
Q100:			

Enter Selection

## Results:

	Rainfall Intensity:	Runoff Coef:	Q (cfs):
Q10:	2.37	0.72	4
Q25:	2.89	0.75	4
Q50:	3.32	0.77	5
Q100:	3.65	0.79	6

View RI Curves      Print

View RC Curves      Exit

## Santa Barbara County Flood Control and Water Conservation District

## Program Rational - XL

## User Data:

<b>Project Name:</b>	Main Campus	<b>Project Number:</b>	1500059
<b>Date of Run:</b>	4/4/2016	<b>Run By:</b>	GT
<b>Notes:</b>	Drainage Area C		

## Input Data:

<b>Location:</b>	South Coast	<b>Land Use Type:</b>	Commercial	
<b>Area (Acres):</b>	11.30	<b>Time of Concentration (Min.):</b>	15	
<b>Calculated Runoff Coefficient:</b>	Q10: 0.72	Q25: 0.75	Q50: 0.77	Q100: 0.79
<b>User Selected Runoff Coefficient (Optional):</b>				
				<b>Calculate</b>

## For Large Lot Subdivisions (&gt;10,000 sq. ft.):

	Low Value:	High Value:	User Selected:
Q10:			
Q25:			
Q50:			
Q100:			

**Enter Selection**

## Results:

	Rainfall Intensity:	Runoff Coef:	Q (cfs):
Q10:	2.37	0.72	19
Q25:	2.89	0.75	24
Q50:	3.32	0.77	29
Q100:	3.65	0.79	33

**View RI Curves**      **Print**  
**View RC Curves**      **Exit**



## Santa Barbara County Flood Control and Water Conservation District

*Program Rational - XL***User Data:**

<b>Project Name:</b>	Main Campus	<b>Project Number:</b>	1500059
<b>Date of Run:</b>	4/4/2016	<b>Run By:</b>	GT
<b>Notes:</b>	Drainage Area D		

**Input Data:**

<b>Location:</b>	South Coast	<b>Land Use Type:</b>	Commercial
<b>Area (Acres):</b>	5.09	<b>Time of Concentration (Min.):</b>	14
<b>Calculated Runoff Coefficient:</b>	Q10: 0.72	Q25: 0.75	Q50: 0.78
<b>User Selected Runoff Coefficient (Optional):</b>			
			Q100: 0.79
			<input type="button" value="Calculate"/>

**For Large Lot Subdivisions (>10,000 sq. ft.):**

	Low Value:	High Value:	User Selected:
Q10:			
Q25:			
Q50:			
Q100:			

**Results:**

	Rainfall Intensity:	Runoff Coef:	Q (cfs):
Q10:	2.44	0.72	9
Q25:	2.97	0.75	11
Q50:	3.43	0.78	14
Q100:	3.76	0.79	15

## Santa Barbara County Flood Control and Water Conservation District

## Program Rational - XL

## User Data:

Project Name:	Main Campus	Project Number:	1500059
Date of Run:	4/4/2016	Run By:	GT
Notes:	Drainage Area E		

## Input Data:

Location:	South Coast	Land Use Type:	Commercial		
Area (Acres):	13.44	Time of Concentration (Min.):	13		
Calculated Runoff Coefficient:	Q10: 0.73	Q25: 0.76	Q50: 0.78	Q100: 0.80	Calculate
User Selected Runoff Coefficient (Optional):					

## For Large Lot Subdivisions (&gt;10,000 sq. ft.):

	Low Value:	High Value:	User Selected:	
Q10:				Enter Selection
Q25:				
Q50:				
Q100:				

## Results:

	Rainfall Intensity:	Runoff Coef:	Q (cfs):		
Q10:	2.52	0.73	25	View RI Curves	Print
Q25:	3.07	0.76	31		
Q50:	3.55	0.78	37		
Q100:	3.89	0.80	42	View RC Curves	Exit

## Santa Barbara County Flood Control and Water Conservation District

## Program Rational - XL

## User Data:

Project Name:	Main Campus	Project Number:	1500059
Date of Run:	4/4/2016	Run By:	GT
Notes:	Drainage Area F		

## Input Data:

Location:	South Coast	Land Use Type:	Commercial
Area (Acres):	2.57	Time of Concentration (Min.):	13
Calculated Runoff Coefficient:	Q10: 0.73	Q25: 0.76	Q50: 0.78
User Selected Runoff Coefficient (Optional):			
			Q100: 0.80
			<input type="button" value="Calculate"/>

## For Large Lot Subdivisions (&gt;10,000 sq. ft.):

	Low Value:	High Value:	User Selected:
Q10:	<input type="text"/>	<input type="text"/>	<input type="text"/>
Q25:	<input type="text"/>	<input type="text"/>	<input type="text"/>
Q50:	<input type="text"/>	<input type="text"/>	<input type="text"/>
Q100:	<input type="text"/>	<input type="text"/>	<input type="text"/>

## Results:

	Rainfall Intensity:	Runoff Coef:	Q (cfs):
Q10:	2.52	0.73	5
Q25:	3.07	0.76	6
Q50:	3.55	0.78	7
Q100:	3.89	0.80	8

## Santa Barbara County Flood Control and Water Conservation District

## Program Rational - XL

## User Data:

<b>Project Name:</b>	Main Campus	<b>Project Number:</b>	1500059
<b>Date of Run:</b>	4/4/2016	<b>Run By:</b>	GT
<b>Notes:</b>	Drainage Area G		

## Input Data:

<b>Location:</b>	South Coast	<b>Land Use Type:</b>	Commercial
<b>Area (Acres):</b>	3.32	<b>Time of Concentration (Min.):</b>	13
<b>Calculated Runoff Coefficient:</b>	Q10: 0.73	Q25: 0.76	Q50: 0.78
<b>User Selected Runoff Coefficient (Optional):</b>			
			Q100: 0.80
			<input type="button" value="Calculate"/>

## For Large Lot Subdivisions (&gt;10,000 sq. ft.):

	Low Value:	High Value:	User Selected:
Q10:	<input type="text"/>	<input type="text"/>	<input type="text"/>
Q25:	<input type="text"/>	<input type="text"/>	<input type="text"/>
Q50:	<input type="text"/>	<input type="text"/>	<input type="text"/>
Q100:	<input type="text"/>	<input type="text"/>	<input type="text"/>

## Results:

	Rainfall Intensity:	Runoff Coef:	Q (cfs):
Q10:	2.52	0.73	6
Q25:	3.07	0.76	8
Q50:	3.55	0.78	9
Q100:	3.89	0.80	10

## Santa Barbara County Flood Control and Water Conservation District

## Program Rational - XL

## User Data:

<b>Project Name:</b>	Main Campus	<b>Project Number:</b>	1500059
<b>Date of Run:</b>	4/4/2016	<b>Run By:</b>	GT
<b>Notes:</b>	Drainage Area H		

## Input Data:

<b>Location:</b>	South Coast	<b>Land Use Type:</b>	Commercial
<b>Area (Acres):</b>	3.42	<b>Time of Concentration (Min.):</b>	16
<b>Calculated Runoff Coefficient:</b>	Q10: 0.72	Q25: 0.75	Q50: 0.77
<b>User Selected Runoff Coefficient (Optional):</b>			
			Q100: 0.78
			<input type="button" value="Calculate"/>

## For Large Lot Subdivisions (&gt;10,000 sq. ft.):

	Low Value:	High Value:	User Selected:
Q10:			
Q25:			
Q50:			
Q100:			

## Results:

	Rainfall Intensity:	Runoff Coef:	Q (cfs):
Q10:	2.31	0.72	6
Q25:	2.81	0.75	7
Q50:	3.23	0.77	9
Q100:	3.54	0.78	9

## Santa Barbara County Flood Control and Water Conservation District

## Program Rational - XL

## User Data:

Project Name:	Main Campus	Project Number:	1500059
Date of Run:	4/4/2016	Run By:	GT
Notes:	Drainage Area I		

## Input Data:

Location:	South Coast	Land Use Type:	Commercial	
Area (Acres):	13.99	Time of Concentration (Min.):	12	
Calculated Runoff Coefficient:	Q10: 0.73	Q25: 0.76	Q50: 0.79	Q100: 0.80
User Selected Runoff Coefficient (Optional):				

Calculate

## For Large Lot Subdivisions (&gt;10,000 sq. ft.):

	Low Value:	High Value:	User Selected:
Q10:			
Q25:			
Q50:			
Q100:			

Enter Selection

## Results:

	Rainfall Intensity:	Runoff Coef:	Q (cfs):
Q10:	2.61	0.73	27
Q25:	3.18	0.76	34
Q50:	3.68	0.79	41
Q100:	4.03	0.80	45

View RI Curves

Print

View RC Curves

Exit

## Santa Barbara County Flood Control and Water Conservation District

## Program Rational - XL

## User Data:

<b>Project Name:</b>	Main Campus	<b>Project Number:</b>	1500059
<b>Date of Run:</b>	4/4/2016	<b>Run By:</b>	GT
<b>Notes:</b>	Drainage Area J		

## Input Data:

<b>Location:</b>	South Coast	<b>Land Use Type:</b>	Commercial
<b>Area (Acres):</b>	2.41	<b>Time of Concentration (Min.):</b>	14
<b>Calculated Runoff Coefficient:</b>	Q10: 0.72	Q25: 0.75	Q50: 0.78
			Q100: 0.79
<b>User Selected Runoff Coefficient (Optional):</b>			
<b>Calculate</b>			

## For Large Lot Subdivisions (&gt;10,000 sq. ft.):

	Low Value:	High Value:	User Selected:
Q10:			
Q25:			
Q50:			
Q100:			

**Enter Selection**

## Results:

	Rainfall Intensity:	Runoff Coef:	Q (cfs):
Q10:	2.44	0.72	4
Q25:	2.97	0.75	5
Q50:	3.43	0.78	6
Q100:	3.76	0.79	7

**View RI Curves**      **Print**  
**View RC Curves**      **Exit**

## Santa Barbara County Flood Control and Water Conservation District

## Program Rational - XL

## User Data:

<b>Project Name:</b>	Main Campus	<b>Project Number:</b>	1500059
<b>Date of Run:</b>	4/4/2016	<b>Run By:</b>	GT
<b>Notes:</b>	Drainage Area K		

## Input Data:

<b>Location:</b>	South Coast	<b>Land Use Type:</b>	Commercial
<b>Area (Acres):</b>	2.76	<b>Time of Concentration (Min.):</b>	14
<b>Calculated Runoff Coefficient:</b>	Q10: 0.72	Q25: 0.75	Q50: 0.78
<b>User Selected Runoff Coefficient (Optional):</b>			
			Q100: 0.79
			<b>Calculate</b>

## For Large Lot Subdivisions (&gt;10,000 sq. ft.):

	Low Value:	High Value:	User Selected:
Q10:			
Q25:			
Q50:			
Q100:			
			<b>Enter Selection</b>

## Results:

	Rainfall Intensity:	Runoff Coef:	Q (cfs):
Q10:	2.44	0.72	5
Q25:	2.97	0.75	6
Q50:	3.43	0.78	7
Q100:	3.76	0.79	8
			<b>View RI Curves</b>
			<b>Print</b>
			<b>View RC Curves</b>
			<b>Exit</b>



# Santa Barbara County Flood Control and Water Conservation District

## Program Rational - XL

### User Data:

<b>Project Name:</b>	Main Campus	<b>Project Number:</b>	1500059
<b>Date of Run:</b>	4/4/2016	<b>Run By:</b>	GT
<b>Notes:</b>	Drainage Area L		

### Input Data:

<b>Location:</b>	South Coast	<b>Land Use Type:</b>	Commercial	
<b>Area (Acres):</b>	20.33	<b>Time of Concentration (Min.):</b>	27	
<b>Calculated Runoff Coefficient:</b>	Q10: 0.68	Q25: 0.71	Q50: 0.73	Q100: 0.75
<b>User Selected Runoff Coefficient (Optional):</b>				
<b>Calculate</b>				

### For Large Lot Subdivisions (>10,000 sq. ft.):

	Low Value:	High Value:	User Selected:
Q10:			
Q25:			
Q50:			
Q100:			

**Enter Selection**

### Results:

	Rainfall Intensity:	Runoff Coef:	Q (cfs):
Q10:	1.84	0.68	25
Q25:	2.23	0.71	32
Q50:	2.54	0.73	38
Q100:	2.81	0.75	43

**View RI Curves**      **Print**  
**View RC Curves**      **Exit**

## Santa Barbara County Flood Control and Water Conservation District

## Program Rational - XL

## User Data:

<b>Project Name:</b>	Main Campus	<b>Project Number:</b>	1500059
<b>Date of Run:</b>	4/4/2016	<b>Run By:</b>	GT
<b>Notes:</b>	Drainage Area M		

## Input Data:

<b>Location:</b>	South Coast	<b>Land Use Type:</b>	Commercial	
<b>Area (Acres):</b>	6.44	<b>Time of Concentration (Min.):</b>	12	
<b>Calculated Runoff Coefficient:</b>	Q10: 0.73	Q25: 0.76	Q50: 0.79	Q100: 0.80
<b>User Selected Runoff Coefficient (Optional):</b>				

## For Large Lot Subdivisions (&gt;10,000 sq. ft.):

	Low Value:	High Value:	User Selected:
Q10:			
Q25:			
Q50:			
Q100:			

## Results:

	Rainfall Intensity:	Runoff Coef:	Q (cfs):
Q10:	2.61	0.73	12
Q25:	3.18	0.76	16
Q50:	3.68	0.79	19
Q100:	4.03	0.80	21

## Santa Barbara County Flood Control and Water Conservation District

## Program Rational - XL

## User Data:

<b>Project Name:</b>	Main Campus	<b>Project Number:</b>	1500059
<b>Date of Run:</b>	4/4/2016	<b>Run By:</b>	GT
<b>Notes:</b>	Drainage Area N		

## Input Data:

<b>Location:</b>	South Coast	<b>Land Use Type:</b>	Commercial
<b>Area (Acres):</b>	2.46	<b>Time of Concentration (Min.):</b>	12
<b>Calculated Runoff Coefficient:</b>	Q10: 0.73	Q25: 0.76	Q50: 0.79
<b>User Selected Runoff Coefficient (Optional):</b>			
			Q100: 0.80
			<b>Calculate</b>

## For Large Lot Subdivisions (&gt;10,000 sq. ft.):

	Low Value:	High Value:	User Selected:
Q10:			
Q25:			
Q50:			
Q100:			

**Enter Selection**

## Results:

	Rainfall Intensity:	Runoff Coef:	Q (cfs):
Q10:	2.61	0.73	5
Q25:	3.18	0.76	6
Q50:	3.68	0.79	7
Q100:	4.03	0.80	8

**View RI Curves**      **Print**  
**View RC Curves**      **Exit**

## Santa Barbara County Flood Control and Water Conservation District

## Program Rational - XL

## User Data:

Project Name:	Schott Campus	Project Number:	1500059
Date of Run:	3/18/2016	Run By:	GT
Notes:	Drainage Area 1		

## Input Data:

Location:	South Coast	Land Use Type:	Commercial		
Area (Acres):	1.73	Time of Concentration (Min.):	12		
Calculated Runoff Coefficient:	Q10: 0.73	Q25: 0.76	Q50: 0.79	Q100: 0.80	Calculate
User Selected Runoff Coefficient (Optional):					

## For Large Lot Subdivisions (&gt;10,000 sq. ft.):

	Low Value:	High Value:	User Selected:	
Q10:				Enter Selection
Q25:				
Q50:				
Q100:				

## Results:

	Rainfall Intensity:	Runoff Coef:	Q (cfs):		
Q10:	2.61	0.73	3	View RI Curves	Print
Q25:	3.18	0.76	4		
Q50:	3.68	0.79	5	View RC Curves	Exit
Q100:	4.03	0.80	6		

## Santa Barbara County Flood Control and Water Conservation District

*Program Rational - XL***User Data:**

<b>Project Name:</b>	Schott Campus	<b>Project Number:</b>	1500059
<b>Date of Run:</b>	3/18/2016	<b>Run By:</b>	GT
<b>Notes:</b>	Drainage Area 2		

**Input Data:**

<b>Location:</b>	South Coast	<b>Land Use Type:</b>	Commercial
<b>Area (Acres):</b>	1.57	<b>Time of Concentration (Min.):</b>	12
<b>Calculated Runoff Coefficient:</b>	Q10: 0.73	Q25: 0.76	Q50: 0.79
<b>User Selected Runoff Coefficient (Optional):</b>			
			Q100: 0.80
			<b>Calculate</b>

**For Large Lot Subdivisions (>10,000 sq. ft.):**

	Low Value:	High Value:	User Selected:
Q10:			
Q25:			
Q50:			
Q100:			
			<b>Enter Selection</b>

**Results:**

	Rainfall Intensity:	Runoff Coef:	Q (cfs):
Q10:	2.61	0.73	3
Q25:	3.18	0.76	4
Q50:	3.68	0.79	5
Q100:	4.03	0.80	5
			<b>View RI Curves</b>
			<b>Print</b>
			<b>View RC Curves</b>
			<b>Exit</b>

# Santa Barbara County Flood Control and Water Conservation District

## Program Rational - XL

### User Data:

<b>Project Name:</b>	Wake Campus	<b>Project Number:</b>	1500059
<b>Date of Run:</b>	3/18/2016	<b>Run By:</b>	GT
<b>Notes:</b>	Drainage Area 1		

### Input Data:

<b>Location:</b>	South Coast	<b>Land Use Type:</b>	Commercial
<b>Area (Acres):</b>	0.50	<b>Time of Concentration (Min.):</b>	12
<b>Calculated Runoff Coefficient:</b>	Q10: 0.73	Q25: 0.76	Q50: 0.79
<b>User Selected Runoff Coefficient (Optional):</b>			
			Q100: 0.80
			<b>Calculate</b>

### For Large Lot Subdivisions (>10,000 sq. ft.):

	Low Value:	High Value:	User Selected:
Q10:			
Q25:			
Q50:			
Q100:			

**Enter Selection**

### Results:

	Rainfall Intensity:	Runoff Coef:	Q (cfs):
Q10:	2.61	0.73	1
Q25:	3.18	0.76	1
Q50:	3.68	0.79	1
Q100:	4.03	0.80	2

**View RI Curves**      **Print**  
**View RC Curves**      **Exit**

## Santa Barbara County Flood Control and Water Conservation District

*Program Rational - XL***User Data:**

<b>Project Name:</b>	Wake Campus	<b>Project Number:</b>	1500059
<b>Date of Run:</b>	3/18/2016	<b>Run By:</b>	GT
<b>Notes:</b>	Drainage Area 2		

**Input Data:**

<b>Location:</b>	South Coast	<b>Land Use Type:</b>	Commercial
<b>Area (Acres):</b>	2.58	<b>Time of Concentration (Min.):</b>	12
<b>Calculated Runoff Coefficient:</b>	Q10: 0.73	Q25: 0.76	Q50: 0.79
<b>User Selected Runoff Coefficient (Optional):</b>			
			Q100: 0.80
			<input type="button" value="Calculate"/>

**For Large Lot Subdivisions (>10,000 sq. ft.):**

	Low Value:	High Value:	User Selected:
Q10:			
Q25:			
Q50:			
Q100:			

**Results:**

	Rainfall Intensity:	Runoff Coef:	Q (cfs):
Q10:	2.61	0.73	5
Q25:	3.18	0.76	6
Q50:	3.68	0.79	8
Q100:	4.03	0.80	8

## Santa Barbara County Flood Control and Water Conservation District

## Program Rational - XL

## User Data:

<b>Project Name:</b>	Wake Campus	<b>Project Number:</b>	1500059
<b>Date of Run:</b>	3/18/2016	<b>Run By:</b>	GT
<b>Notes:</b>	Drainage Area 3		

## Input Data:

<b>Location:</b>	South Coast	<b>Land Use Type:</b>	Commercial
<b>Area (Acres):</b>	2.27	<b>Time of Concentration (Min.):</b>	12
<b>Calculated Runoff Coefficient:</b>	Q10: 0.73	Q25: 0.76	Q50: 0.79
<b>User Selected Runoff Coefficient (Optional):</b>			
			Q100: 0.80
			<input type="button" value="Calculate"/>

## For Large Lot Subdivisions (&gt;10,000 sq. ft.):

	Low Value:	High Value:	User Selected:
Q10:			
Q25:			
Q50:			
Q100:			

## Results:

	Rainfall Intensity:	Runoff Coef:	Q (cfs):
Q10:	2.61	0.73	4
Q25:	3.18	0.76	5
Q50:	3.68	0.79	7
Q100:	4.03	0.80	7



## Santa Barbara County Flood Control and Water Conservation District

## Program Rational - XL

## User Data:

Project Name:	Wake Campus	Project Number:	1500059
Date of Run:	3/18/2016	Run By:	GT
Notes:	Drainage Area 4		

## Input Data:

Location:	South Coast	Land Use Type:	Commercial	
Area (Acres):	4.29	Time of Concentration (Min.):	12	
Calculated Runoff Coefficient:	Q10: 0.73	Q25: 0.76	Q50: 0.79	Q100: 0.80
User Selected Runoff Coefficient (Optional):				
				Calculate

## For Large Lot Subdivisions (&gt;10,000 sq. ft.):

	Low Value:	High Value:	User Selected:
Q10:			
Q25:			
Q50:			
Q100:			

Enter Selection

## Results:

	Rainfall Intensity:	Runoff Coef:	Q (cfs):
Q10:	2.61	0.73	8
Q25:	3.18	0.76	10
Q50:	3.68	0.79	12
Q100:	4.03	0.80	14

View RI Curves      Print

View RC Curves      Exit



## Santa Barbara County Flood Control and Water Conservation District

### *Program Rational - XL*

#### User Data:

<b>Project Name:</b>	Wake Campus	<b>Project Number:</b>	1500059
<b>Date of Run:</b>	3/18/2016	<b>Run By:</b>	GT
<b>Notes:</b>	Drainage Area 5		

#### Input Data:

<b>Location:</b>	South Coast	<b>Land Use Type:</b>	Commercial
<b>Area (Acres):</b>	0.65	<b>Time of Concentration (Min.):</b>	12
<b>Calculated Runoff Coefficient:</b>	Q10: 0.73	Q25: 0.76	Q50: 0.79
<b>User Selected Runoff Coefficient (Optional):</b>			Q100: 0.80

#### For Large Lot Subdivisions (>10,000 sq. ft.):

	Low Value:	High Value:	User Selected:
Q10:	<input type="text"/>	<input type="text"/>	<input type="text"/>
Q25:	<input type="text"/>	<input type="text"/>	<input type="text"/>
Q50:	<input type="text"/>	<input type="text"/>	<input type="text"/>
Q100:	<input type="text"/>	<input type="text"/>	<input type="text"/>

#### Results:

	Rainfall Intensity:	Runoff Coef:	Q (cfs):
Q10:	2.61	0.73	1
Q25:	3.18	0.76	2
Q50:	3.68	0.79	2
Q100:	4.03	0.80	2

# Topography Survey

**Date of Aerial Flight:**  
NOVEMBER 30, 2015

**Date of Plan:**  
MARCH 4, 2016

**Address:**  
310 W PADRE ST, SANTA BARBARA, CA 93105

**Assessor's Parcel Number:**  
A.P.N. 025-222-007

**Horizontal Datum Reference:**  
THE BEARINGS SHOWN HEREON ARE BASED ON THE CALIFORNIA STATE PLANE COORDINATE SYSTEM - NAD 83 (2011). ZONE V AS COMPUTED FROM GPS STATIC OBSERVATIONS USING STANDARD SURVEY PROCEDURES WHICH WERE ADJUSTED USING NGS-OPUS UTILITY.

**Boundary and Easements:**  
ESTABLISHED PER PRELIMINARY TITLE REPORT (PTR) PREPARED BY FIRST AMERICAN TITLE COMPANY, DATED JANUARY 5, 2016, ORDER NO. 4206-5059025, ADJUSTED TO FOUND CITY CENTERLINE MONUMENTS, USING STANDARD SURVEYING PROCEDURES.

**Bench Mark:**  
THE ELEVATION OF 120.48 ON BENCH MARK 820 (CHISELED SQUARE ON TOP OF CURB, SOUTHERLY SIDE OF W. PADRE ST, 40' WESTERLY OF RETURN, IN FRONT OF FRONT DOOR TO 403 W. PADRE ST) NAVD 88 - 2000 ADJUSTMENT WAS USED AS THE DATUM FOR THIS SURVEY.

**Legal Description:**  
REAL PROPERTY IN THE CITY OF SANTA BARBARA, COUNTY OF SANTA BARBARA, STATE OF CALIFORNIA, DESCRIBED AS FOLLOWS:  
PARCEL 1:  
THAT PORTION OF BLOCK NINE (9) OF NEALE'S ADDITION TO THE TOWN OF SANTA BARBARA, IN THE CITY OF SANTA BARBARA, COUNTY OF SANTA BARBARA, STATE OF CALIFORNIA, ACCORDING TO THE MAP THEREOF FILED IN BOOK "B", PAGE 139 OF MISCELLANEOUS RECORDS IN THE OFFICE OF THE SANTA BARBARA COUNTY RECORDER, DESCRIBED AS FOLLOWS:  
BEGINNING AT THE MOST SOUTHERLY CORNER OF SAID BLOCK NINE (9), BEING THE INTERSECTION OF NORTHWESTERLY LINE OF PADRE STREET (FORMERLY FIRST AVENUE WITH THE NORTHEASTERLY LINE OF THE CASTILLO STREET; THENCE NORTHWESTERLY ALONG THE NORTHEASTERLY LINE OF CASTILLO STREET, PARALLEL WITH BATH STREET, 225 FEET TO THE CENTER OF SAID BLOCK; THENCE AT RIGHT ANGLES INTO SAID BLOCK NORTHEASTERLY AND PARALLEL WITH SAID PADRE STREET, 225 FEET TO THE CENTER OF SAID BLOCK; THENCE AT RIGHT ANGLES SOUTHEASTERLY AND PARALLEL WITH SAID CASTILLO STREET, 225 FEET TO THE NORTHWESTERLY LINE OF SAID PADRE STREET; THENCE AT RIGHT ANGLES NORTHWESTERLY ALONG SAID NORTHWESTERLY LINE OF PADRE STREET 225 FEET TO THE POINT OF BEGINNING; AND BEING THE SOUTH QUARTER OF SAID BLOCK NINE.

PARCEL 2:  
THAT PORTION OF BLOCK NINE (9) OF NEALE'S ADDITION TO THE TOWN OF SANTA BARBARA, IN THE CITY OF SANTA BARBARA, COUNTY OF SANTA BARBARA, STATE OF CALIFORNIA, ACCORDING TO THE MAP THEREOF FILED IN BOOK "B", PAGE 139 OF MISCELLANEOUS RECORDS IN THE OFFICE OF THE SANTA BARBARA COUNTY RECORDER, DESCRIBED AS FOLLOWS:  
BEGINNING AT THE MOST SOUTHERLY CORNER OF SAID BLOCK NINE (9), BEING THE INTERSECTION OF NORTHWESTERLY LINE OF PADRE STREET (FORMERLY FIRST AVENUE WITH THE NORTHEASTERLY LINE OF THE CASTILLO STREET; THENCE NORTHWESTERLY ALONG THE NORTHEASTERLY LINE OF CASTILLO STREET, PARALLEL WITH BATH STREET, 225 FEET TO THE CENTER OF SAID BLOCK; THENCE AT RIGHT ANGLES INTO SAID BLOCK NORTHEASTERLY AND PARALLEL WITH SAID PADRE STREET, 225 FEET TO THE CENTER OF SAID BLOCK; THENCE AT RIGHT ANGLES SOUTHEASTERLY AND PARALLEL WITH SAID CASTILLO STREET, 225 FEET TO THE NORTHWESTERLY LINE OF SAID PADRE STREET; THENCE AT RIGHT ANGLES NORTHWESTERLY ALONG SAID NORTHWESTERLY LINE OF PADRE STREET 225 FEET TO THE POINT OF BEGINNING; AND BEING THE SOUTH QUARTER OF SAID BLOCK NINE.

PARCEL 3:  
THAT PORTION OF BLOCK NINE (9) OF NEALE'S ADDITION TO THE TOWN OF SANTA BARBARA, IN THE CITY OF SANTA BARBARA, COUNTY OF SANTA BARBARA, STATE OF CALIFORNIA, ACCORDING TO THE MAP THEREOF FILED IN BOOK "B", PAGE 139 OF MISCELLANEOUS RECORDS IN THE OFFICE OF THE SANTA BARBARA COUNTY RECORDER, DESCRIBED AS FOLLOWS:  
BEGINNING AT THE MOST EASTERLY CORNER OF SAID BLOCK NINE (9), BEING THE INTERSECTION OF THE SOUTHWESTERLY LINE OF BATH STREET WITH THE NORTHWESTERLY LINE OF PADRE STREET (FORMERLY FIRST AVENUE); THENCE NORTHWESTERLY ALONG THE SOUTHWESTERLY LINE OF BATH STREET 225 FEET; THENCE AT RIGHT ANGLES SOUTHWESTERLY INTO SAID BATH STREET 225 FEET; THENCE AT RIGHT ANGLES SOUTHEASTERLY 225 FEET TO THE NORTHWESTERLY LINE OF SAID PADRE STREET; THENCE AT RIGHT ANGLES NORTHWESTERLY ALONG SAID NORTHWESTERLY LINE OF PADRE STREET 225 FEET TO THE POINT OF BEGINNING; AND BEING THE EAST QUARTER OF SAID BLOCK NINE.

PARCEL 4:  
OF BLOCK NINE (9) OF NEALE'S ADDITION TO THE TOWN OF SANTA BARBARA, IN THE CITY OF SANTA BARBARA, COUNTY OF SANTA BARBARA, STATE OF CALIFORNIA, ACCORDING TO THE MAP THEREOF FILED IN BOOK "B", PAGE 139 OF MISCELLANEOUS RECORDS IN THE OFFICE OF THE SANTA BARBARA COUNTY RECORDER, DESCRIBED AS FOLLOWS:  
BEGINNING AT A POINT ON THE SOUTHWESTERLY LINE OF BATH STREET, DISTANT THEREON 175 FEET SOUTHEASTERLY FROM THE NORTHWESTERLY CORNER OF SAID BLOCK; THENCE SOUTHEASTERLY ALONG SAID STREET LINE 50 FEET; THENCE AT RIGHT ANGLES SOUTHWESTERLY 225 FEET; THENCE AT RIGHT ANGLES NORTHWESTERLY 50 FEET; TO THE SOUTHEASTERLY LINE OF A 15'-FOOT ALLEY; THENCE AT RIGHT ANGLES NORTHWESTERLY, ALONG SAID LINE OF SAID ALLEY AND THE LINE OF THE LAND DEEDED BY MELLZENA A. HURLBUT AND J. L. HURLBUT, HER HUSBAND, TO KAETHRYN A. VERNOLD, BY DEED DATED FEBRUARY 16, 1914 AND RECORDED MARCH 2, 1914 IN BOOK 142, PAGE 562 OF DEEDS; 225 FEET TO THE POINT OF BEGINNING.

PARCEL 5:  
THAT PORTION OF BLOCK NINE (9) OF NEALE'S ADDITION TO THE TOWN OF SANTA BARBARA, IN THE CITY OF SANTA BARBARA, COUNTY OF SANTA BARBARA, STATE OF CALIFORNIA, ACCORDING TO THE MAP THEREOF FILED IN BOOK "B", PAGE 139 OF MISCELLANEOUS RECORDS IN THE OFFICE OF THE SANTA BARBARA COUNTY RECORDER, DESCRIBED AS FOLLOWS:  
BEGINNING AT A POINT ON THE NORTHWESTERLY LINE OF CASTILLO STREET DISTANT THEREON 175 FEET SOUTHEASTERLY FROM THE WEST CORNER OF SAID BLOCK; THENCE SOUTHEASTERLY ALONG THE SAID NORTHWESTERLY LINE OF CASTILLO STREET 50 FEET; THENCE AT RIGHT ANGLES NORTHWESTERLY INTO SAID BLOCK 225 FEET; THENCE AT RIGHT ANGLES NORTHWESTERLY 50 FEET TO THE LINE OF AN ALLEY 15 FEET IN WIDTH; THENCE AT RIGHT ANGLES SOUTHWESTERLY ALONG THE LINE OF SAID ALLEY, AND ITS PROLONGATION, 225 FEET TO THE POINT OF BEGINNING.

PARCEL 6:  
THAT PORTION OF BLOCK NINE (9) OF NEALE'S ADDITION TO THE TOWN OF SANTA BARBARA, IN THE CITY OF SANTA BARBARA, COUNTY OF SANTA BARBARA, STATE OF CALIFORNIA, ACCORDING TO THE MAP THEREOF FILED IN BOOK "B", PAGE 139 OF MISCELLANEOUS RECORDS IN THE OFFICE OF THE SANTA BARBARA COUNTY RECORDER, DESCRIBED AS FOLLOWS:  
BEGINNING AT A POINT ON THE NORTHWESTERLY LINE OF CASTILLO STREET DISTANT THEREON 175 FEET SOUTHEASTERLY FROM THE WEST CORNER OF SAID BLOCK; THENCE SOUTHEASTERLY ALONG THE SAID NORTHWESTERLY LINE OF CASTILLO STREET 50 FEET; THENCE AT RIGHT ANGLES NORTHWESTERLY INTO SAID BLOCK 225 FEET; THENCE AT RIGHT ANGLES NORTHWESTERLY 50 FEET TO THE LINE OF AN ALLEY 15 FEET IN WIDTH; THENCE AT RIGHT ANGLES SOUTHWESTERLY ALONG THE LINE OF SAID ALLEY, AND ITS PROLONGATION, 225 FEET TO THE POINT OF BEGINNING.

PARCEL 7:  
AN EASEMENT FOR SECONDARY VEHICULAR AND PEDESTRIAN INGRESS AND EGRESS, FOR TRASH REMOVAL PURPOSES IN, ON, OVER, ALONG, THROUGH AND ACROSS THE FOLLOWING TRACT OF LAND AS GRANTED IN DEED RECORDED SEPTEMBER 20, 1994 AS INSTRUMENT NO. 94-071780 OF OFFICIAL RECORDS:  
BEGINNING AT A POINT IN THE SOUTHEASTERLY LINE OF LOS OLIVOS STREET, FORMERLY SECOND AVENUE, DISTANT THEREON 140 FEET NORTHWESTERLY FROM THE MOST WESTERLY CORNER OF SAID BLOCK; SAID POINT BEING THE MOST WESTERLY CORNER OF THE TRACT OF LAND DESCRIBED IN THE DEED TO ARTHUR M. AMES RECORDED OCTOBER 30, 1905 IN BOOK 112 OF DEEDS AT PAGE 190, IN THE OFFICE OF THE COUNTY RECORDER OF SAID COUNTY;

PARCEL 8:  
THENCE SOUTHEASTERLY, PARALLEL WITH THE SOUTHWESTERLY LINE OF CASTILLO STREET AND ALONG THE LINE OF A 15 FOOT ALLEY, AND ALONG THE SOUTHWESTERLY LINE OF SAID AMES TRACT A DISTANCE OF 160 FEET TO THE MOST SOUTHERLY CORNER OF SAID AMES TRACT;  
THENCE SOUTHEASTERLY ALONG THE SOUTHEASTERLY EXTENSION OF SAID SOUTHWESTERLY LINE OF SAID AMES TRACT A DISTANCE OF 15 FEET TO THE NORTHWESTERLY LINE OF THE TRACT OF LAND DESCRIBED IN THE DEED TO SUSAN A. JENNINGS RECORDED MARCH 1, 1906 IN BOOK 114 OF DEEDS AT PAGE 47 IN THE OFFICE OF THE COUNTY RECORDER OF SAID COUNTY;

THENCE SOUTHWESTERLY ALONG SAID ALLEY AND THE NORTHWESTERLY LINE OF SAID JENNINGS TRACT A DISTANCE OF 15 FEET TO AN ANGLE POINT IN ALLEY;  
THENCE NORTHWESTERLY ALONG THE ALLEY A DISTANCE OF 175 FEET TO THE MOST NORTHERLY CORNER OF THE TRACT OF LAND DESCRIBED IN THE DEED TO MARY D. WESCOTT RECORDED JUNE 23, 1905 IN BOOK 108 OF DEEDS AT PAGE 34, IN THE OFFICE OF THE COUNTY RECORDER OF SAID COUNTY AND A POINT IN THE SOUTHEASTERLY LINE OF LOS OLIVOS STREET;

THENCE NORTHWESTERLY ALONG SAID SOUTHEASTERLY LINE OF LOS OLIVOS STREET 15 FEET TO THE POINT OF BEGINNING.

PARCEL 9:  
AN EASEMENT FOR SECONDARY VEHICULAR AND PEDESTRIAN INGRESS AND EGRESS PURPOSES OVER THOSE PORTIONS OF PARCEL 2 OF FINAL MAP NO. 20,603, RECORDED IN BOOK 182, PAGES 80 AND 81 OF MAPS, IN THE OFFICE OF THE COUNTY RECORDER, COUNTY OF SANTA BARBARA, STATE OF CALIFORNIA, AS GRANTED IN DEED RECORDED DECEMBER 7, 1998 AS INSTRUMENT NO. 98-0095101 OF OFFICIAL RECORDS, MORE PARTICULARLY DESCRIBED AS FOLLOWS:  
BEGINNING THE SOUTHWESTERLY CORNER OF SAID PARCEL 2 BEING A POINT ON THE SOUTHEASTERLY LINE OF WEST LOS OLIVOS STREET AS SHOWN ON SAID MAP;

THENCE NORTH 41° 30' 00" EAST, ALONG SAID LINE OF WEST LOS OLIVOS STREET, 21.18 FEET;  
THENCE SOUTH 48° 30' 00" EAST 50.20 FEET TO AN ANGLE POINT;  
THENCE SOUTH 77° 19' 38" EAST 28.60 FEET TO AN ANGLE POINT;  
THENCE SOUTH 48° 30' 00" EAST 99.92 TO AN A POINT ON THE SOUTHEASTERLY LINE OF SAID PARCEL 2;  
THENCE SOUTH 41° 30' 00" WEST, ALONG SAID LINE OF PARCEL 2 STREET, 15.00 FEET;  
THENCE NORTH 48° 30' 00" WEST 96.07 FEET TO AN ANGLE POINT;  
THENCE NORTH 77° 19' 38" WEST 28.60 FEET TO AN ANGLE POINT;  
THENCE SOUTH 41° 30' 00" WEST 6.25 FEET TO A POINT ON THE A PORTION OF THE SOUTHWESTERLY LINE OF SAID PARCEL 2  
THENCE NORTH 48° 30' 00" WEST, ALONG THE SOUTHWESTERLY LINE OF SAID PARCEL 2, 54.00 FEET TO THE POINT OF BEGINNING.

THENCE NORTH 41° 30' 00" WEST, ALONG THE SOUTHWESTERLY LINE OF SAID PARCEL 2, 54.00 FEET TO THE POINT OF BEGINNING.

THENCE SOUTH 48° 30' 00" EAST 50.20 FEET TO AN ANGLE POINT;  
THENCE SOUTH 77° 19' 38" EAST 28.60 FEET TO AN ANGLE POINT;  
THENCE SOUTH 48° 30' 00" EAST 99.92 TO AN A POINT ON THE SOUTHEASTERLY LINE OF SAID PARCEL 2;  
THENCE SOUTH 41° 30' 00" WEST, ALONG SAID LINE OF PARCEL 2 STREET, 15.00 FEET;  
THENCE NORTH 48° 30' 00" WEST 96.07 FEET TO AN ANGLE POINT;  
THENCE NORTH 77° 19' 38" WEST 28.60 FEET TO AN ANGLE POINT;  
THENCE SOUTH 41° 30' 00" WEST 6.25 FEET TO A POINT ON THE A PORTION OF THE SOUTHWESTERLY LINE OF SAID PARCEL 2  
THENCE NORTH 48° 30' 00" WEST, ALONG THE SOUTHWESTERLY LINE OF SAID PARCEL 2, 54.00 FEET TO THE POINT OF BEGINNING.

### Aerial Legend:

- AC = Asphalt Concrete
- ACU = Air Conditioner Unit
- BX = Box
- CB = Catch Basin
- CBX = Communications Box
- CMP = Corrugated Metal Pipe
- CO = Clean Out
- CONC = Concrete
- DWY = Driveway
- EBX = Electric Box
- ELEC = Electric
- GP = Guard Post
- GV = Gas Valve
- PLTR = Planter
- PP = Power Pole
- SCO = Sewer Clean Out
- SMH = Sewer Manhole
- VLT = Utility Vault
- WM = Water Meter
- WV = Water Valve
- WW = Wing Wall
- Handicap Parking
- Fire Hydrant
- Manhole
- Utility Box
- Palm
- Tree
- Tree Line
- Brush Line
- Dirt Road
- Edge of Asphalt
- Concrete
- Resurface
- Trail
- Curb
- Gutter
- Chainlink Fence
- Contours
- Contours (Approximate, below tree line)
- Light Pole
- Post
- Power Pole Anchor
- Power Pole
- Traffic Signal
- Street Lights
- Large Sign
- Small Sign
- Catch Basin
- Right Turn Arrow
- Left Turn Arrow
- Misc Utility
- Water Meter
- Water Valve

THIS MAP IS AN AERIAL TOPOGRAPHY SURVEY, GENERATED FROM AERIAL PHOTOGRAMMETRY METHODS AND COMPILED WITH MAP ACCURACY STANDARDS FROM STATE AND FEDERAL GOVERNMENTS ON SURVEYING AND MAPPING PRINTED BY U.S. DEPARTMENT OF THE INTERIOR, EXCEPT WHERE OTHERWISE NOT INDICATED. AREAS OF HEAVY TREES, CLEAR AREAS IN-BETWEEN TREES WITH NO STEREO IMAGES, NEAR BRUSH, NEAR SHADOW, OR BLIND AREAS IN THE BACK OF SOME STRUCTURES.

**DRAINAGE AREA 1**  
**1.73 AC**  
**L=485'**  
**H=7.7'**  
**S=1.59%**  
**Tc=12**

**DRAINAGE AREA 2**  
**1.57 AC**  
**L=572'**  
**H=7.9'**  
**S=1.38%**  
**Tc=12**

Survey Prepared For:

Santa Barbara City College  
721 Cliff Drive  
Santa Barbara, CA 93109

Survey Prepared By:

Hahn and Associates, Inc.  
26074 Avenue Hall, Suite 2  
Santa Clarita, CA 91355  
(661) 775-9500



**DRAINAGE AREA 2**  
 2.58 AC  
 L=453'  
 H=4'  
 S=0.88%  
 c=.85

**DRAINAGE AREA 4**  
 4.29 AC  
 L=820'  
 H=26'  
 S=3.17%  
 imp=.57

**Topography**  
 Santa Barbara City College -

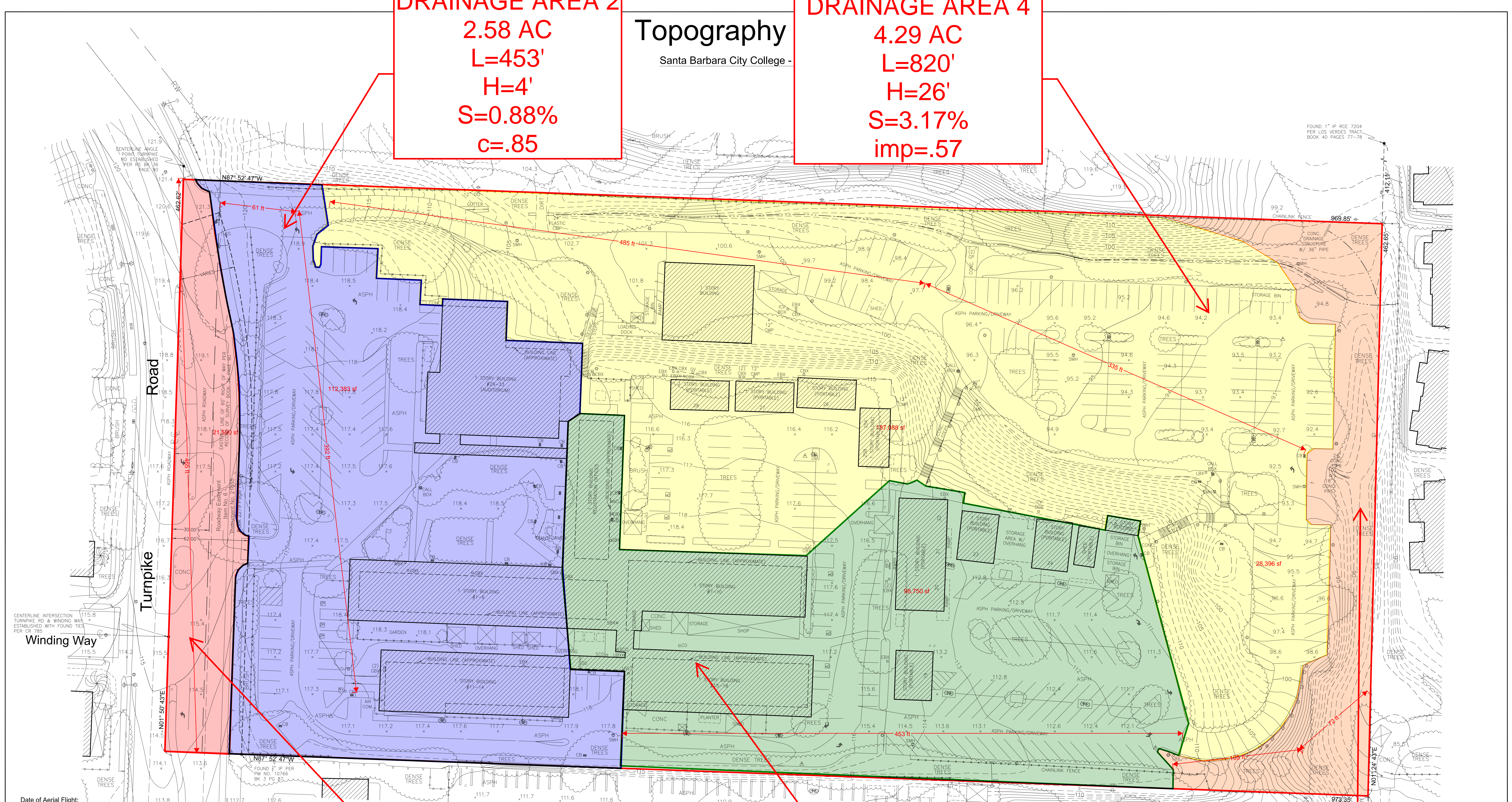

**DRAINAGE AREA 1**  
 0.50 AC  
 L= 465'  
 H=7.8  
 S=1.68%  
 c=.95

**DRAINAGE AREA 3**  
 2.27 AC  
 L=453'  
 H=7'  
 S=1.55%  
 c=.85

**DRAINAGE AREA 5**  
 0.65 AC  
 L=177'  
 H=26'  
 S=14.69%  
 imp=.10

**Date of Aerial Flight:**  
 NOVEMBER 30, 2015

**Date of Plan:**  
 MARCH 9, 2016

**Site Address:**  
 300 N TURNPIKE RD, SANTA BARBARA, CA 93111

**Assessor's Parcel Number:**  
 A.P.N.: 067-230-010

**Horizontal Datum Reference:**  
 THE BARRIERS SHOWN HEREON ARE BASED ON THE CALIFORNIA STATE PLANE COORDINATE SYSTEM COMPUTED FROM GPS STATIC OBSERVATIONS USING STANDARD SURVEY PROCEDURES

**Boundary and Easements:**  
 ESTABLISHED PER PRELIMINARY TITLE REPORT (PTR) PREPARED BY FIRST AMERICAN TITLE COMPANY, ORDER NO. 4206-5059012, ADJUSTED TO FOUND CITY CENTERLINE MONUMENTS, USING THE FOLLOWING:

**Bench Mark:**  
 THE ELEVATIONS SHOWN HEREON ARE BASED ON THE NAVD 88 DATUM (GEOID 128) AS ESTABLISHED BY THE NATIONAL GEODETIC SURVEY. NO ADJUSTMENTS WERE MADE TO THIS SURVEY.

**Legal Description:**  
 REAL PROPERTY IN THE UNINCORPORATED AREA OF THE COUNTY OF SANTA BARBARA, CALIFORNIA, DESCRIBED AS:

THAT PORTION OF LOT 1 IN TRACT "C" OF THE RANCHO LA COLETA, IN THE COUNTY OF SANTA BARBARA, CALIFORNIA, ACCORDING TO THE PARTITION SURVEY AND MAP OF SAID RANCHO MADE BY EDMUND PEW, ON FILE IN THE OFFICE OF THE COUNTY CLERK OF SAID COUNTY AND STATE IN THE MATTER OF THE ESTATE OF DANIEL A. HILL, DECEASED (CASE NO. 8989), DESCRIBED AS FOLLOWS:

BEGINNING AT POST NO. 4 OF SAID PARTITION MAP AND SURVEY, THENCE 1ST, SOUTH 02°26' WEST ALONG THE EAST LINE OF SAID RANCHO 482.65 FEET TO A 3/8" SURVEY PIPE, FROM WHICH A 1/2" SURVEY PIPE OF SAID EAST LINE BEARS NORTH 02°26' EAST 19.60 FEET; THENCE 2ND, NORTH 88°13'01" WEST PARALLEL WITH THE NORTH LINE OF SAID LOT 1 IN TRACT "C" 973.35 FEET TO THE CENTERLINE OF TURNPIKE ROAD FROM WHICH A 3/8" SURVEY PIPE SET ON THE EAST LINE OF SAID BEARS SOUTH 88°51'30" EAST 30.00 FEET; THENCE 3RD, ALONG THE CENTERLINE OF TURNPIKE ROAD, NORTH 02°52' EAST 462.62 FEET TO THE NORTHWESTERLY CORNER OF THE TRACT OF LAND DESCRIBED IN THE DEED TO KATHERINE ROWE, DATED AND RECORDED MARCH 5TH, 1917 IN BOOK 155 AT PAGE 527 OF DEEDS, FROM WHICH A 3/8" SURVEY PIPE BEARS SOUTH 88°51'30" EAST 969.85 FEET TO THE POINT OF BEGINNING.

**Survey Prepared For:**  
 Santa Barbara City College  
 721 Cliff Drive  
 Santa Barbara, CA 93109

**Survey Prepared By:**  
 Hahn and Associates, Inc.  
 26074 Avenue Hall, Suite 2  
 Santa Clarita, CA 91355  
 (661) 775-9500

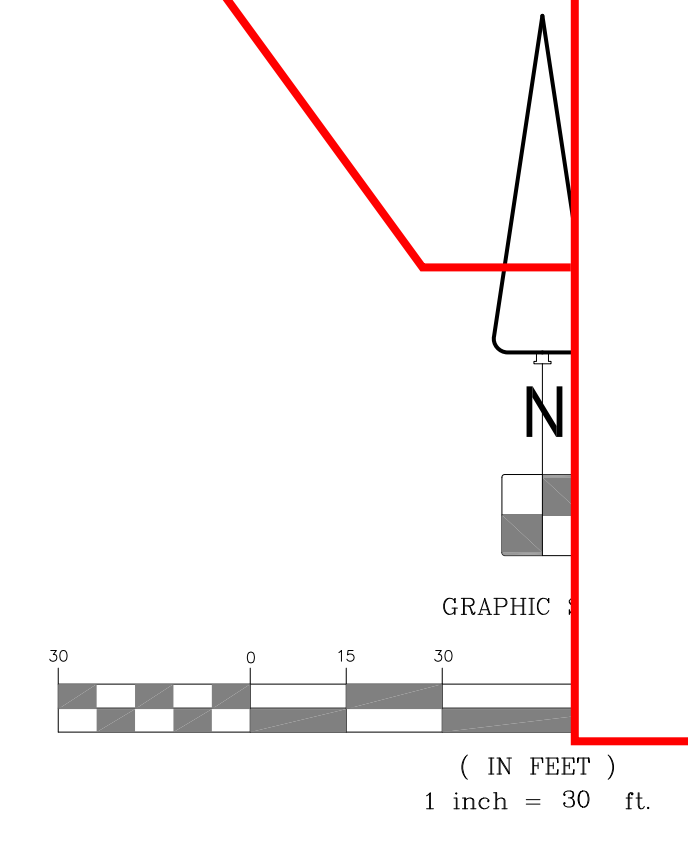

- Horizontal and Vertical Control Point
- Flag Pole
- Light Pole
- Post
- Power Pole Anchor
- Power Pole
- Street Lights
- Large Sign
- Small Sign
- Callbox
- Ditch Basin
- Left Turn Arrow
- Right Turn Arrow
- Gas Valve Cover
- Water Meter

HEAVY BRUSH, HEAVY SHADOW, OR BLIND AREAS IN THE BACK OF SOME STRUCTURES.

# Sewage Demand

Project Name: Santa Barbara City College

## Existing Wastewater Generation

Building Name	Building Type	Units of Measure	Number of Units, Seats or Area	Sewage Generation Factor (GPD)	Generated GPD	GPM	Peak GPM*	Peak CFS
<b>Main Campus</b>								
Administration			45,594					
	Classrooms	Student*	18,000	18	16,200.00	11.25	39.38	0.0898
	Laboratories	Area	13,535	0.25	3,383.75	2.35	8.22	0.0188
Business Communications	Offices	Area	14,059	0.15	2,108.85	1.46	5.13	0.0117
			22,773			-	-	-
	Classrooms	Student*	8,500	18	7,650.00	5.31	18.59	0.0424
Campus Center	Laboratories	Area	6,719	0.25	1,679.75	1.17	4.08	0.0093
	Offices	Area	7,554	0.15	1,133.10	0.79	2.75	0.0063
			2,330			-	-	-
East Campus Classroom/Office Building	Classrooms	Student*	2,330	18	2,097.00	1.46	5.10	0.0116
	Laboratories	Area	-			-	-	-
	Offices	Area	-			-	-	-
ESL Center			60,000					
	Classrooms	Student*	30,000	18	27,000.00	18.75	65.63	0.1496
	Laboratories	Area	-			-	-	-
Humanities	Offices	Area	30,000	0.15	4,500.00	3.13	10.94	0.0249
			3,091			-	-	-
	Classrooms	Student*	-			-	-	-
Interdisciplinary	Laboratories	Area	-			-	-	-
	Offices	Area	3,091	0.15	463.65	0.32	1.13	0.0026
			15,940			-	-	-
Library/LRC	Classrooms	Student*	9,000	18	8,100.00	5.63	19.69	0.0449
	Laboratories	Area	5,410	0.25	1,352.50	0.94	3.29	0.0075
	Offices	Area	1,530	0.15	229.50	0.16	0.56	0.0013
Occupational Education			23,220			-	-	-
	Classrooms	Student*	13,900	18	12,510.00	8.69	30.41	0.0693
	Laboratories	Area	1,600	0.25	400.00	0.28	0.97	0.0022
Student Services	Offices	Area	7,720	0.15	1,158.00	0.80	2.81	0.0064
			41,007			-	-	-
	Classrooms	Student*	-			-	-	-
West Campus Classroom Building	Laboratories	Area	-			-	-	-
	Offices	Area	41,007	0.15	6,151.05	4.27	14.95	0.0341
			14,899			-	-	-
Faculty Resources Center	Classrooms	Student*	3,400	18	3,060.00	2.13	7.44	0.0170
	Laboratories	Area	9,256	0.25	2,314.00	1.61	5.62	0.0128
	Offices	Area	2,243	0.15	336.45	0.23	0.82	0.0019
International Student Services Center			18,698			-	-	-
	Classrooms	Student*	-			-	-	-
	Laboratories	Area	-			-	-	-
ECOC1	Offices	Area	18,698	0.15	2,804.70	1.95	6.82	0.0155
			22,660			-	-	-
	Classrooms	Student*	20,900	18	18,810.00	13.06	45.72	0.1042
ECOC2	Laboratories	Area	-			-	-	-
	Offices	Area	1,760	0.15	264.00	0.18	0.64	0.0015
			-			-	-	-
International Student Services Center	Offices	Area	1,824	0.15	273.60	0.19	0.67	0.0015
ECOC1	Offices	Area	1,259	0.15	188.85	0.13	0.46	0.0010
ECOC2	Offices	Area	1,142	0.15	171.30	0.12	0.42	0.0009
ECOC2	Offices	Area	1,126	0.15	168.90	0.12	0.41	0.0009

ECOC3	Offices	Area	432	0.15	64.80	0.05	0.16	0.0004
ECOC4	Offices	Area	420	0.15	63.00	0.04	0.15	0.0003
ECC-4	Offices	Area	1,068	0.15	160.20	0.11	0.39	0.0009
ECC-14	Classrooms	Student*	1,196	18	1,076.40	0.75	2.62	0.0060
ECC-15	Classrooms	Student*	1,235	18	1,111.50	0.77	2.70	0.0062
ECC-16	Offices	Area	912	0.15	136.80	0.10	0.33	0.0008
ECC-17	Offices	Area	912	0.15	136.80	0.10	0.33	0.0008
ECC-18	Offices	Area	912	0.15	136.80	0.10	0.33	0.0008
ECC-19	Offices	Area	912	0.15	136.80	0.10	0.33	0.0008
ECC-20	Offices	Area	912	0.15	136.80	0.10	0.33	0.0008
ECC-21	Offices	Area	912	0.15	136.80	0.10	0.33	0.0008
<b>Totals</b>					<b>127,805.65</b>	<b>88.75</b>	<b>310.64</b>	<b>0.71</b>

### Schott Campus

Schott Center Main	Office	Area	16,212	0.15	2,431.80	1.69	5.91	0.0135
Ceramics Dry Clay Lab	Classroom*	Student	593	18	533.70	0.37	1.30	0.0030
Ceramics Wet Clay Lab	Classroom*	Student	680	18	612.00	0.43	1.49	0.0034
Kiln Building	Classroom*	Student	466	18	419.40	0.29	1.02	0.0023
R Classroom 28	Classroom*	Student	897	18	807.30	0.56	1.96	0.0045
R Classroom 29	Classroom*	Student	897	18	807.30	0.56	1.96	0.0045
R Classroom 30	Classroom*	Student	897	18	807.30	0.56	1.96	0.0045
R Classroom 31	Classroom*	Student	1,365	18	1,228.50	0.85	2.99	0.0068
Storage 3 Maintenance	Storage	Area	660	0.02	13.20	0.01	0.03	0.0001
Storage 4 Clay	Storage	Area	71	0.02	1.42	0.00	0.00	0.0000
<b>Totals</b>					<b>7,661.92</b>	<b>5.32</b>	<b>18.62</b>	<b>0.0425</b>

\* Assumed 1 Student per

20

SF

\*\*The peak to average flow ration is assumed to be 3.5

# Potable Water Demand

Project Name: Santa Barbara City College

## Existing Wastewater Generation

Building Name	Building Type	Land Use Category	Area	Montly Units (Hundred Cubic Feet/Month/Area)	Generated HCF/Month	Gallons/Month	Gallons/Year	Acre-Feet/Year
<b>Main Campus</b>								
<b>Administration</b>			45,594					
	Classrooms	Institutional	18,000	0.0061	109.98	82,265.04	987,180.48	3.0296
	Laboratories	Institutional	13,535	0.0061	82.70	61,858.74	742,304.88	2.2781
	Offices	Office	14,059	0.0021	28.96	21,663.23	259,958.78	0.7978
<b>Business Communications</b>			22,773					
	Classrooms	Institutional	8,500	0.0061	51.94	38,847.38	466,168.56	1.4306
	Laboratories	Institutional	6,719	0.0061	41.05	30,707.71	368,492.54	1.1309
	Offices	Office	7,554	0.0021	15.56	11,639.81	139,677.69	0.4287
<b>Campus Center</b>			2,330					
	Classrooms	Institutional	2,330	0.0061	14.24	10,648.75	127,785.03	0.3922
	Laboratories	Institutional	-	0.0061	-	-	-	-
	Offices	Office	-	0.0021	-	-	-	-
<b>East Campus Classroom/Office Building</b>			60,000					
	Classrooms	Institutional	30,000	0.0061	183.30	137,108.40	1,645,300.80	5.0493
	Laboratories	Institutional	-	0.0061	-	-	-	-
	Offices	Office	30,000	0.0021	61.80	46,226.40	554,716.80	1.7024
<b>ESL Center</b>			3,091					
	Classrooms	Institutional	-	0.0061	-	-	-	-
	Laboratories	Institutional	-	0.0061	-	-	-	-
	Offices	Office	3,091	0.0021	6.37	4,762.86	57,154.32	0.1754
<b>Humanities</b>			15,940					
	Classrooms	Institutional	9,000	0.0061	54.99	41,132.52	493,590.24	1.5148
	Laboratories	Institutional	5,410	0.0061	33.06	24,725.21	296,702.58	0.9105
	Offices	Office	1,530	0.0021	3.15	2,357.55	28,290.56	0.0868
<b>Interdisciplinary</b>			23,220					
	Classrooms	Institutional	13,900	0.0061	84.93	63,526.89	762,322.70	2.3395
	Laboratories	Institutional	1,600	0.0061	9.78	7,312.45	87,749.38	0.2693
	Offices	Office	7,720	0.0021	15.90	11,895.59	142,747.12	0.4381
<b>Library/LRC</b>			41,007					
	Classrooms	Institutional	-	0.0061	-	-	-	-
	Laboratories	Institutional	-	0.0061	-	-	-	-
	Offices	Office	41,007	0.0021	84.47	63,186.87	758,242.39	2.3270
<b>Occupational Education</b>			14,899					
	Classrooms	Institutional	3,400	0.0061	20.77	15,538.95	186,467.42	0.5722
	Laboratories	Institutional	9,256	0.0061	56.55	42,302.51	507,630.14	1.5579
	Offices	Office	2,243	0.0021	4.62	3,456.19	41,474.33	0.1273
<b>Student Services</b>			18,698					
	Classrooms	Institutional	-	0.0061	-	-	-	-
	Laboratories	Institutional	-	0.0061	-	-	-	-
	Offices	Office	18,698	0.0021	38.52	28,811.37	345,736.49	1.0610
<b>West Campus Classroom Building</b>			22,660					
	Classrooms	Institutional	20,900	0.0061	127.70	95,518.85	1,146,226.22	3.5176
	Laboratories	Institutional	-	0.0061	-	-	-	-
	Offices	Office	1,760	0.0021	3.63	2,711.95	32,543.39	0.0999
<b>Faculty Resources Center</b>			1,824					
	Offices	Office	1,824	0.0021	3.76	2,810.57	33,726.78	0.1035
<b>International Student Services Center</b>			1,259					
	Offices	Office	1,259	0.0021	2.59	1,939.97	23,279.62	0.0714
<b>ECOC1</b>			1,142					
	Offices	Office	1,142	0.0021	2.35	1,759.68	21,116.22	0.0648
<b>ECOC2</b>			1,126					
	Offices	Office	1,126	0.0021	2.32	1,735.03	20,820.37	0.0639
<b>ECOC3</b>			432					
	Offices	Office	432	0.0021	0.89	665.66	7,987.92	0.0245
<b>ECOC4</b>			420					
	Offices	Office	420	0.0021	0.87	647.17	7,766.04	0.0238
<b>ECC-4</b>			1,068					
	Offices	Office	1,068	0.0021	2.20	1,645.66	19,747.92	0.0606
<b>ECC-14</b>			1,196					
	Classrooms	Institutional	1,196	0.0061	7.31	5,466.05	65,592.66	0.2013
<b>ECC-15</b>			1,235					
	Classrooms	Institutional	1,235	0.0061	7.55	5,644.30	67,731.55	0.2079
<b>ECC-16</b>			912					
	Offices	Office	912	0.0021	1.88	1,405.28	16,863.39	0.0518
<b>ECC-17</b>			912					
	Offices	Office	912	0.0021	1.88	1,405.28	16,863.39	0.0518
<b>ECC-18</b>			912					
	Offices	Office	912	0.0021	1.88	1,405.28	16,863.39	0.0518

ECC-19	Offices	Office	912	0.0021	1.88	1,405.28	16,863.39	0.0518
ECC-20	Offices	Office	912	0.0021	1.88	1,405.28	16,863.39	0.0518
ECC-21	Offices	Office	912	0.0021	1.88	1,405.28	16,863.39	0.0518
					-	-	-	-
<b>Totals</b>					<b>1,175.07</b>	<b>878,951.02</b>	<b>10,547,412.25</b>	<b>32.3689</b>

**Schott Campus**

Schott Center Main	Office	Office	16,212	0.0021	33.40	24,980.75	299,768.96	0.9200
Ceramics Dry Clay Lab	Classroom*	Institutional	593	0.0061	3.62	0.00	0.01	0.0000
Ceramics Wet Clay Lab	Classroom*	Institutional	680	0.0061	4.15	0.00	0.01	0.0000
Kiln Building	Classroom*	Institutional	466	0.0061	2.85	0.00	0.01	0.0000
R Classroom 28	Classroom*	Institutional	897	0.0061	5.48	0.00	0.01	0.0000
R Classroom 29	Classroom*	Institutional	897	0.0061	5.48	0.00	0.01	0.0000
R Classroom 30	Classroom*	Institutional	897	0.0061	5.48	0.00	0.01	0.0000
R Classroom 31	Classroom*	Institutional	1,365	0.0061	8.34	0.01	0.02	0.0000
Storage 3 Maintenance	Storage	Office	660	0.0021	1.36	0.00	0.00	0.0000
Storage 4 Clay	Storage	Office	71	0.0021	0.15	0.00	0.00	0.0000
<b>Totals</b>					<b>70.31</b>	<b>24,980.77</b>	<b>299,769.05</b>	<b>0.9202</b>

\* Assumed 1 Student per 35 SF

\*The peak to average flow ration is assumed to be 3.5



---

## 4" VCP @ 1% Slope

---

### Project Description

Friction Method	Kutter Formula
Solve For	Discharge

### Input Data

Roughness Coefficient	0.011	
Channel Slope	0.01000	ft/ft
Normal Depth	0.17	ft
Diameter	0.33	ft

### Results

Discharge	0.10	ft <sup>3</sup> /s
Flow Area	0.04	ft <sup>2</sup>
Wetted Perimeter	0.52	ft
Hydraulic Radius	0.08	ft
Top Width	0.33	ft
Critical Depth	0.18	ft
Percent Full	50.0	%
Critical Slope	0.00811	ft/ft
Velocity	2.30	ft/s
Velocity Head	0.08	ft
Specific Energy	0.25	ft
Froude Number	1.12	
Maximum Discharge	0.22	ft <sup>3</sup> /s
Discharge Full	0.20	ft <sup>3</sup> /s
Slope Full	0.00253	ft/ft
Flow Type	SuperCritical	

### GVF Input Data

Downstream Depth	0.00	ft
Length	0.00	ft
Number Of Steps	0	

### GVF Output Data

Upstream Depth	0.00	ft
Profile Description		
Profile Headloss	0.00	ft
Average End Depth Over Rise	0.00	%
Normal Depth Over Rise	50.00	%
Downstream Velocity	Infinity	ft/s

---

## 4" VCP @ 1% Slope

---

### GVF Output Data

Upstream Velocity	Infinity	ft/s
Normal Depth	0.17	ft
Critical Depth	0.18	ft
Channel Slope	0.01000	ft/ft
Critical Slope	0.00811	ft/ft

---

## 4" VCP @ 2% Slope

---

### Project Description

Friction Method	Kutter Formula
Solve For	Discharge

### Input Data

Roughness Coefficient	0.011	
Channel Slope	0.02000	ft/ft
Normal Depth	0.17	ft
Diameter	0.33	ft

### Results

Discharge	0.14	ft <sup>3</sup> /s
Flow Area	0.04	ft <sup>2</sup>
Wetted Perimeter	0.52	ft
Hydraulic Radius	0.08	ft
Top Width	0.33	ft
Critical Depth	0.21	ft
Percent Full	50.0	%
Critical Slope	0.00901	ft/ft
Velocity	3.25	ft/s
Velocity Head	0.16	ft
Specific Energy	0.33	ft
Froude Number	1.58	
Maximum Discharge	0.31	ft <sup>3</sup> /s
Discharge Full	0.28	ft <sup>3</sup> /s
Slope Full	0.00507	ft/ft
Flow Type	SuperCritical	

### GVF Input Data

Downstream Depth	0.00	ft
Length	0.00	ft
Number Of Steps	0	

### GVF Output Data

Upstream Depth	0.00	ft
Profile Description		
Profile Headloss	0.00	ft
Average End Depth Over Rise	0.00	%
Normal Depth Over Rise	50.00	%
Downstream Velocity	Infinity	ft/s

---

## 4" VCP @ 2% Slope

---

### GVF Output Data

Upstream Velocity	Infinity	ft/s
Normal Depth	0.17	ft
Critical Depth	0.21	ft
Channel Slope	0.02000	ft/ft
Critical Slope	0.00901	ft/ft

---

## 6" VCP @ 1% Slope

---

### Project Description

Friction Method	Kutter Formula
Solve For	Discharge

### Input Data

Roughness Coefficient	0.011	
Channel Slope	0.01000	ft/ft
Normal Depth	0.25	ft
Diameter	0.50	ft

### Results

Discharge	0.31	ft <sup>3</sup> /s
Flow Area	0.10	ft <sup>2</sup>
Wetted Perimeter	0.79	ft
Hydraulic Radius	0.13	ft
Top Width	0.50	ft
Critical Depth	0.28	ft
Percent Full	50.0	%
Critical Slope	0.00660	ft/ft
Velocity	3.17	ft/s
Velocity Head	0.16	ft
Specific Energy	0.41	ft
Froude Number	1.26	
Maximum Discharge	0.68	ft <sup>3</sup> /s
Discharge Full	0.62	ft <sup>3</sup> /s
Slope Full	0.00254	ft/ft
Flow Type	SuperCritical	

### GVF Input Data

Downstream Depth	0.00	ft
Length	0.00	ft
Number Of Steps	0	

### GVF Output Data

Upstream Depth	0.00	ft
Profile Description		
Profile Headloss	0.00	ft
Average End Depth Over Rise	0.00	%
Normal Depth Over Rise	50.00	%
Downstream Velocity	Infinity	ft/s

---

## 6" VCP @ 1% Slope

---

### GVF Output Data

Upstream Velocity	Infinity	ft/s
Normal Depth	0.25	ft
Critical Depth	0.28	ft
Channel Slope	0.01000	ft/ft
Critical Slope	0.00660	ft/ft

---

## 6" VCP @ 2% Slope

---

### Project Description

Friction Method	Kutter Formula
Solve For	Discharge

### Input Data

Roughness Coefficient	0.011	
Channel Slope	0.02000	ft/ft
Normal Depth	0.25	ft
Diameter	0.50	ft

### Results

Discharge	0.44	ft <sup>3</sup> /s
Flow Area	0.10	ft <sup>2</sup>
Wetted Perimeter	0.79	ft
Hydraulic Radius	0.13	ft
Top Width	0.50	ft
Critical Depth	0.34	ft
Percent Full	50.0	%
Critical Slope	0.00759	ft/ft
Velocity	4.49	ft/s
Velocity Head	0.31	ft
Specific Energy	0.56	ft
Froude Number	1.79	
Maximum Discharge	0.96	ft <sup>3</sup> /s
Discharge Full	0.88	ft <sup>3</sup> /s
Slope Full	0.00505	ft/ft
Flow Type	SuperCritical	

### GVF Input Data

Downstream Depth	0.00	ft
Length	0.00	ft
Number Of Steps	0	

### GVF Output Data

Upstream Depth	0.00	ft
Profile Description		
Profile Headloss	0.00	ft
Average End Depth Over Rise	0.00	%
Normal Depth Over Rise	50.00	%
Downstream Velocity	Infinity	ft/s

---

## 6" VCP @ 2% Slope

---

### GVF Output Data

Upstream Velocity	Infinity	ft/s
Normal Depth	0.25	ft
Critical Depth	0.34	ft
Channel Slope	0.02000	ft/ft
Critical Slope	0.00759	ft/ft



---

## 8" VCP @ 1% Slope

---

### Project Description

Friction Method	Kutter Formula
Solve For	Discharge

### Input Data

Roughness Coefficient	0.011	
Channel Slope	0.01000	ft/ft
Normal Depth	0.33	ft
Diameter	0.67	ft

### Results

Discharge	0.69	ft <sup>3</sup> /s
Flow Area	0.17	ft <sup>2</sup>
Wetted Perimeter	1.05	ft
Hydraulic Radius	0.17	ft
Top Width	0.67	ft
Critical Depth	0.39	ft
Percent Full	50.0	%
Critical Slope	0.00580	ft/ft
Velocity	3.96	ft/s
Velocity Head	0.24	ft
Specific Energy	0.58	ft
Froude Number	1.36	
Maximum Discharge	1.51	ft <sup>3</sup> /s
Discharge Full	1.38	ft <sup>3</sup> /s
Slope Full	0.00254	ft/ft
Flow Type	SuperCritical	

### GVF Input Data

Downstream Depth	0.00	ft
Length	0.00	ft
Number Of Steps	0	

### GVF Output Data

Upstream Depth	0.00	ft
Profile Description		
Profile Headloss	0.00	ft
Average End Depth Over Rise	0.00	%
Normal Depth Over Rise	50.00	%
Downstream Velocity	Infinity	ft/s

---

## 8" VCP @ 1% Slope

---

### GVF Output Data

Upstream Velocity	Infinity	ft/s
Normal Depth	0.33	ft
Critical Depth	0.39	ft
Channel Slope	0.01000	ft/ft
Critical Slope	0.00580	ft/ft

---

## 8" VCP @ 2% Slope

---

### Project Description

Friction Method	Kutter Formula
Solve For	Discharge

### Input Data

Roughness Coefficient	0.011	
Channel Slope	0.02000	ft/ft
Normal Depth	0.33	ft
Diameter	0.67	ft

### Results

Discharge	0.98	ft <sup>3</sup> /s
Flow Area	0.17	ft <sup>2</sup>
Wetted Perimeter	1.05	ft
Hydraulic Radius	0.17	ft
Top Width	0.67	ft
Critical Depth	0.47	ft
Percent Full	50.0	%
Critical Slope	0.00684	ft/ft
Velocity	5.61	ft/s
Velocity Head	0.49	ft
Specific Energy	0.82	ft
Froude Number	1.93	
Maximum Discharge	2.13	ft <sup>3</sup> /s
Discharge Full	1.96	ft <sup>3</sup> /s
Slope Full	0.00504	ft/ft
Flow Type	SuperCritical	

### GVF Input Data

Downstream Depth	0.00	ft
Length	0.00	ft
Number Of Steps	0	

### GVF Output Data

Upstream Depth	0.00	ft
Profile Description		
Profile Headloss	0.00	ft
Average End Depth Over Rise	0.00	%
Normal Depth Over Rise	50.00	%
Downstream Velocity	Infinity	ft/s

---

## 8" VCP @ 2% Slope

---

### GVF Output Data

Upstream Velocity	Infinity	ft/s
Normal Depth	0.33	ft
Critical Depth	0.47	ft
Channel Slope	0.02000	ft/ft
Critical Slope	0.00684	ft/ft

---

## 10" VCP @ 1% Slope

---

### Project Description

Friction Method	Kutter Formula
Solve For	Discharge

### Input Data

Roughness Coefficient	0.011	
Channel Slope	0.01000	ft/ft
Normal Depth	0.42	ft
Diameter	0.83	ft

### Results

Discharge	1.28	ft <sup>3</sup> /s
Flow Area	0.27	ft <sup>2</sup>
Wetted Perimeter	1.31	ft
Hydraulic Radius	0.21	ft
Top Width	0.83	ft
Critical Depth	0.51	ft
Percent Full	50.0	%
Critical Slope	0.00529	ft/ft
Velocity	4.69	ft/s
Velocity Head	0.34	ft
Specific Energy	0.76	ft
Froude Number	1.45	
Maximum Discharge	2.78	ft <sup>3</sup> /s
Discharge Full	2.56	ft <sup>3</sup> /s
Slope Full	0.00253	ft/ft
Flow Type	SuperCritical	

### GVF Input Data

Downstream Depth	0.00	ft
Length	0.00	ft
Number Of Steps	0	

### GVF Output Data

Upstream Depth	0.00	ft
Profile Description		
Profile Headloss	0.00	ft
Average End Depth Over Rise	0.00	%
Normal Depth Over Rise	50.00	%
Downstream Velocity	Infinity	ft/s

---

## 10" VCP @ 1% Slope

---

### GVF Output Data

Upstream Velocity	Infinity	ft/s
Normal Depth	0.42	ft
Critical Depth	0.51	ft
Channel Slope	0.01000	ft/ft
Critical Slope	0.00529	ft/ft

---

## 10" VCP @ 2% Slope

---

### Project Description

Friction Method	Kutter Formula
Solve For	Discharge

### Input Data

Roughness Coefficient	0.011	
Channel Slope	0.02000	ft/ft
Normal Depth	0.42	ft
Diameter	0.83	ft

### Results

Discharge	1.81	ft <sup>3</sup> /s
Flow Area	0.27	ft <sup>2</sup>
Wetted Perimeter	1.31	ft
Hydraulic Radius	0.21	ft
Top Width	0.83	ft
Critical Depth	0.60	ft
Percent Full	50.0	%
Critical Slope	0.00637	ft/ft
Velocity	6.64	ft/s
Velocity Head	0.68	ft
Specific Energy	1.10	ft
Froude Number	2.05	
Maximum Discharge	3.94	ft <sup>3</sup> /s
Discharge Full	3.62	ft <sup>3</sup> /s
Slope Full	0.00503	ft/ft
Flow Type	SuperCritical	

### GVF Input Data

Downstream Depth	0.00	ft
Length	0.00	ft
Number Of Steps	0	

### GVF Output Data

Upstream Depth	0.00	ft
Profile Description		
Profile Headloss	0.00	ft
Average End Depth Over Rise	0.00	%
Normal Depth Over Rise	50.00	%
Downstream Velocity	Infinity	ft/s

---

## 10" VCP @ 2% Slope

---

### GVF Output Data

Upstream Velocity	Infinity	ft/s
Normal Depth	0.42	ft
Critical Depth	0.60	ft
Channel Slope	0.02000	ft/ft
Critical Slope	0.00637	ft/ft



---

## Required RCP Diameter @ 0.5% Slope

---

### Project Description

Friction Method	Kutter Formula
Solve For	Full Flow Diameter

### Input Data

Roughness Coefficient	0.013	
Channel Slope	0.00500	ft/ft
Normal Depth	5.12	ft
Diameter	5.12	ft
Discharge	201.00	ft <sup>3</sup> /s

### Results

Diameter	5.12	ft
Normal Depth	5.12	ft
Flow Area	20.57	ft <sup>2</sup>
Wetted Perimeter	16.08	ft
Hydraulic Radius	1.28	ft
Top Width	0.00	ft
Critical Depth	4.03	ft
Percent Full	100.0	%
Critical Slope	0.00541	ft/ft
Velocity	9.77	ft/s
Velocity Head	1.48	ft
Specific Energy	6.60	ft
Froude Number	0.00	
Maximum Discharge	216.00	ft <sup>3</sup> /s
Discharge Full	201.02	ft <sup>3</sup> /s
Slope Full	0.00499	ft/ft
Flow Type	SubCritical	

### GVF Input Data

Downstream Depth	0.00	ft
Length	0.00	ft
Number Of Steps	0	

### GVF Output Data

Upstream Depth	0.00	ft
Profile Description		
Profile Headloss	0.00	ft
Average End Depth Over Rise	0.00	%

---

## Required RCP Diameter @ 0.5% Slope

---

### GVF Output Data

Normal Depth Over Rise	100.00	%
Downstream Velocity	Infinity	ft/s
Upstream Velocity	Infinity	ft/s
Normal Depth	5.12	ft
Critical Depth	4.03	ft
Channel Slope	0.00500	ft/ft
Critical Slope	0.00541	ft/ft

---

## Required RCP Diameter @ 1% Slope

---

### Project Description

Friction Method	Kutter Formula
Solve For	Full Flow Diameter

### Input Data

Roughness Coefficient	0.013	
Channel Slope	0.01000	ft/ft
Normal Depth	4.49	ft
Diameter	4.49	ft
Discharge	201.00	ft <sup>3</sup> /s

### Results

Diameter	4.49	ft
Normal Depth	4.49	ft
Flow Area	15.85	ft <sup>2</sup>
Wetted Perimeter	14.11	ft
Hydraulic Radius	1.12	ft
Top Width	0.00	ft
Critical Depth	4.04	ft
Percent Full	100.0	%
Critical Slope	0.00881	ft/ft
Velocity	12.68	ft/s
Velocity Head	2.50	ft
Specific Energy	6.99	ft
Froude Number	0.00	
Maximum Discharge	216.19	ft <sup>3</sup> /s
Discharge Full	201.00	ft <sup>3</sup> /s
Slope Full	0.01001	ft/ft
Flow Type	SubCritical	

### GVF Input Data

Downstream Depth	0.00	ft
Length	0.00	ft
Number Of Steps	0	

### GVF Output Data

Upstream Depth	0.00	ft
Profile Description		
Profile Headloss	0.00	ft
Average End Depth Over Rise	0.00	%

---

## Required RCP Diameter @ 1% Slope

---

### GVF Output Data

Normal Depth Over Rise	100.00	%
Downstream Velocity	Infinity	ft/s
Upstream Velocity	Infinity	ft/s
Normal Depth	4.49	ft
Critical Depth	4.04	ft
Channel Slope	0.01000	ft/ft
Critical Slope	0.00881	ft/ft

---

## Required RCP Diameter @ 1.5% Slope

---

### Project Description

Friction Method	Kutter Formula
Solve For	Full Flow Diameter

### Input Data

Roughness Coefficient	0.013	
Channel Slope	0.01500	ft/ft
Normal Depth	4.16	ft
Diameter	4.16	ft
Discharge	201.00	ft <sup>3</sup> /s

### Results

Diameter	4.16	ft
Normal Depth	4.16	ft
Flow Area	13.61	ft <sup>2</sup>
Wetted Perimeter	13.08	ft
Hydraulic Radius	1.04	ft
Top Width	0.00	ft
Critical Depth	3.94	ft
Percent Full	100.0	%
Critical Slope	0.01298	ft/ft
Velocity	14.76	ft/s
Velocity Head	3.39	ft
Specific Energy	7.55	ft
Froude Number	0.00	
Maximum Discharge	216.30	ft <sup>3</sup> /s
Discharge Full	200.99	ft <sup>3</sup> /s
Slope Full	0.01501	ft/ft
Flow Type	SubCritical	

### GVF Input Data

Downstream Depth	0.00	ft
Length	0.00	ft
Number Of Steps	0	

### GVF Output Data

Upstream Depth	0.00	ft
Profile Description		
Profile Headloss	0.00	ft
Average End Depth Over Rise	0.00	%

---

## Required RCP Diameter @ 1.5% Slope

---

### GVF Output Data

Normal Depth Over Rise	100.00	%
Downstream Velocity	Infinity	ft/s
Upstream Velocity	Infinity	ft/s
Normal Depth	4.16	ft
Critical Depth	3.94	ft
Channel Slope	0.01500	ft/ft
Critical Slope	0.01298	ft/ft

## Required RCP Diameter @ 2% Slope

### Project Description

Friction Method	Kutter Formula
Solve For	Full Flow Diameter

### Input Data

Roughness Coefficient	0.013	
Channel Slope	0.02000	ft/ft
Normal Depth	3.95	ft
Diameter	3.95	ft
Discharge	201.00	ft <sup>3</sup> /s

### Results

Diameter	3.95	ft
Normal Depth	3.95	ft
Flow Area	12.23	ft <sup>2</sup>
Wetted Perimeter	12.39	ft
Hydraulic Radius	0.99	ft
Top Width	0.00	ft
Critical Depth	3.81	ft
Percent Full	100.0	%
Critical Slope	0.01753	ft/ft
Velocity	16.44	ft/s
Velocity Head	4.20	ft
Specific Energy	8.15	ft
Froude Number	0.00	
Maximum Discharge	216.41	ft <sup>3</sup> /s
Discharge Full	201.00	ft <sup>3</sup> /s
Slope Full	0.01999	ft/ft
Flow Type	SubCritical	

### GVF Input Data

Downstream Depth	0.00	ft
Length	0.00	ft
Number Of Steps	0	

### GVF Output Data

Upstream Depth	0.00	ft
Profile Description		
Profile Headloss	0.00	ft
Average End Depth Over Rise	0.00	%

---

## Required RCP Diameter @ 2% Slope

---

### GVF Output Data

Normal Depth Over Rise	100.00	%
Downstream Velocity	Infinity	ft/s
Upstream Velocity	Infinity	ft/s
Normal Depth	3.95	ft
Critical Depth	3.81	ft
Channel Slope	0.02000	ft/ft
Critical Slope	0.01753	ft/ft